

plumbworld

Big brands, small prices.

Large Radiator Cover with 3 Drawers

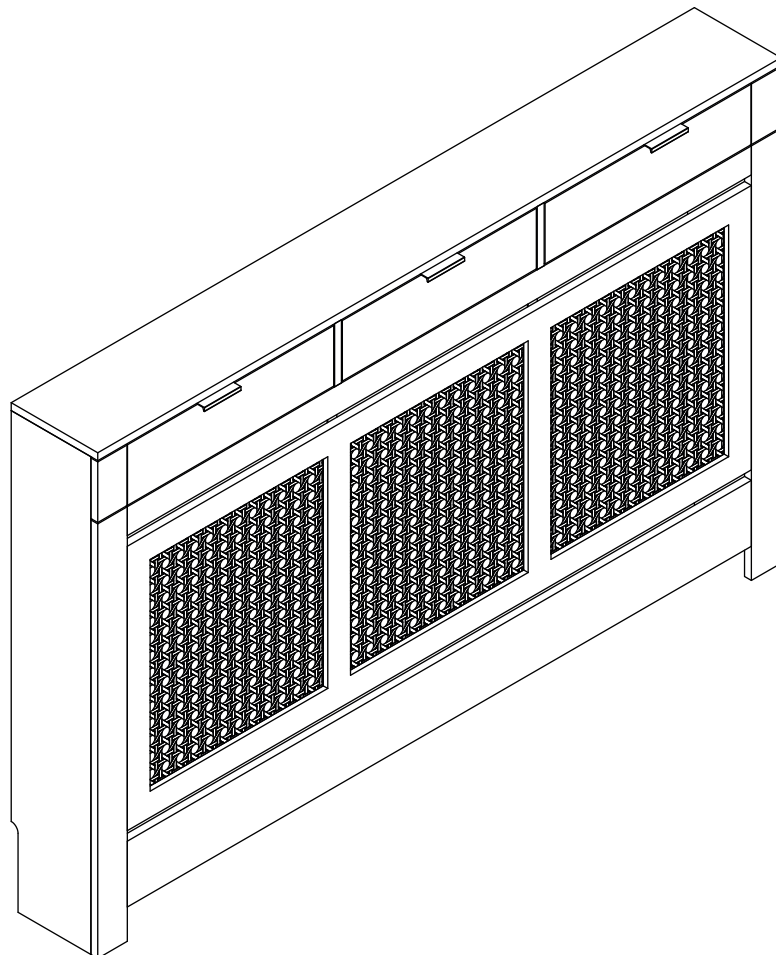

Assembly instructions- Please keep for future reference

PWLPRADC15

PWLPRADC18

Issue 1 - 24/11/22

Safety and Care Advice

IMPORTANT, RETAIN FOR FUTURE REFERENCE: READ CAREFULLY.

- Keep children and animals away from the work area small parts are a choking hazard if swallowed.
- Make sure you have enough space to layout the parts before starting.
- This product has been constructed to be used in the domestic environment only and not for commercial purposes.

- Assemble the item as close to its final position (in the same room) as possible.
- Assemble on a soft level surface to avoid damaging the unit or your floor.
- The surface should be protected from liquids, heat or cold by using a coaster or mat. The surface is not water resistant and may be damaged or discoloured if not protected.



- We do not recommend the use of power drill/drivers for inserting screws as this could damage the unit. Only use

hand screwdrivers.

- Parts of the assembly will be easier with 2 people.
- Dispose of all packaging carefully and responsibly.

Care and maintenance

-
- Only clean using a damp cloth and mild detergent. Do not use abrasive cleaners.

- From time to time check that there are no loose screws, nuts or bolts. If there are please re-tighten.

- This product should not be discarded with household waste. Take to your local authority waste disposal centre.

Additional Guidance

-
- Assemble all parts and bolts loosely during assembly, only once the product is complete should you fully tighten the bolts.
 - Regularly check and ensure that all bolts and fittings are tightened properly.

WARNING!
IN ORDER TO PREVENT OVERTURNING THIS PRODUCT MUST BE USED WITH THE WALL ATTACHMENT DEVICE PROVIDED

Serious or fatal crushing injuries can occur from furniture tipping over. To help prevent this item of furniture tipping over:

- Use the wall attachment device provided.
- Do not let children climb or hang on drawers, doors or shelves.
- Place the heaviest items in the lower drawers or shelves.
- Do not place TV's or other heavy objects on top of this product, unless it has been specifically designed to support them.
- Never open more than one drawer at a time.

An attachment device is provided with your product, however you will need to source suitable fixings for your wall type. If in doubt, please consult a qualified tradesperson. Always ensure the wall to be drilled is free from hidden electrical wires, water and gas pipes.

Fittings

Please check that you have all the fittings listed below:

NOTE: The quantities below are the correct amount to complete the assembly. In some cases more fittings may be supplied than required.

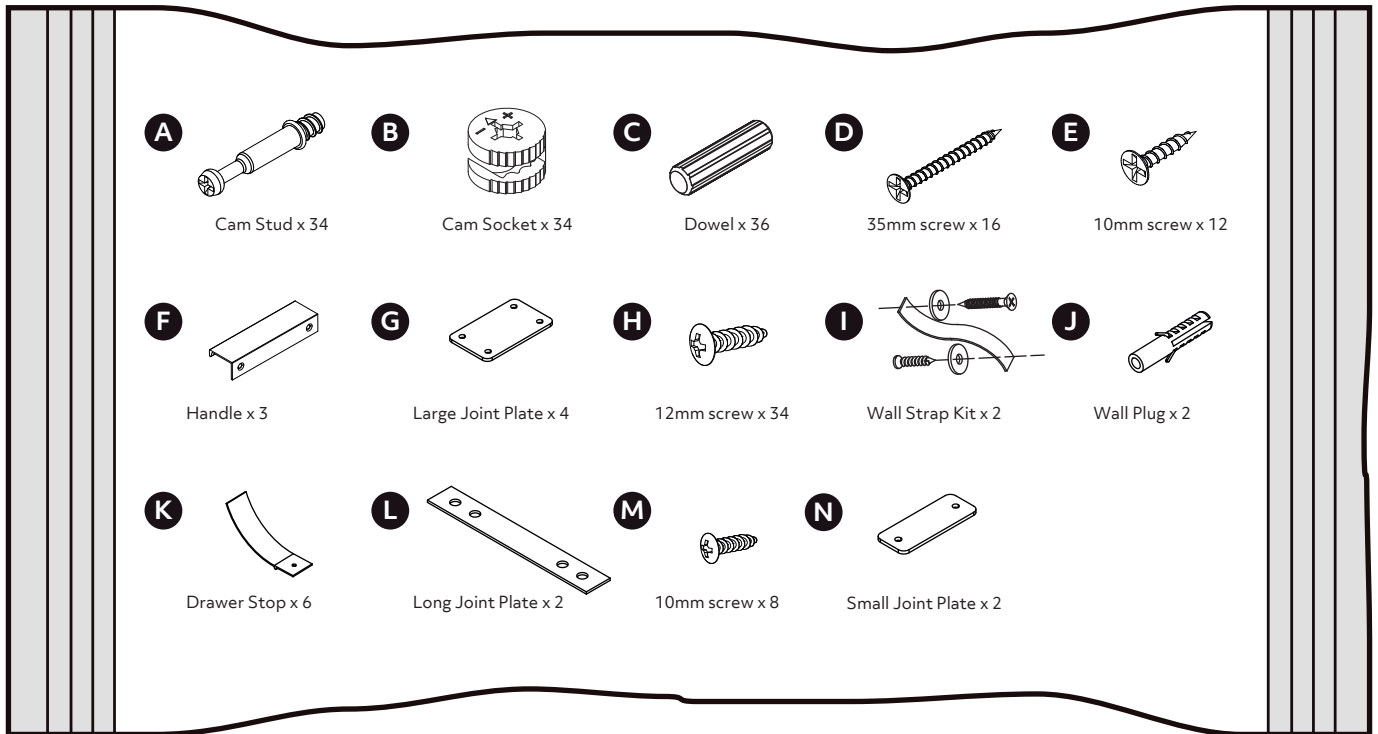

Tools required

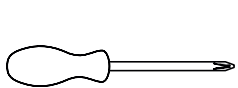

Crosshead screwdriver
(small & medium)



Flathead screwdriver
(small & medium)

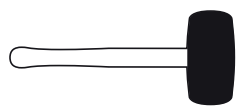

Mallet



Ruler/tape
measure

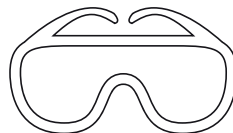

Eye protection
(when using a hammer or
glue)

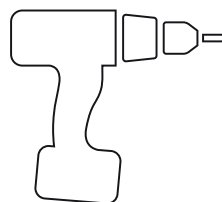

Power drill

Panels

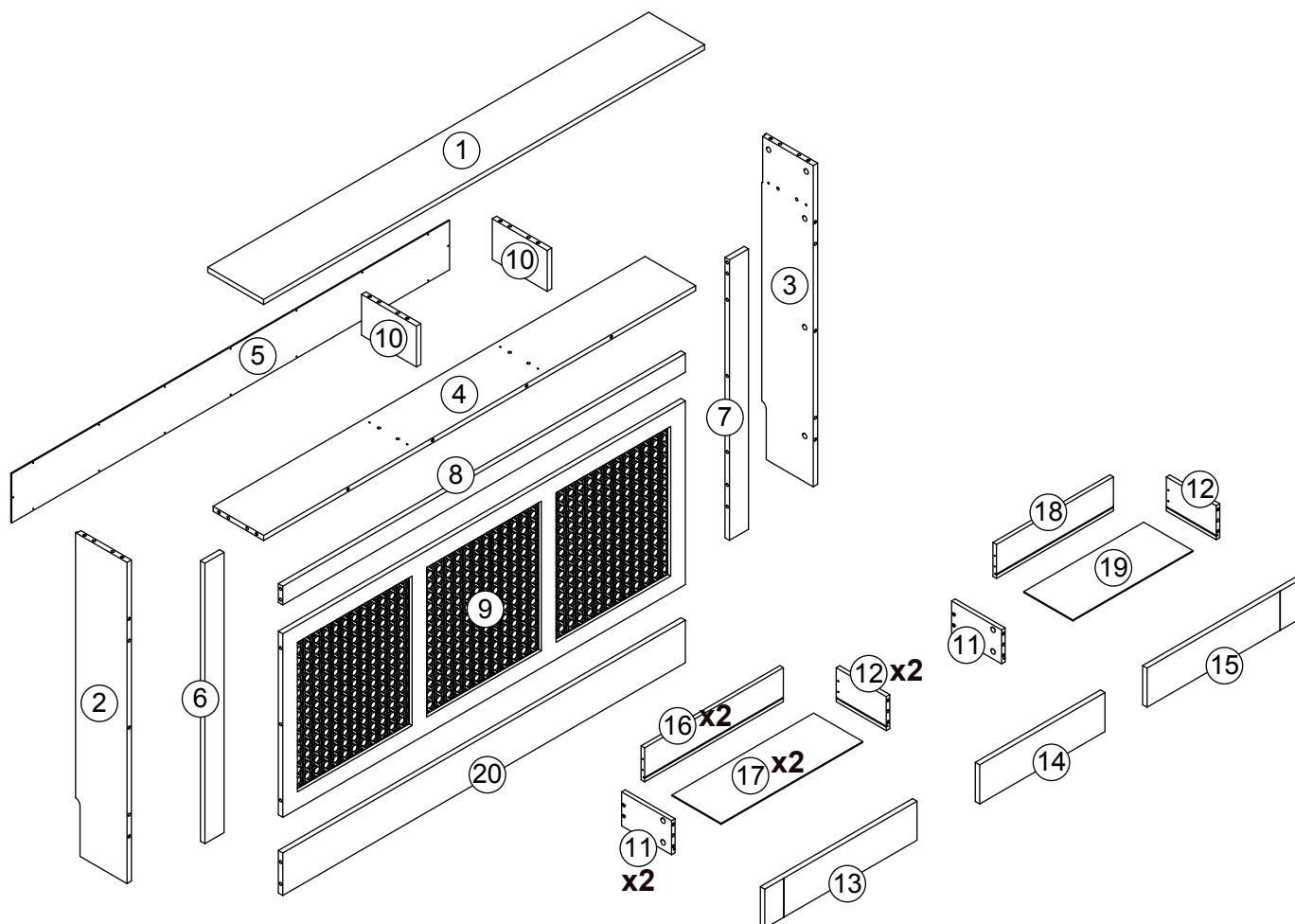

Panel List

1.	Top panel	150 x 19 x 1.5 cm	x 1
2.	Left side panel	94.5 x 17.8 x 1.2 cm	x 1
3.	Right side panel	94.5 x 17.8 x 1.2 cm	x 1
4.	Horizontal panel	147 x 17.5 x 1.2 cm	x 1
5.	Back panel	149 x 14.5 x 0.3 cm	x 1
6.	Face left side panel	75 x 6.5 x 1.2 cm	x 1
7.	Face right side panel	75 x 6.5 x 1.2 cm	x 1
8.	Face support bar	137 x 5.5 x 1.2 cm	x 1
9.	Face decorate panel	137 x 54 x 1.2 cm	x 1
10.	Middle panel	18.5 x 12 x 1.2 cm	x 2
11.	Drawer left side panel	17.2 x 10 x 1.2 cm	x 3
12.	Drawer right side panel	17.2 x 10 x 1.2 cm	x 3
13.	Drawer left face panel	52 x 11.5 x 1.2 cm	x 1
14.	Drawer middle face panel	42 x 11.5 x 1.2 cm	x 1
15.	Drawer right face panel	52 x 11.5 x 1.2 cm	x 1
16.	Drawer back panel	47.6 x 10 x 1.2 cm	x 2
17.	Drawer bottom panel	48.6 x 16.7 x 0.3 cm	x 2
18.	Drawer back panel	39.4 x 10 x 1.2 cm	x 1
19.	Drawer bottom panel	40.4 x 16.7 x 0.3 cm	x 1
20.	Face support bar	137 x 12.5 x 1.2 cm	x 1

1

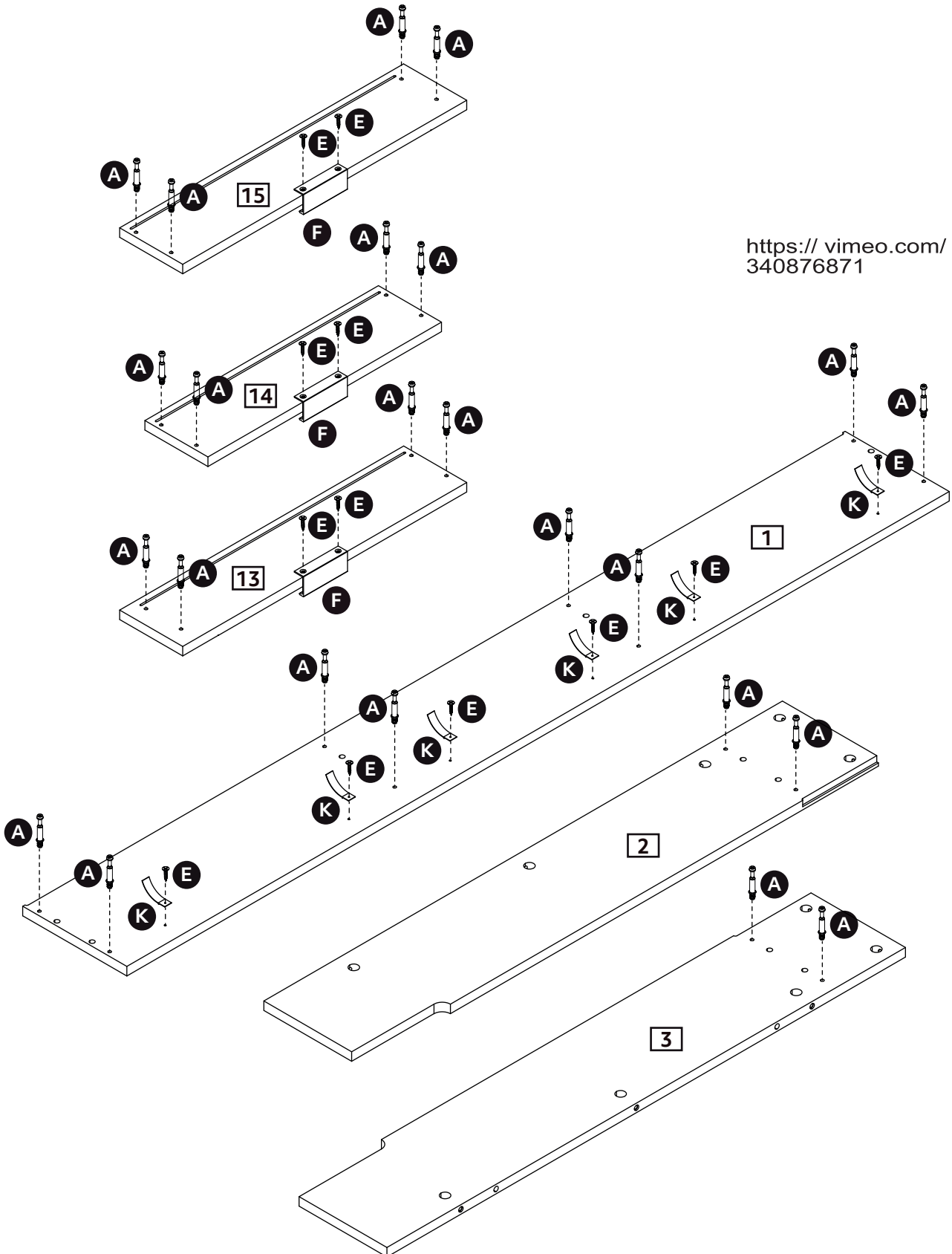
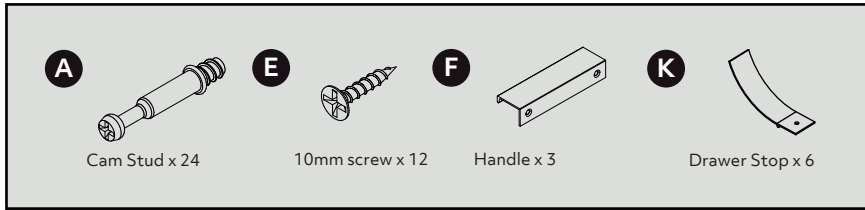

2

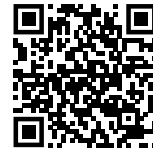
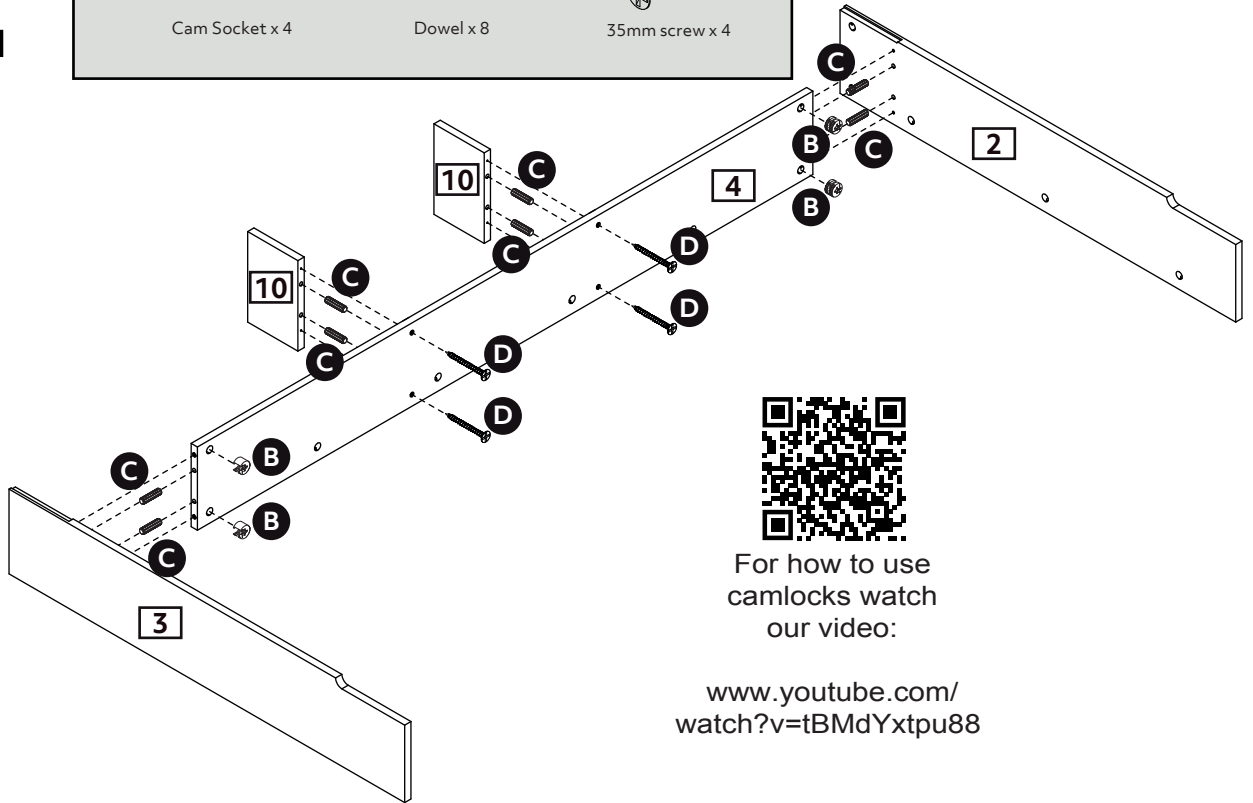
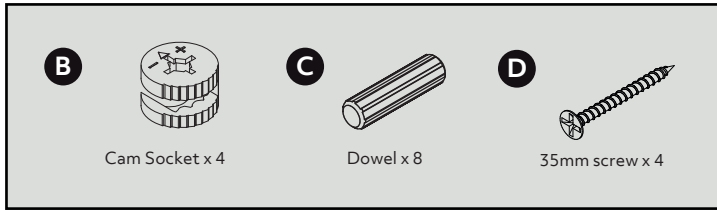

For how to use
camlocks watch
our video:

[www.youtube.com/
watch?v=tBMdYxtpu88](http://www.youtube.com/watch?v=tBMdYxtpu88)

3

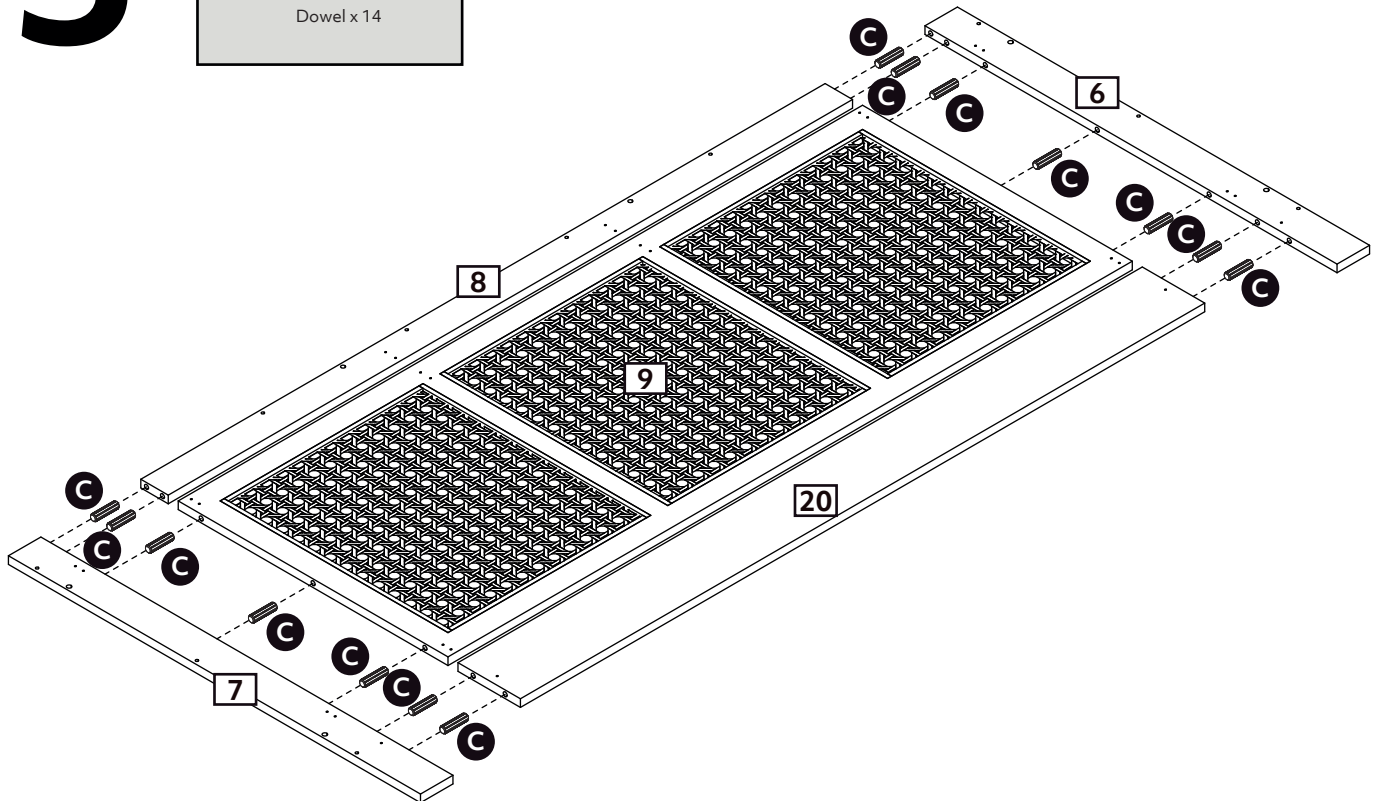
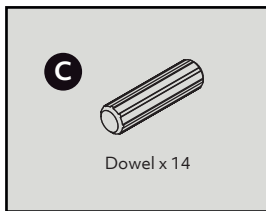

4

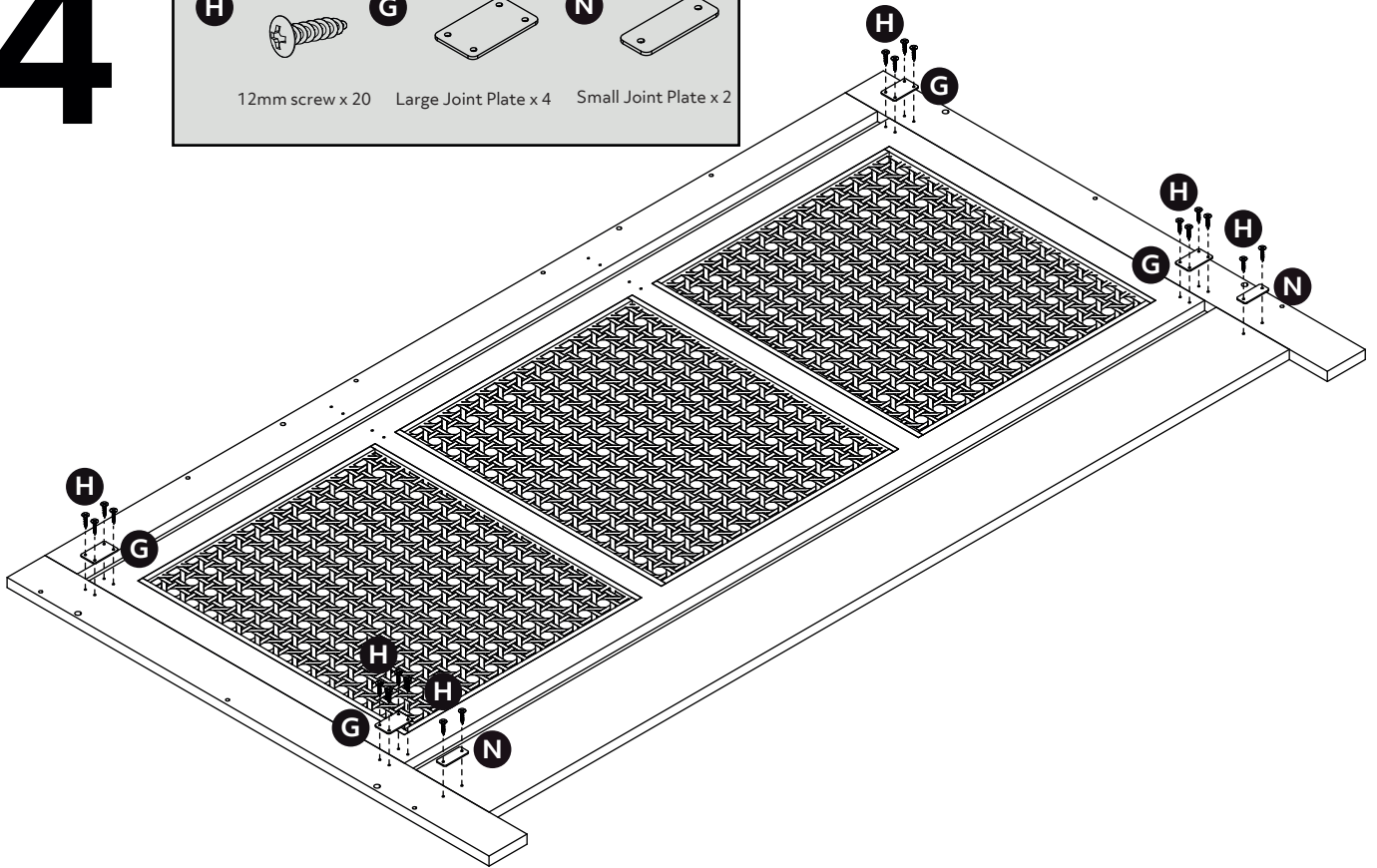
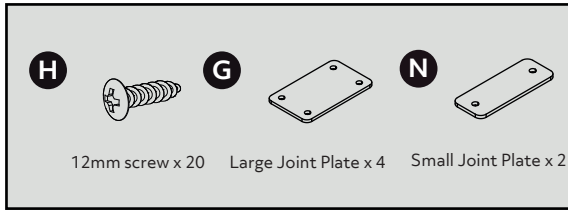

5

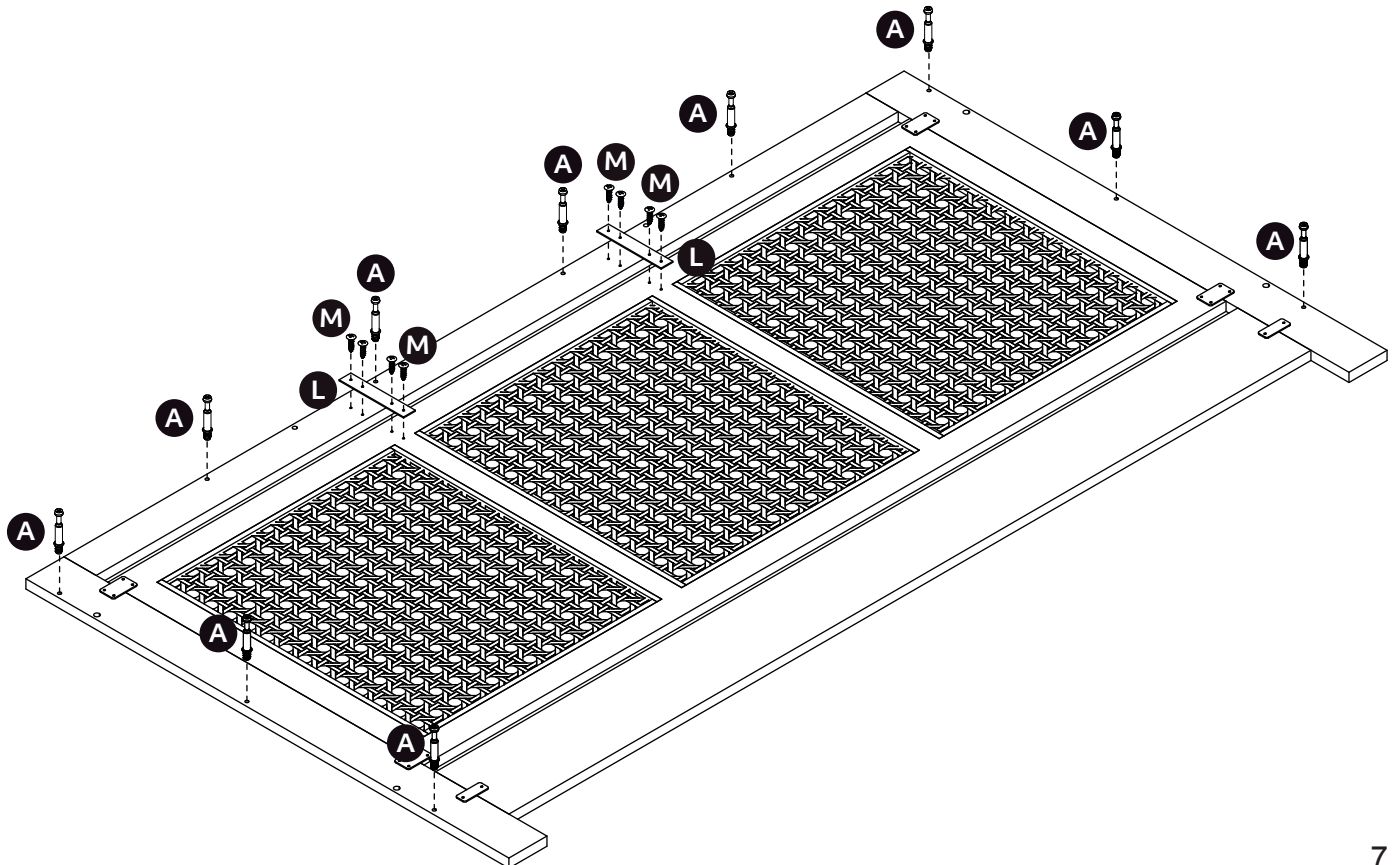
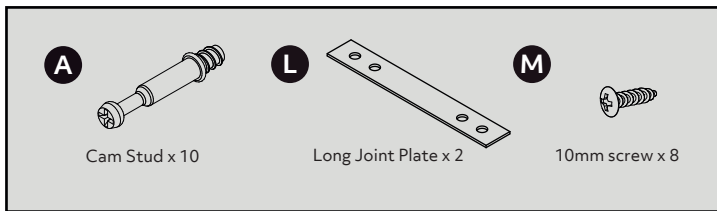

6

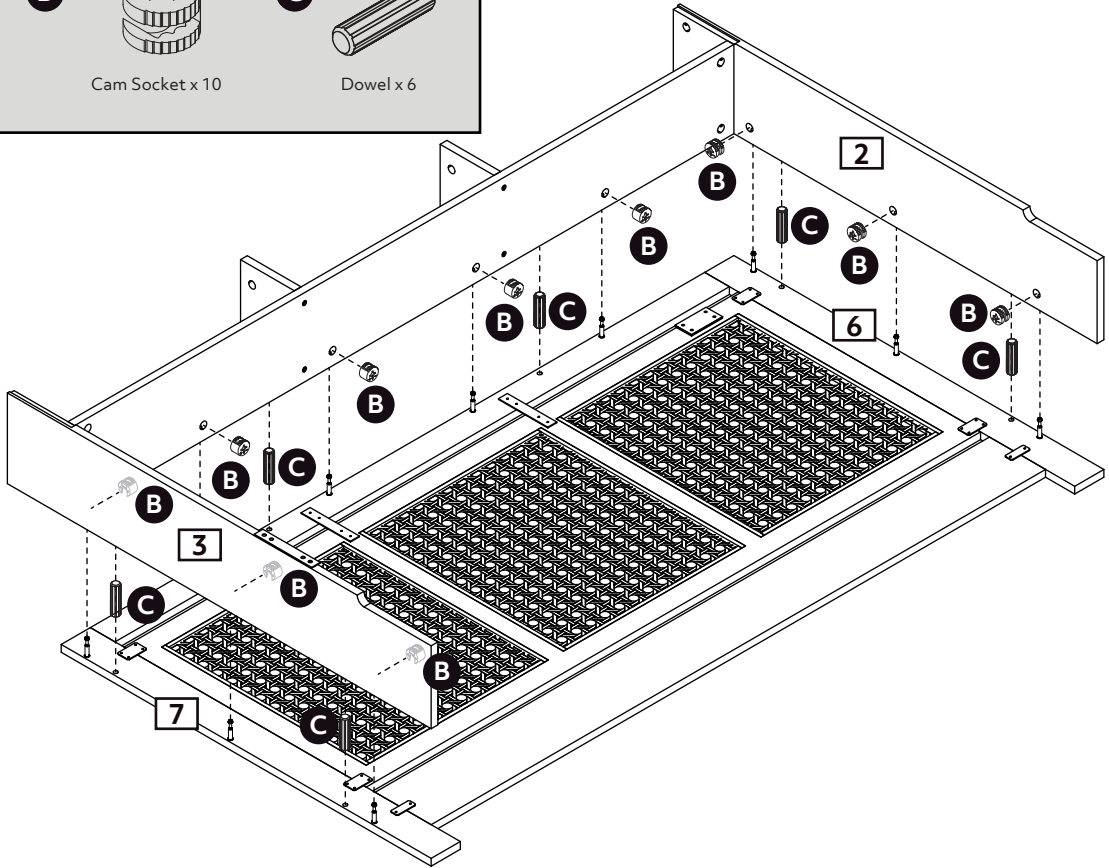
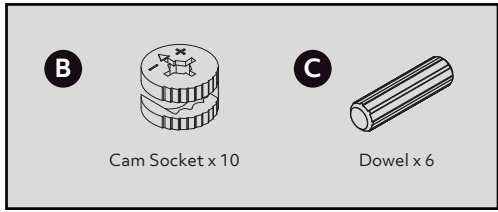

7

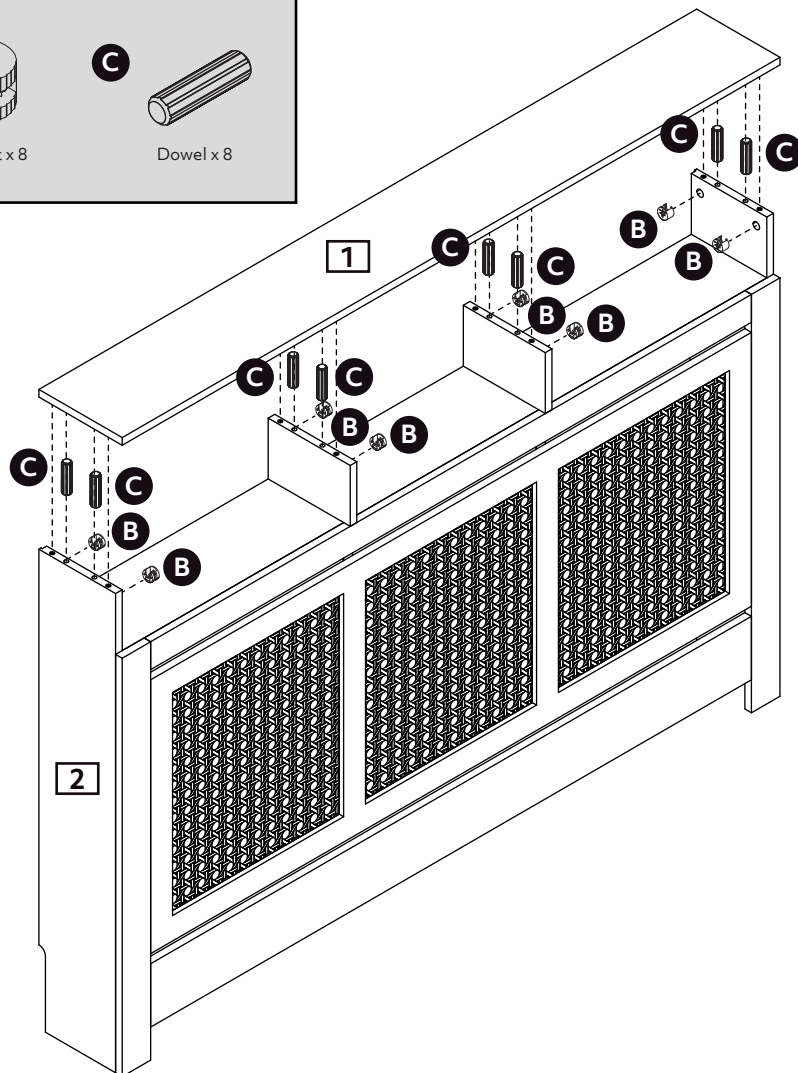
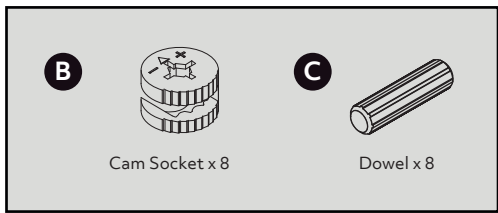

8

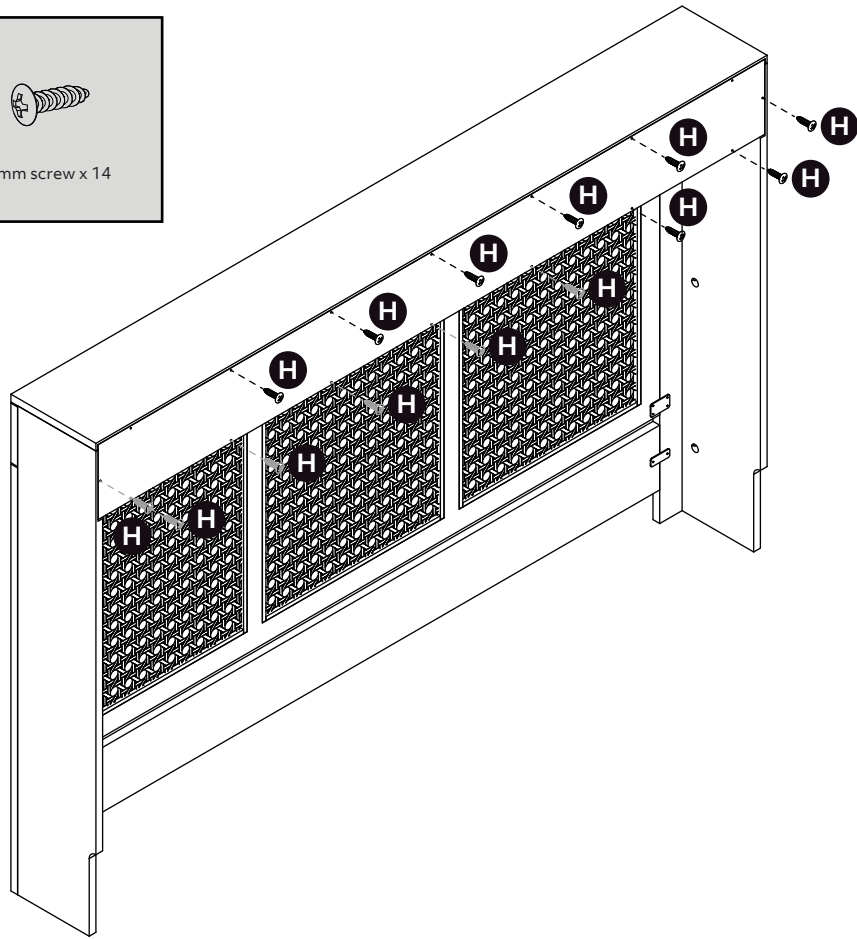
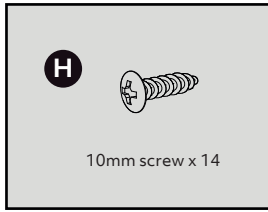

9

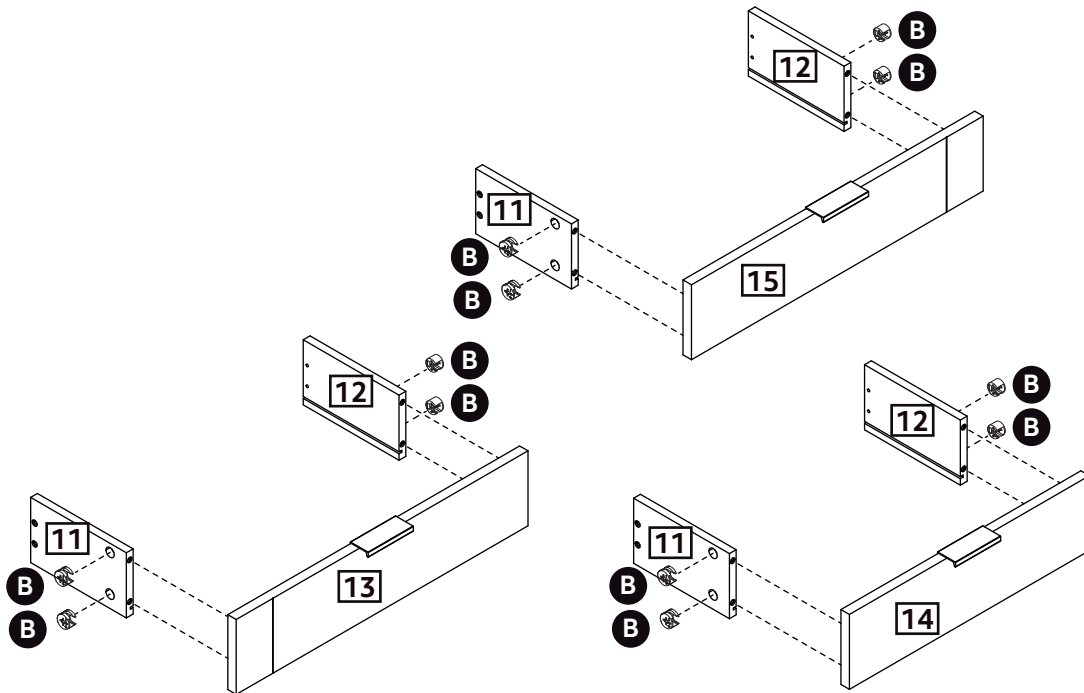
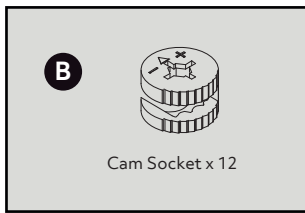

10

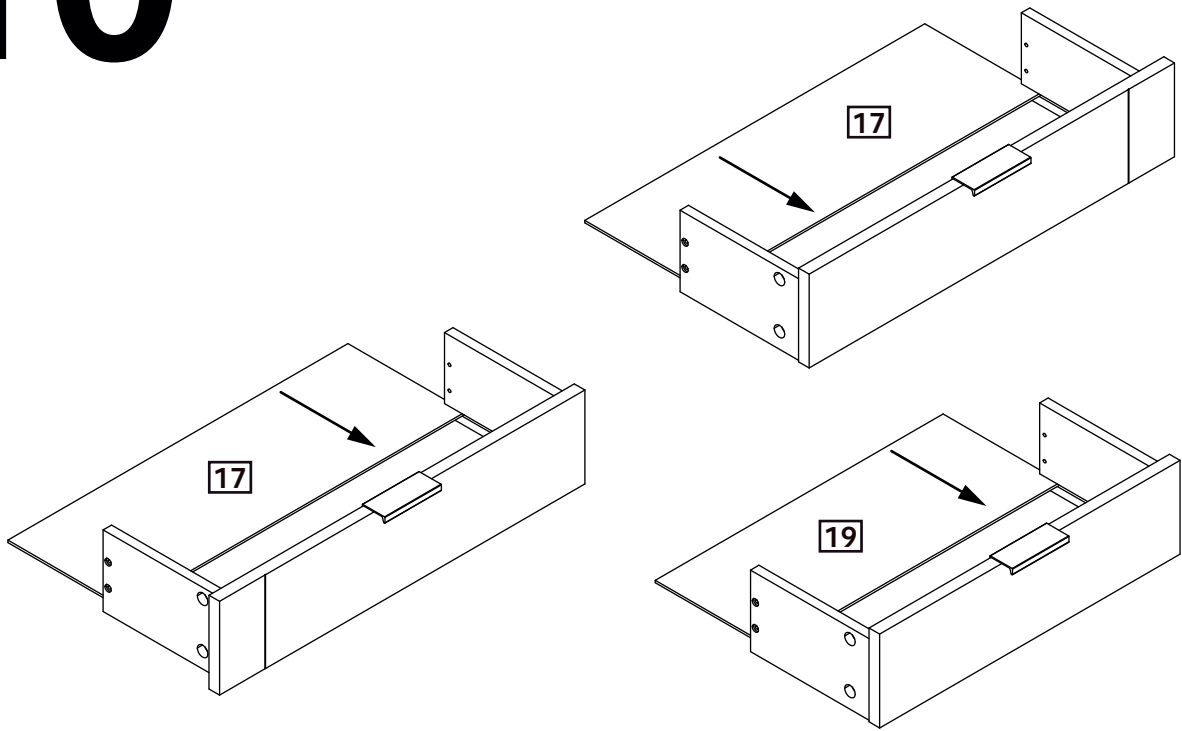

11

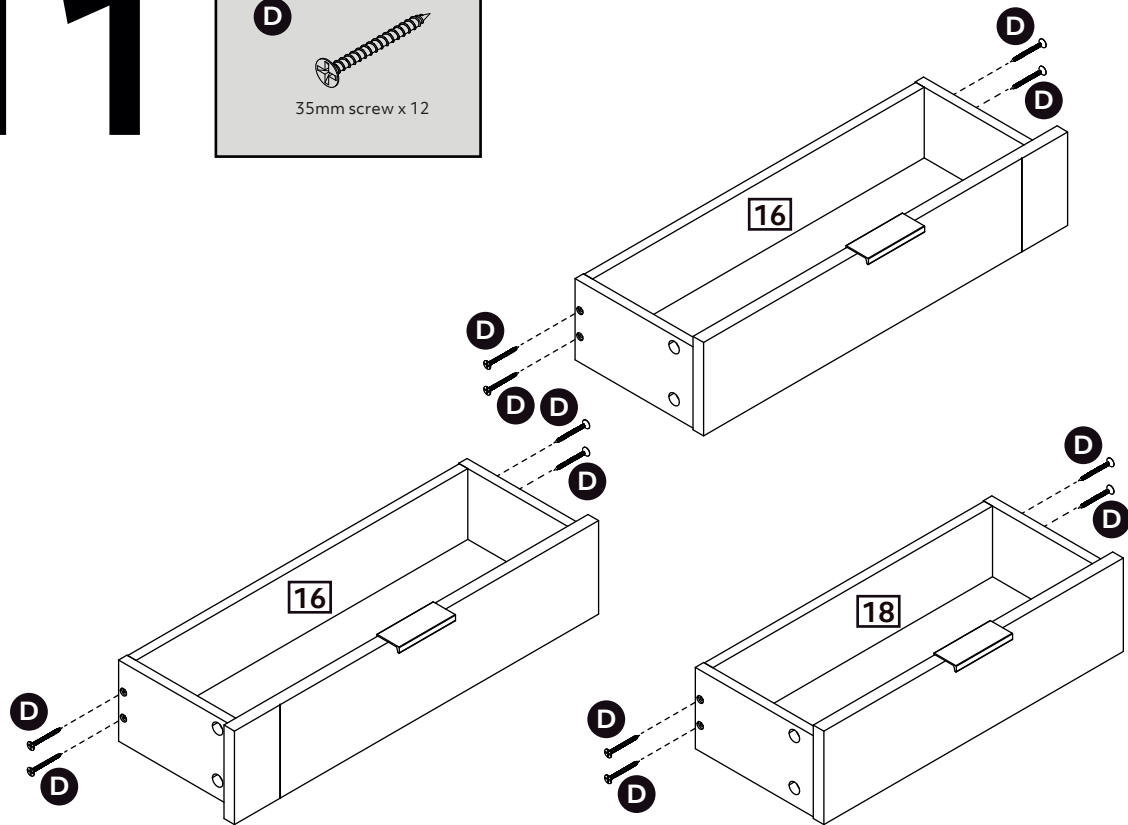

12

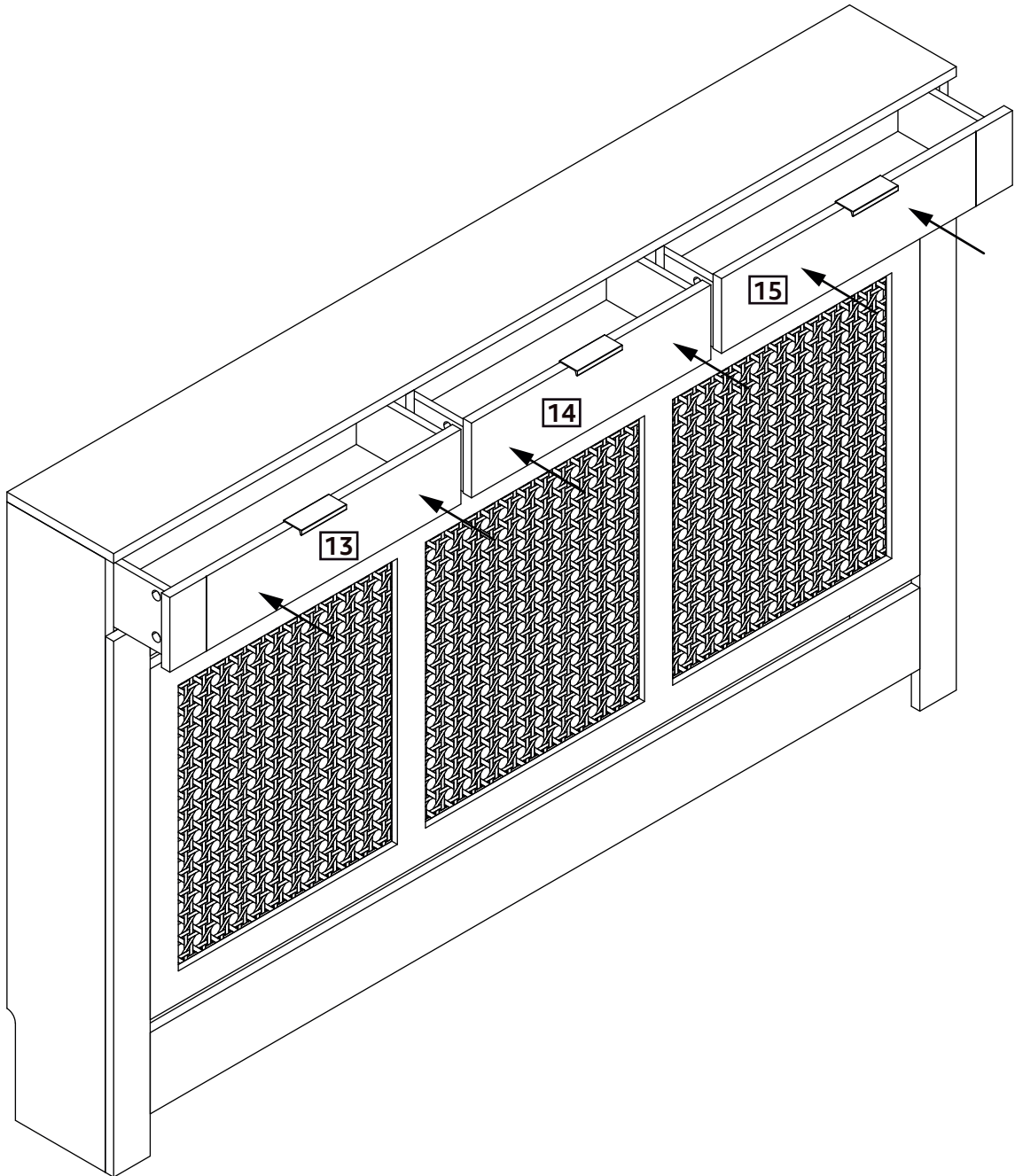

13

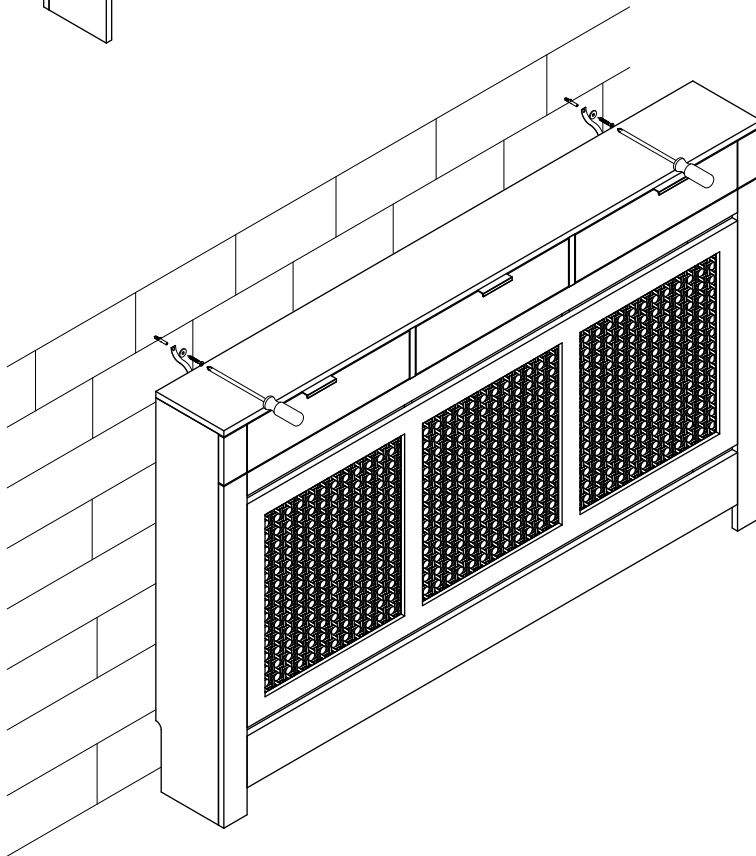
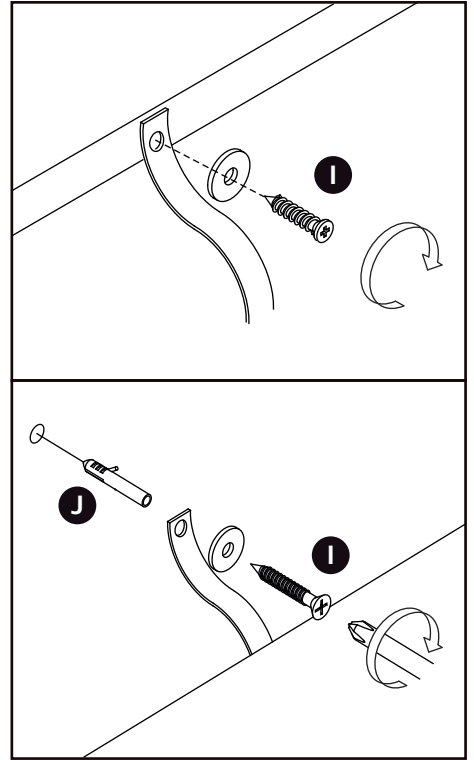
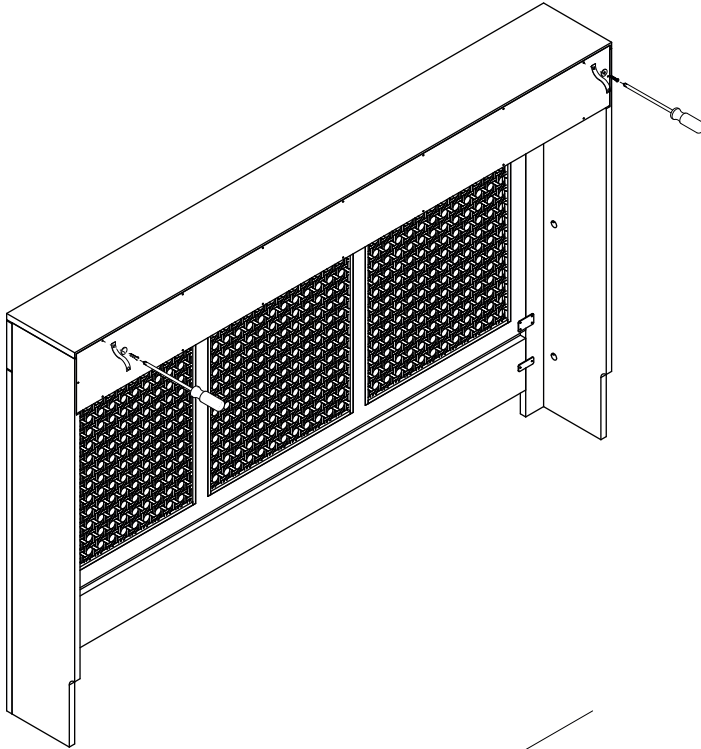
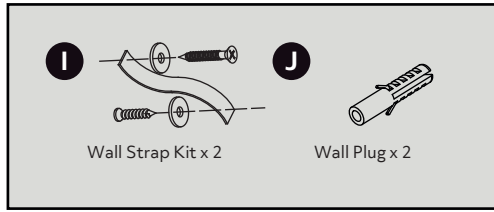

Using camlocks

Step 1

Connect the male camlock as directed in the assembly instructions using a screwdriver.

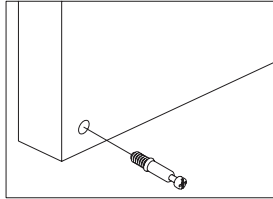

Step 2

Insert the female camlock as shown in the instructions.

Note: Ensure that the arrow on the top of the camlock points towards the entry hole for the male camlock.

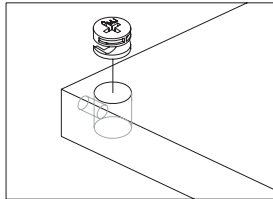

Step 3

Push the male camlock into every hole.

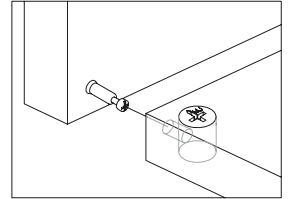

Step 4

Turn the female camlock with a screwdriver.

You should feel a click when the camlock is locked in place.

The joint is now secure.

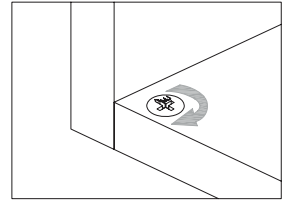

For how to use camlocks watch our video:

www.youtube.com/watch?v=tBMdYxtpu88

A Guide to Wall Mounting & Fixings

Important note:

If plastic wall plugs (rawl plugs) are supplied with your product, eg:



- these are suitable for use in masonry walls

If you are in any doubt about the correct wall plugs for your wall, seek professional advice.

Failure of the product due to using the incorrect fixings is the responsibility of the installer.



Important: when drilling into walls always check that there are no hidden wires or pipes etc.



Hints:

1. General rule: always use a larger screw and wall plug if you are not sure.
2. Ensure you use the recommended drill bit to match the wall plug and hole size.
3. Ensure you drill the hole horizontally; do not force the drill or enlarge the hole.
4. Take extra care when drilling high walls, ceilings and ceramic tiles. Ensure wall plugs are inserted beyond the thickness of the ceramic tiles to avoid the tiles splitting or cracking.
5. Ensure wall plugs are well fitted and are a tight fit in the drilled hole.

Types of walls

You can use one of the following types of wall plug if your walls are made of brick, breeze block, concrete, stone or wood.

No. 1 "General Purpose" wall plug

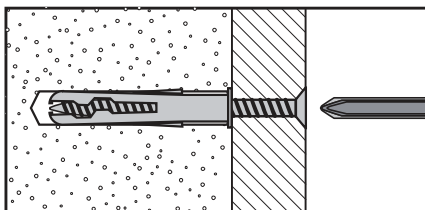

Generally aerated blocks should not be used to support heavy loads, use a specialist fitting in this case. For light loads, general purpose wall plugs can be used.

No. 3 "Cavity Fixing" wall plug

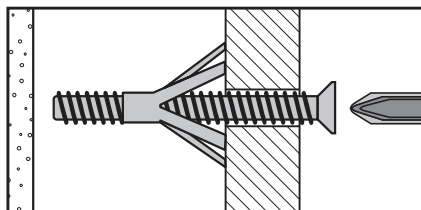

For use with plasterboard partitions or hollow wooden doors.

No. 5 "Hammer Fixing" wall plug

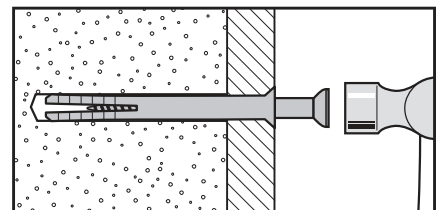

For use with walls stuck with plasterboard. The hammer fixing allows it to be fixed to the wall rather than the plasterboard. Always check the fixing is secure to the retaining wall.

No. 2 "Plasterboard" wall plug

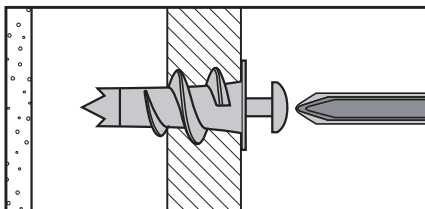

For use when attaching light loads onto plasterboard partitions.

No. 4 "Cavity Fixing - Heavy Duty" wall plug

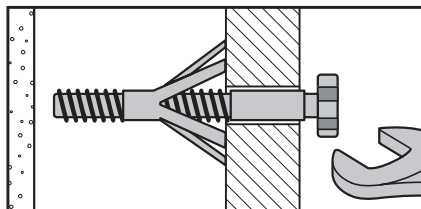

For use when fitting or supporting heavy loads such as shelving, wall cabinets and coat racks.

No. 6 "Shield Anchor" wall plug - heavy loads

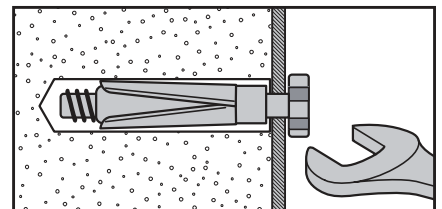

For use with heavier loads such as TV and HiFi speakers and satellite dishes etc.



Care & Maintenance

Safety: Always check the fitting and location to ensure your safety in and around the home.

Fitting: From time to time check the fitting to ensure the wall plugs or screws do not become loose.