

# **INSTRUCTION MANUAL RADIATING PANEL**

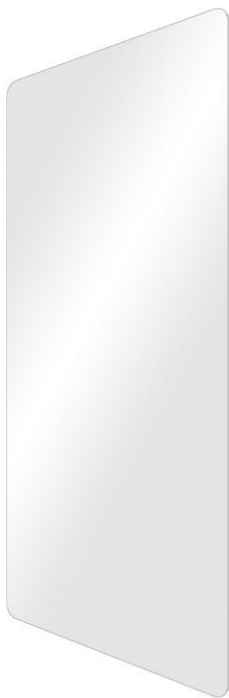

## This appliance complies with European Directives:



2004/108/EC on electromagnetic compatibility.  
2006/95/EC on low voltage.  
2002/95/EC on the restrictions of the use of certain hazardous substances.

### 1. Technical features of the appliance

230V 50Hz

Class II 

Degree of protection: IP24

The features of the appliance are indicated on the features label situated on the rear edge of the cover.

**XXXX**

**XXXXX XX**  
**12345678**

Cat.

**TYPE....**

Model.....

**IP24 230V~50Hz**

**....W**



**XXXX :** Manufacturer's trademark or brand

**12345678:** serial No.

Category:.....- type:.....- model.....

Degree of protection:.....-Voltage:..... - Power.....

**EC Marking – double insulation – quality label**

## 2 . General Information

**Unpack the appliance and place it either on the polystyrene protection or on a carpet**

**Package content:**

**Appliance**



**Remote control**



**Wall mounting kit**

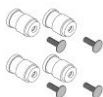

**Instruction manual**

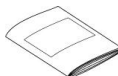

- Read these instructions carefully before installing and using the appliance. Keep them for all future reference.
- Use the appliance only according to these instructions.
- These instructions, however, do not cover all situations that may arise. Use caution and common sense when installing and using the appliance.
- It is forbidden to modify in any way the features of the appliance or to disconnect fixed parts.
- Make sure that the appliance is in good state.
- Do not use the appliance if damaged.  
Contact the retailer or professional qualified personnel.
- The materials used for packaging can be recycled. For disposal use the dedicated recycling containers.

### 3. Positioning and installation

This appliance is intended for domestic use for room heating. It shall not be put to any other use.

It must be fixed onto a wall as indicated in this instruction manual.

In case of vertical positioning the control graphics must be kept on the right-hand side, while for horizontal positioning the control graphics must be kept on the lower side.

In the bathroom or shower the appliance must be fitted outside the safety zone.

The control devices must be out of reach for people in the bathroom or shower.

The controls must be placed in zone 3.

(Fig. 1)

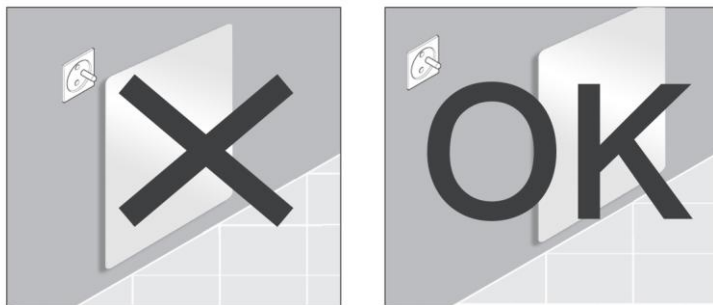

Fig 4

Keep the given minimum distances.

( fig. 2 – 3)

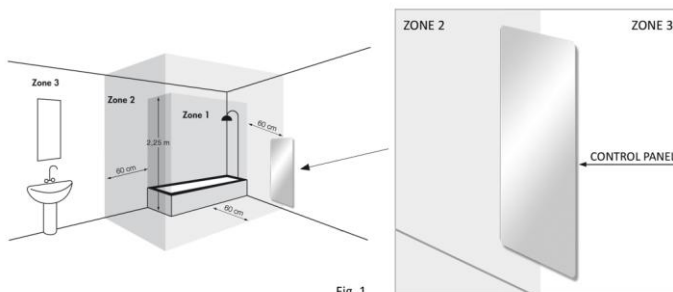

Fig. 1

**Do not install the appliance:**

- Right below a power socket

**(Fig.4)**

- In contact with the wall or floor.
- In close proximity to flammable or combustible materials or pressurized containers.
- Make sure that there are no electrical cables or pipes in the wall which could be damaged during installation.

### 3.1 Wall mounting

Make sure the plugs and screws provided are suitable for the wall type onto which the appliance is going to be mounted.

If in doubt, ask professional qualified personnel.

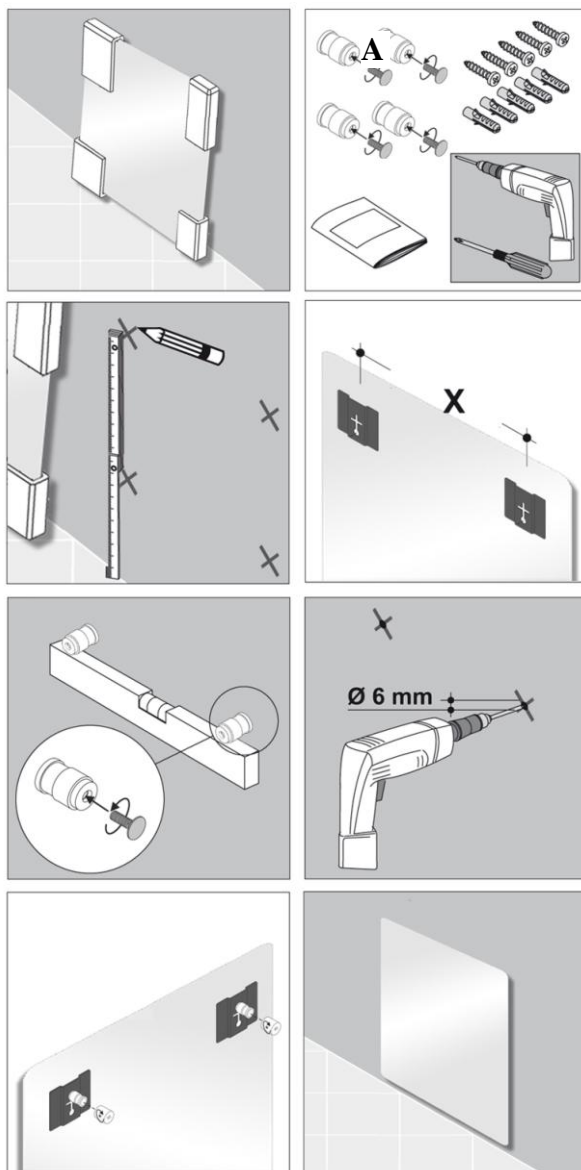

## **IMPORTANT**

It is recommended to secure the appliance only with the A screws on the upper shelves. Leave the lower screws slightly loosened so as to allow the expansion of the panel when heating".

**It is advisable to contact a qualified technician.**

The electrical connection must be carried out in compliance with the national regulations for electricians in force.

Before connecting the appliance to the electrical network, make sure that the power is off, and that the general switch is in the "O" (off) position.

**Do not install the appliance if:**

- The power supply cable is damaged.
- The appliance and the control boxes are damaged.
- The appliance supply voltage is 230V 50Hz.  
Make sure the power line complies with the appliance's voltage.
- Make sure that the power supply cable never comes into contact with the hot surface of the appliance.

The power line must be equipped with an omnipolar cut-off device with a gap between contacts of at least 3 mm, including the pilot-wire if present.

If the appliance is mounted in the bathroom or shower, the power line, including the pilot-wire, must be equipped with a high-sensitivity differential protection with maximum rated current of 30mA.

In humid environments (bathrooms, kitchens, laundry rooms etc.) it is very important that the electrical connection to the network is situated at least at 25 cm from the floor.

Strictly observe the connection diagram (**Fig. 5**)

Diagram for France with **Fil Pilote**

Diagram for other countries - 2 wires

**IMPORTANT: For France only:**

If the pilot-wire is not connected to a programming device it must be isolated.

**The pilot-wire must never be connected to a ground terminal.**

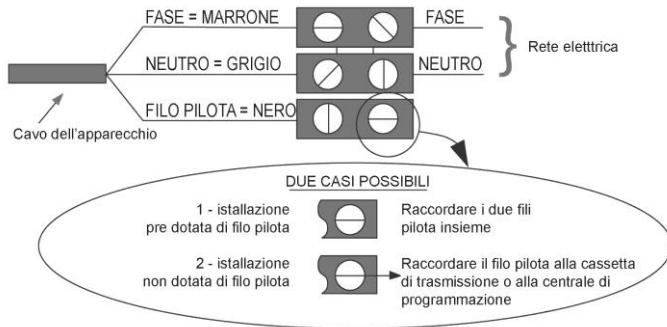

Fig. 5

#### 4. Warnings

- This appliance is not intended for use by persons (including children) with reduced physical sensory or mental capabilities.
- Children under 3 years of age must be kept away from the appliance and always be supervised.  
The appliance can be used by children aged between 3 and 8 and by people with reduced physical, sensory or mental capabilities, or with lack of experience or necessary knowledge, as long as they are being supervised and/or after they have received appropriate instructions for a safe use of the appliance and for an understanding of its inherent dangers. They shall not disconnect or connect the unit, calibrate it or do cleaning and maintenance.  
Children must not play with the appliance.
- The appliance was designed for the heating of domestic premises.
- During normal operation the surface of the appliance may reach high temperatures which can cause burns.
- Combustible or flammable materials and pressurized containers (sprays, fire extinguishers, etc.) must be kept at a distance of at least 50cm from the appliance.
- Do not touch the appliance with wet hands or feet.
- The appliance must not be used if the crystal glass is damaged.
- It is important not to cover the appliance at any time in order to avoid dangerous overheating. **(Fig. 6)**



Fig 6





## 4.1. Control panel (touch screen)

Control panel with symbols and functions (Fig. 7)

<b>T1</b>	STAND-BY.....	<b>L1</b>
<b>T2</b>	Low-temperature heating (50°C) .....	<b>L2</b>
<b>T3</b>	Medium-temperature heating (70°C) .....	<b>L3</b>
<b>T4</b>	Maximum-temperature heating (90°C) .....	<b>L4</b>
<b>T5</b>	Maximum-temperature 2-hours boost .....	<b>L5</b>
<b>T6</b>	Keypad Lock.....	<b>L6</b>
<b>L7</b>	Red LED indicates radiator is heating up	
<b>L8</b>	Appliance in tension	
<b>S1</b>	Infrared sensor for remote control	

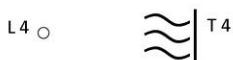
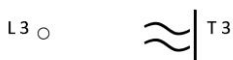
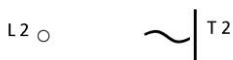

Fig 7

The Eyebeam radiators are equipped with an advanced control system with touch-screen controls and light indicators which indicate the set function.

Changes in settings are also remarked by an acoustic signal.

- When connecting the power supply, all the LEDs light up for 2 seconds and you will hear a long “beep”. After this, only L1 and L8 will remain on.
- Touch T2 if you wish to heat up the room at low temperature. The L2 and L7 green LEDs will light up and you will hear a “beep”. When the surface of the radiator reaches the set temperature, L7 switches on and off cyclically in order to maintain the set temperature.
- Touch T3 if you wish to heat up the room at medium temperature. The L3 and L7 green LEDs will light up and you will hear a “beep”. When the surface of the radiator reaches the set temperature, L7 switches on and off cyclically in order to maintain the set temperature.
- Touch T4 if you wish to heat up the room at maximum temperature. The L4 and L7 green LED will light up and you will hear a “beep”. When the surface of the radiator reaches the set temperature, L7 switches on and off cyclically in order to maintain the desired temperature.
  
- Touch the T5 button if you wish to have the maximum surface temperature for a limited time (2 hours), the L5 and L7 LEDs will light up. The radiator will operate at maximum temperature for 2 hours, after which, it will go back to operate in the function set before the Boost function.
  
- If after the settings you wish to lock the keypad, press the T6 button for 5 seconds - you will hear 4 beeps confirming the setting. When touching the other buttons lightly, the L6 LED will flash for 2-3 seconds indicating the keypad is currently locked.

Only the T1 button will remain operational, so to put the appliance on stand-by at any time.

To reactivate the keypad, press the T6 button for 5 seconds - 4 consecutive beeps will confirm the setting.

## **5. REMOTE CONTROL**

The Eyebeam radiators are equipped with infrared remote control, allowing to communicate room temperature control to the S1 sensor and to set different operating programs.

When the S1 sensor receives the information the L8 LED flashes to indicate the reception of communication, it will then stay lit to indicate that the device has been programmed.

For good communication, point the remote control towards the receiver unit of the appliance.

The distance between remote control and receiver must not exceed 7 m.

### **5.1 INSERTING AND REPLACING BATTERIES**

- Remove the lid situated at the rear of the remote control.
- Insert two 1.5 V - AAA alkaline batteries in the right position paying attention to + and – polarity.
- Place the lid back into position.
- Both in case of replacement of the batteries and of disposal of the remote control, batteries must be removed and disposed of in compliance with applicable laws, as they are harmful for the environment.

## 5.2 General Description

- 1 : Double infrared communication, one at the top and one at the bottom of the remote control
- 2 : Seven push-buttons
- 3 : Maximum communication distance from device: 7 m
- 4 : Two - AAA - LR03 - 1.5 V batteries

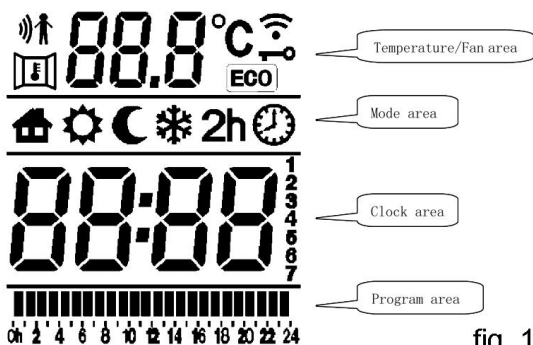
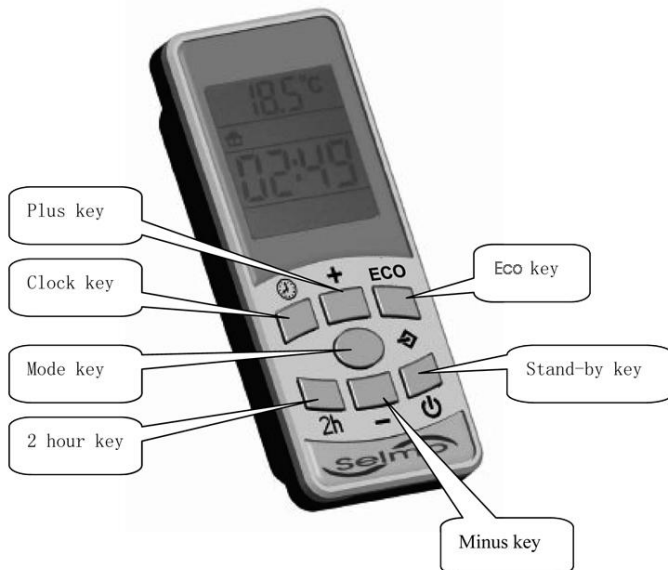











fig. 1

<b>Symbol</b>	<b>Mode</b>	<b>Function description</b>
	<b>Comfort</b>	The temperature of the appliance is controlled by the “Comfort mode” settings
	<b>Night</b>	The temperature of the appliance is controlled by the “Night mode” settings
	<b>Anti-freeze</b>	The temperature of the appliance is controlled by the “Anti-freeze” settings
	<b>Pilot-wire</b>	The temperature of the appliance is controlled by the pilot-wire
	<b>Clock</b>	The temperature of the appliance is controlled by the mode of either the “comfort” or “night” programs
<b>2h</b>	<b>2-h timer</b>	The appliance heats up the room at maximum power
	<b>Lock</b>	Locks the keypad of the appliance
<b>ECO</b>	<b>Eco</b>	The keys of the appliance are locked
	<b>Window open</b>	The appliance activates the “Window open” function
	<b>Radar</b>	The appliance activates the “radar” function
	<b>Stand-by</b>	The appliance is not in operation

## Switching Modes

See Fig.1 below :

1 : Once the batteries are installed, the LCD display will be showing all symbols for 3 seconds.

After this, go to the “Date and time settings” interface – the date will be flashing, the user will then be able to set the date by using the “Plus” or “Minus” buttons.

Press then the “Mode” button - the “Hour” will be flashing – set current hour by using the “Plus” or “Minus” buttons.

Then press the “Mode” button once again – the minutes section will be flashing – set current minute by using the “Plus” or “Minus” buttons once again.

Press the “Mode” button again to terminate the Minutes setting and to switch to stand-by mode.

While “Date” is flashing, if the user does not wish to set any parameter, just press the "Stand-by" button to switch to stand-by mode immediately.

Fig. 1

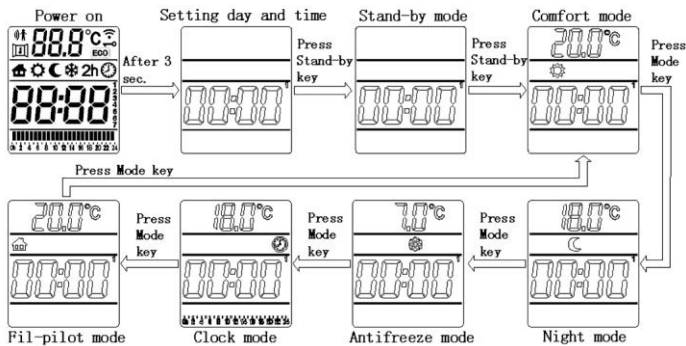

fig.1

2 : once date/hour/minutes are set and once having switched to “stand-by” mode, press the “Stand-by” button - the remote control will switch to “Comfort” mode.

From the "Comfort" mode, by pressing the “Mode” button, the “Night” mode will be activated.

Similarly, by pressing the “Mode” button again, the remote control's modes will switch to: Comfort Mode – Night Mode – Antifreeze Mode – Clock Mode – Pilot-Wire Mode – Comfort Mode\*\*\*

### Comfort and Night Modes – setting of the mode's temperature (see Fig.1 )

1 : Go to “Night” or “Comfort” mode - use “Plus” or “Minus” buttons for temperature setting: by pressing the “Plus” button once, the temperature will rise by 0.5 degrees, by pressing the “Minus” button once, the temperature will drop by 0.5 degrees.

Temperature can be adjusted from 7 up to 32 degrees.

2 : The “Night” mode temperature setting can not be higher than the “Comfort” mode’s one.

*Example : If the “Comfort” mode’s temperature has been set to 25 degrees, when switching to “Night” mode and wanting to set the temperature, once it reaches 25 degrees, the temperature will not rise, even when pressing the “Plus” button.*

### **Antifreeze Mode ( see Fig.1 )**

Go to “Antifreeze” mode, the temperature is fixed to 7 degrees, by pressing the “Plus” or “Minus” buttons, the temperature cannot be neither risen nor reduced.

### **Clock Mode ( see Fig.1 )**

Go to “Clock” mode, the LCD display will be showing temperature, date, time and state of the daily program.

### **Pilot-Wire Mode ( see Fig.1 )**

Go to “Pilot-Wire” mode – the device will recognise the commands received from the Pilot-Wire (Comfort / Nigh / Antifreeze / ECO / Stand-by)

### **2-Hours Mode**

In any mode, by pressing the “two hours” button, the device will start to heat up the environment at full power for 2 hours.

By pressing the button again, the remote control will go back to the previous mode. (Fig 2)

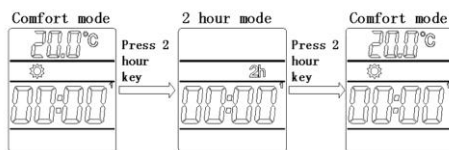

fig 2

### **Stand-by Mode**

In any mode, by pressing the "Stand-by" button, the remote control will go into stand-by mode and the device will stop operating.

By pressing this button again, the remote control will go back to the previous mode. (Fig 3)

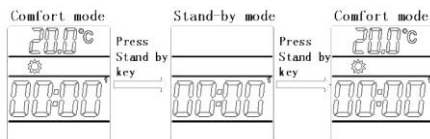

fig. 3

## **Eco Mode**

Eco mode can be activated to reduce power consumption when the room is empty for a specific period of time. By pressing the "Eco" button, the remote control display will show the icon of the function.

By pressing the "Eco" button again, the function will be disabled and the icon will disappear.

## **“Window open” Mode**

Pressing the "Eco" and "-" buttons simultaneously for 3 seconds will activate the 'window open' sensor. Pressing the "Eco" and "-" buttons again simultaneously for 3 seconds will disable the function.

## **“Presence” Radar Mode**

Pressing the "Eco" and "+" buttons simultaneously for 3 seconds will activate the sensor of presence in the room. Pressing the button "Eco" and "+" buttons again simultaneously for 3 seconds will disable the function.

## **Time and program setting**

1 : In any mode, by pressing the “Date” button, the date will start flashing – the user will then be able to set the current date by using the "Plus" or "Minus" buttons. The daily program will also be displayed.

By pressing the "Mode" button, the hour section will start flashing and the user will be able to set the current hour by using the "Plus" or "Minus" buttons.

By pressing the "Mode" button again, the minutes section will start flashing and the user will be able to set the minutes by using the "Plus" or "Minus" buttons.

2 : When the Minutes section is flashing, by pressing the “Mode” button, the user may proceed to set the Monday program and the “0 time” point will start flashing. The user may then use the “Plus” or “Minus” buttons to set the “Comfort temperature” or “Night temperature” to current time (by pressing “Plus” the point indicating that at the current time the “Comfort temperature” mode will be activated. While by pressing the "Minus" button, the point will disappear to indicate that at current time the “Night temperature” mode will be activated. Subsequently, the point of the following hour will flash in the same way for the setting.

By pressing the “Mode” button again, the subsequent day will be displayed and the user will be able to set, in the same way, the modes for the hours from 0 to 23.

**(Fig. 6)**



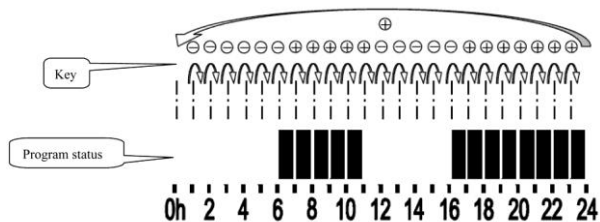

fig. 6

## Keypad Lock

By pressing the “Mode” and “Minus” buttons simultaneously for 3 seconds, the block symbol will be displayed and all buttons will be locked. Thus, at the pressing of any buttons the remote control will not respond.

By pressing once again the “Mode” and “Minus” buttons simultaneously for 3 seconds, the block symbol will disappear and the buttons will go back to being operational. (Fig.7)

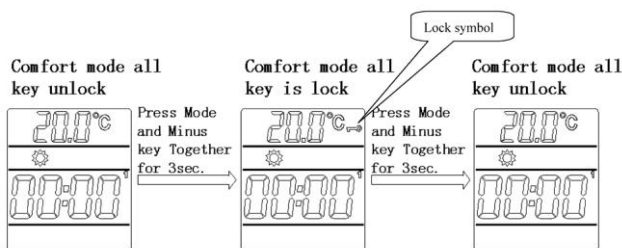

fig.7

## IR transmission

If no button is in operation, after 1 second, the remote control will transmit the IR data to the device and the IR transmission symbol will start flashing. At the end of data transmission the symbol will disappear. (Fig 8)

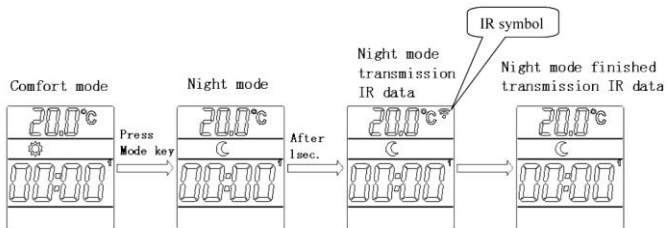

fig.8

## Low Batteries

When the batteries' tension is lower than 2.2 V, the “Battery symbol will be displayed for 3 seconds every minute in the clock zone. The user will have to

replace the batteries. (Fig.9)

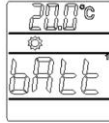

fig.9

## 6. Cleaning and maintenance

Before starting any operation make sure that the equipment is completely cold and that it is disconnected from the mains.

To clean, use a soft damp cloth with mild detergent to clean the crystals. Do not use abrasive cleaners, or corrosive solvents.

In case of technical problems, contact a qualified professional.