

# INSTRUCTION MANUAL

## Electric Wall Mounted Fire

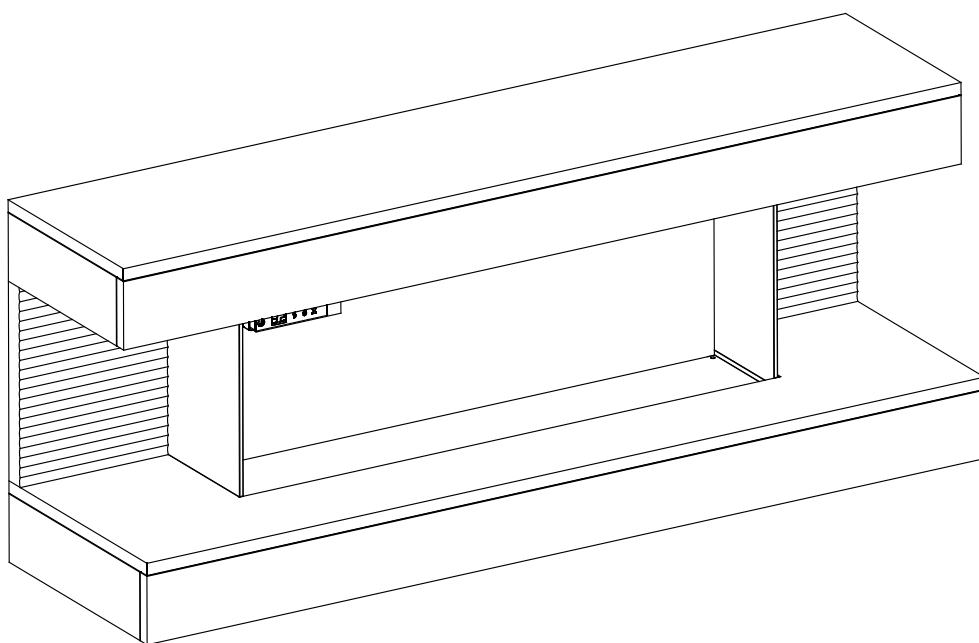

**This product is only suitable for well insulated spaces or occasional use.**

### **IMPORTANT**

The fan will run for approximately 30 seconds after the heater is turned off. This is to remove any residual heat from the fire to prevent any potential overheating.

[www.firedupcorporation.com/manual](http://www.firedupcorporation.com/manual)

# Read ALL the instructions before use.

These instructions are for your safety. Please read through them thoroughly before use and retain for future reference. Failure to follow them could cause injury and/or property damage.

---

## CONTENTS

### SECTION 01

Cautions	03-06
Introduction	07
Handling	07

### SECTION 02

Unpacking & Care	07
Fitting the trim	07
Installing the fire	08-09
Fuel bed	10
Remote control & Control panel	11

### SECTION 03

Operation	12-15
Reset settings & Additional features	16
Plug replacement	16
Technical parameters	17
Specification, Conformity & Environment	18
Guarantee & Contacts	20

## CAUTIONS

### DO'S

---

- Read ALL the instructions before using this product.

---

- Only use this product for its intended use as described in this manual.

---

- Always use the product in accordance with this guide. If in doubt obtain expert advice.

---

- Always check your mains supply is the same as that indicated on the product before connecting.

---

- Always make sure the electrical socket is accessible.

---

- Always disconnect the heater from the electrical supply before carrying out cleaning or maintenance. To disconnect the heater, switch controls to OFF then remove plug from the outlet.

---

- Ensure the floor space is flat and even.

---

### DON'TS

---

- Never leave children unsupervised in a room where the fire is ON and unguarded.

---

- Never obstruct or cover the fan outlet or force items into fire openings.

---

- Never use the product anywhere where water is in use, i.e. bathrooms, ktchens, shower rooms, and swimming pool etc.

- Never use aerosols or steam cleaners on or around the fire.
- 
- Never route the supply cord under carpeting and never cover the cord with throw rugs, runners, etc. Arrange the cord away from traffic areas and where it will not be tripped over.
- 
- Never place the heater close to curtains or combustible materials. Keep furniture, bedding, papers, clothes, curtains, etc. at least 1m away from the front of the heater and keep away from the sides and rear.
- 
- Never use the product to dry clothes etc.
- 
- Never sit or stand on the product.
- 
- Never lean or put weight on the product.
- 
- Do not use outdoors.
- 
- Do not sit the product on deep pile carpets or rugs.
- 

Avoid the use of an extension cord which may overheat and cause risk of fire. If an extension cord is necessary, it must be rated above the maximum rated power of the appliance. Care must be taken to arrange the cord so that it cannot be pulled or be tripped over.

## IMPORTANT!

- This appliance can be used by children aged from 8 years and above and persons with reduced physical, sensory or mental capabilities or lack of experience and knowledge if they have been given supervision or instruction concerning use of the appliance in a safe way and understand the hazards involved.
- Children shall not play with the appliance.
- Cleaning and user maintenance shall not be made by children without supervision.
- If the supply cord is damaged, it must be replaced by the manufacturer, its service agent or similarly qualified persons in order to avoid a hazard.



**WARNING:** In order to avoid overheating,  
**DO NOT COVER THE HEATER**

- The heater must not be located immediately below a socket outlet.
- Children of less than 3 years should be kept away unless continuously supervised.
- Please note the LED bulb in the appliance is non replaceable, do not attempt to replace it.
- Children aged from 3 years and less than 8 years shall only switch on/off the appliance provided that it has been placed or installed in its intended normal operating position and they have been given supervision or instruction concerning use of the appliance in a safe way and understand the hazards involved. Children aged from 3 years and less than 8 years shall not plug in, regulate and clean the appliance or perform user maintenance.

- CAUTION — Some parts of this product can become very hot and cause burns. Particular attention has to be given where children and vulnerable people are present.
- This heater is hot when in use. To avoid burns, do not touch hot surfaces such as surfaces around the grille in front of the heater. Never let bare skin touch hot surfaces.
- Do not use this heater in the immediate surroundings of a bath, a shower or a swimming pool.

**Note:** When the heater is turned on for the first time or when it has not been used for some time, it may release a slight, harmless odour. This odour is a normal occurrence caused by the initial heating of the internal heating elements and will disappear with use.

**Note:** The fan will run for approximately 30 seconds after the heater is turned off. This is to remove any residual heat from the fire to prevent any potential overheating.

## INTRODUCTION

Thank you for choosing this product. It is designed to meet the most stringent quality, performance, and safety requirements. This guide aims to improve your understanding and appreciation of your new product by providing simple and informative instructions.

## HANDLING

Before continuing any further with the installation of this product please read the following:

- When lifting always keep your back straight. Bend your legs and not your back.
- Avoid twisting at the waist. It is better to reposition your feet.
- Avoid upper body / top heavy bending. Always bend from the knees rather than the waist.
- Do not lean forward or sideways whilst handling the product.
- Always grip with the palm of the hand. Do not use the tips of fingers for support.
- Always keep the product as close to the body as possible. This will prevent unnecessary and undue strain on the body.
- Use gloves to provide additional grip.
- Always use assistance if required

## UNPACKING

The unit is supplied in a single package carton. Carefully unpack the product using the following procedure:

- Carefully lift the parts out of the box
- Carefully remove the protective wrapping from the parts
- Locate the instruction manual and put aside
- Carefully remove the product from its box and put aside

## CARE

- Brushed stainless steel can be cleaned using a cloth and propriety cleaner.
- Fires with a glass screen can be cleaned using a cloth and propriety cleaner.
- Other features (non-silver) can be cleaned using a damp cloth.
- If the supply cord is damaged, it must be replaced by a suitably qualified person.
- The area around the fire should be kept free from animal hair, lint and other extraneous material that may be drawn into the workings of the appliance which could affect its performance.

## MOUNTING ON TO A WALL

The fire can be mounted to a wall. The following procedure and dimensions are important.

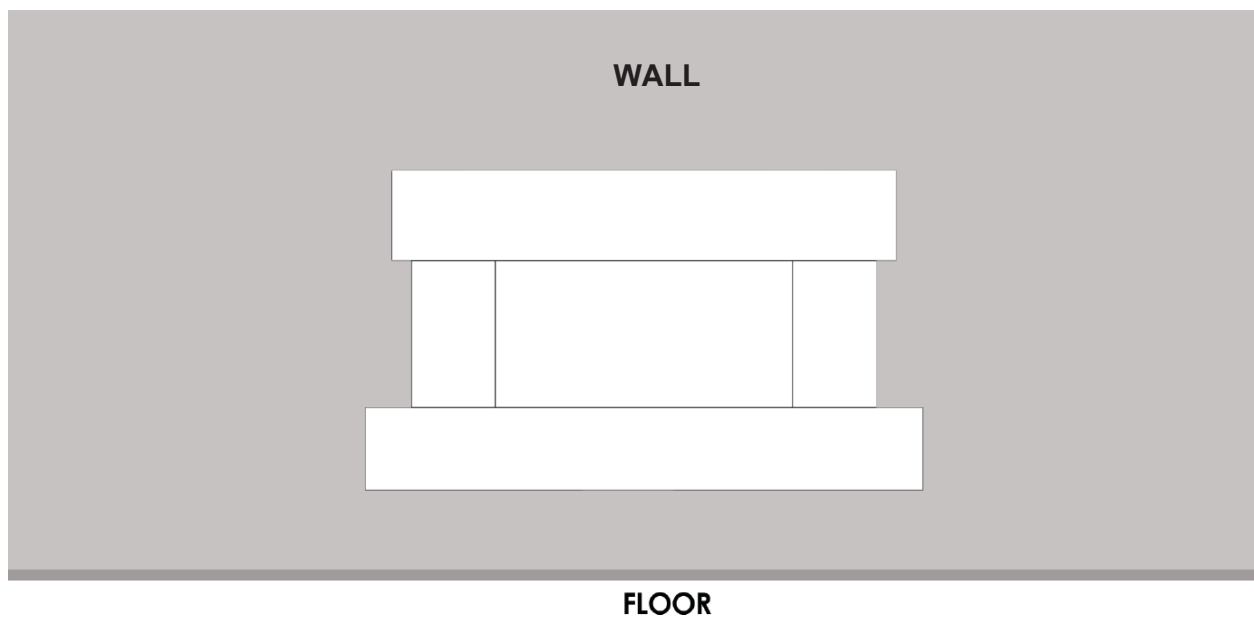

### FIXING KIT

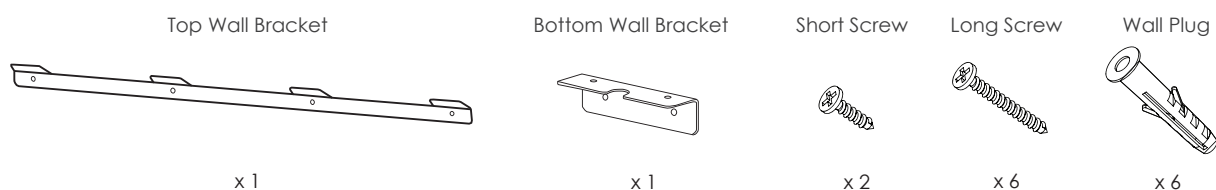

Note: Wall plugs supplied are for a solid wall. If screwing in to plaster board or wood, please use correct fixings.

### TOOLS REQUIRED

- Crosshead Screwdriver
- Pencil
- Drill
- 6mm Drill Bit

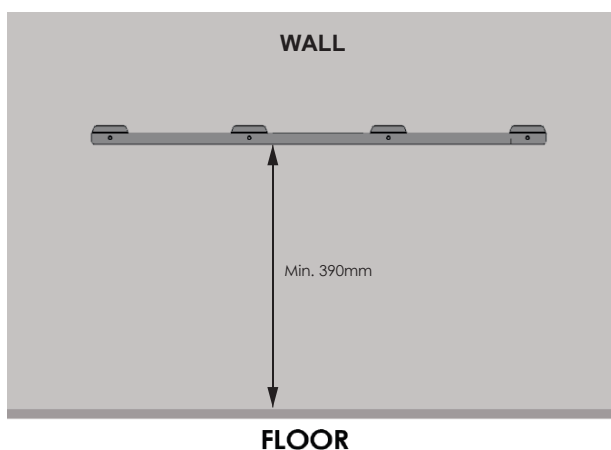

1. Measure min. 390mm from the floor
2. Mark the holes required for top bracket
3. Drill 6mm diameter holes approximately 35mm deep
4. Insert the wall plugs
5. Screw top bracket to the wall



## Cont...

6. Carefully lift fire and align slots with top bracket
7. Slot fire onto top bracket

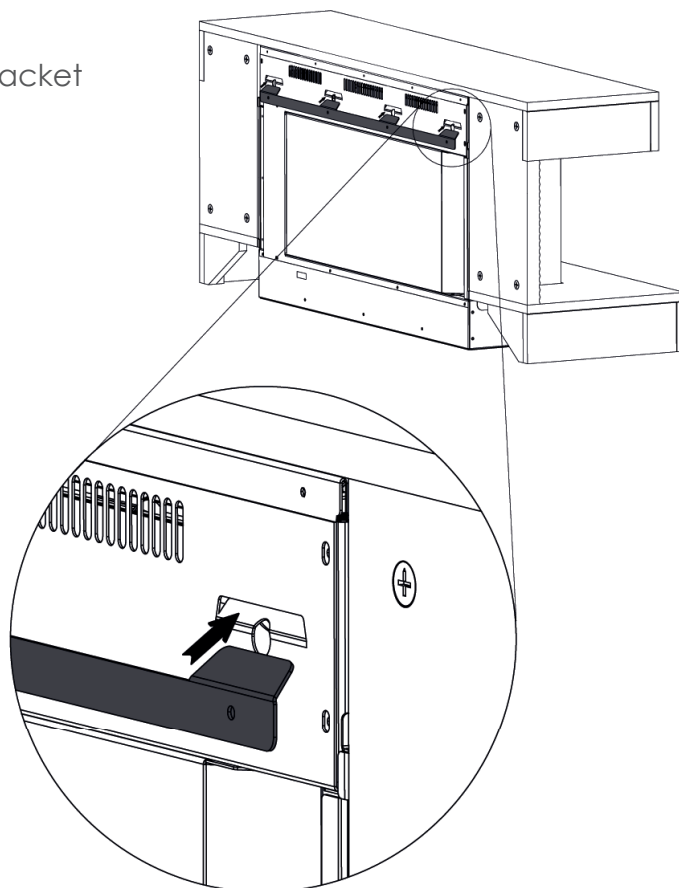

8. Align holes on bottom bracket to bottom of fire and mark the holes required on the wall

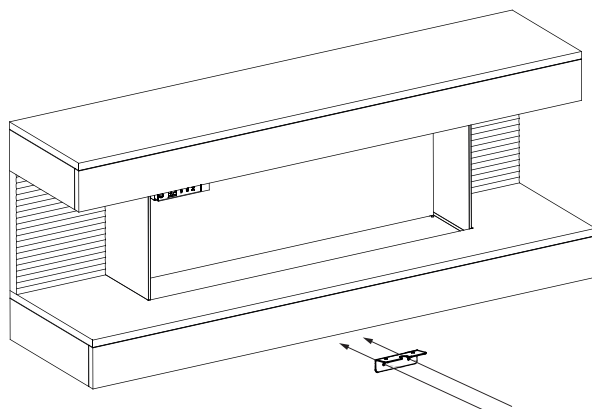

9. Drill 6mm diameter holes approximately 35mm deep

10. Insert the wall plugs

11. Re-align bottom bracket with holes on the wall and bottom of fire

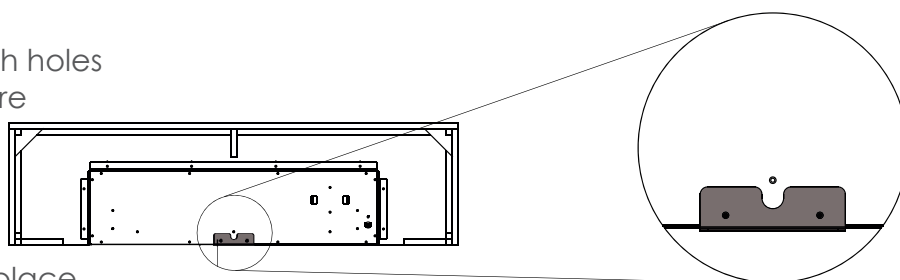

12. Screw bottom bracket into place

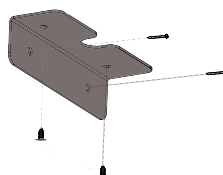

# Fuel Bed

Arrange the fuel bed using the logs and pebbles provided

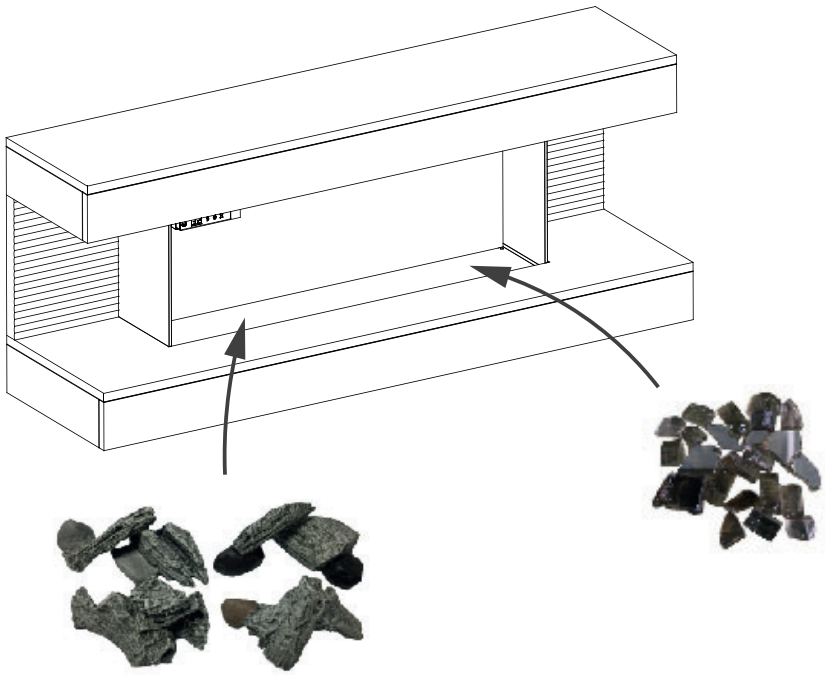

# Remote control

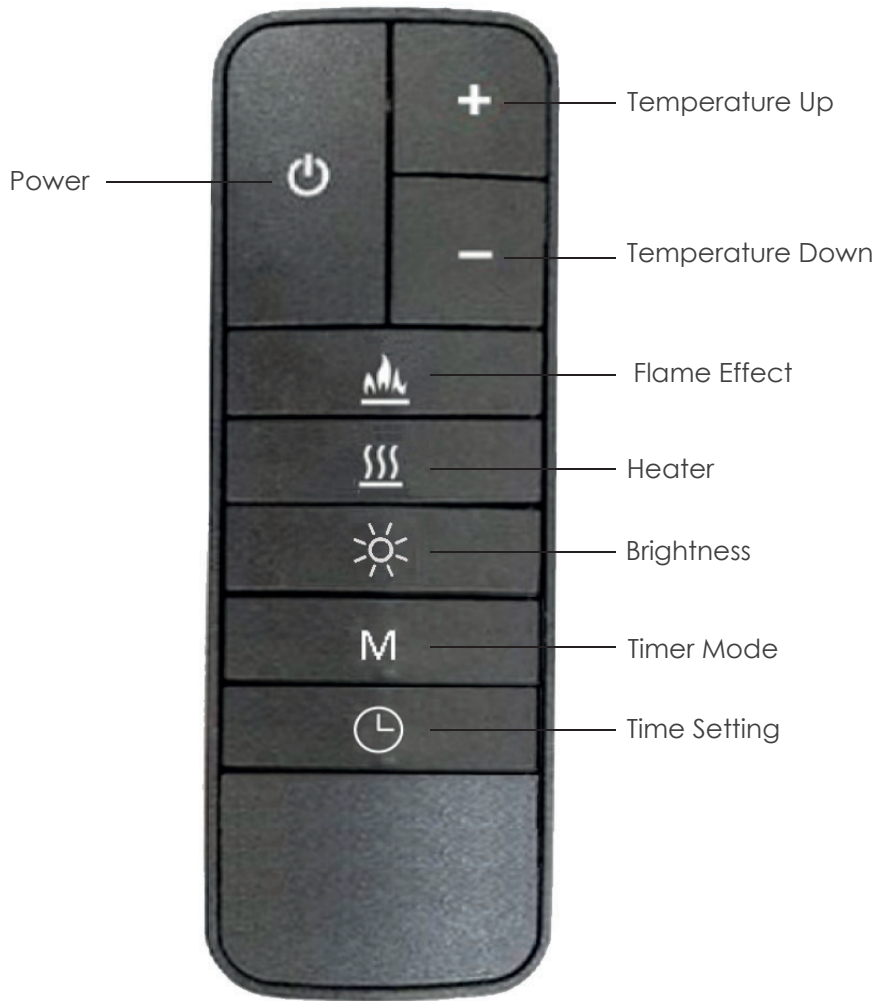

# Control panel

The control panel can be located as shown.

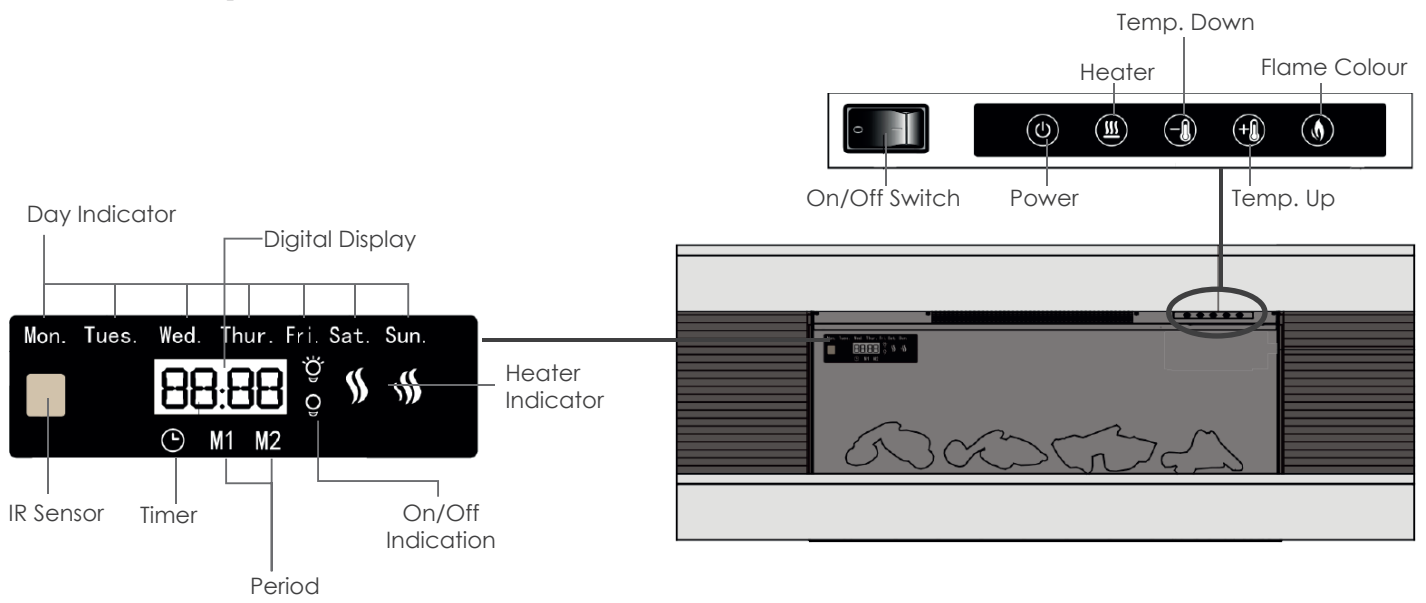

## OPERATION - Manual

On/Off switch must be switched on for the fire to work. The switch is in the ON position when the side with the 'I' marking is 'pressed in'

Brightness setting cannot be changed without the remote control

## OPERATION - Remote control

Insert 2 x AAA batteries to the back of the remote control. Turn the power switch on.

### Powering the fire

Press the power button  to turn the fire on. The room temperature will be displayed and the functions can be used.

Note: This fire has a memory function, the fire will turn on to the last heat setting when the power button  is pressed

### Turn on heater

Pressing the heater button  once will turn the heater onto full, H2 will be shown on the display, along with a red flame symbol.



To select the lower heat setting, press the heater button  again. H1 will be shown on the display, along with an orange flame symbol.



Note: The fan will run for approximately 30 secs. after the heater is turned off to cool the unit down.

### Setting the thermostat (15°- 30°C)

Adjust the desired room temperature using the + and - buttons. The temperature will be shown on the display.

(IF the room temperature is HIGHER than the selected temperature of the fire, the heater will not turn on).



## Flame effect & colour

Eight themes can be selected using the flame effect button , the corresponding theme number will be shown on the display.





1 - OFF  
5 - Blue

2 - Red  
6 - Purple

3 - Sky Blue  
7 - Green

4. Orange  
8. Cycle themes 2-7

Note: Theme 8 cycles through the different colours. Pressing the brightness button  stops the cycle on the selected colour. This is indicated by a solid circle shown on the display. Press the brightness button  again to resume the cycle. The active cycle is indicated by a rotating circle shown on the display.

## Down lights

Holding the flame effect button  for 3 secs. will turn the down lights on/off. 'ON' will be shown on the display when the lights are on.



## Brightness settings

The brightness of the flame can be changed between three settings using the brightness button . The chosen setting will be shown on the display.

H - Highest setting  
C - Medium  
L - Lowest setting

Note: The brightness setting cannot be changed without the remote.



## Set day & time

To show the day and time, press and hold the time setting button  for 2 secs.

Press the time setting button  again to set the DAY. The DAY will flash on the display.

Select the day using the + or - buttons.



Press the time setting button  again and the HOUR will flash.

Select the HOUR using the + or - buttons.



Press the time setting button  again to select MINUTE.

Select the minute using the + or - buttons.

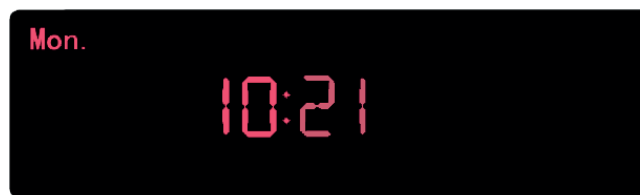



Press the time setting button  to exit the day and time setup.

## Set timers



The timer setting allows for two ON/OFF periods (M1 and M2) to be set for each day of the week.

Press and hold the timer mode button **M** for 2 secs. to begin setting the timer.

The setting for the 1st period ON time  (M1) for Monday will be shown. The HOUR will also flash.

Select the HOUR using the + or - buttons. Press the time setting button  to move to the next step. Use the + or - buttons to change the MINUTE.



Press the time setting button  to set the 1st period OFF time  (M1).

Use the + or - buttons to select the HOUR. Press the time setting button  to move to the next step. Use the + or - buttons to select the MINUTE.



Press the time setting button  to set 2nd period ON time (M2).

Use the + or - buttons to select the HOUR. Press the time setting button  to move to the next step. Use the + or - buttons to select the MINUTE.



Press the time setting button  to set 2nd period OFF time (M2).

Use the + or - buttons to select the HOUR. Press the time setting button  to move to the next step. Use the + or - buttons to select the MINUTE.

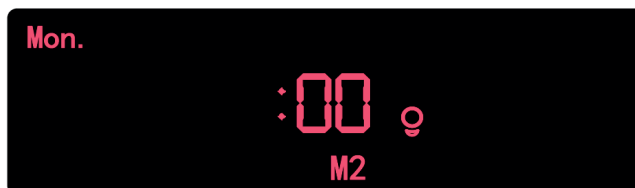

Press the time setting button  to move onto the next day, repeat this process to set the timer for the rest of the week.

Leave the remote for 10 secs. to exit the timer settings.

To activate the timer settings, press the timer mode button **M** until the timer symbol is shown on the display.

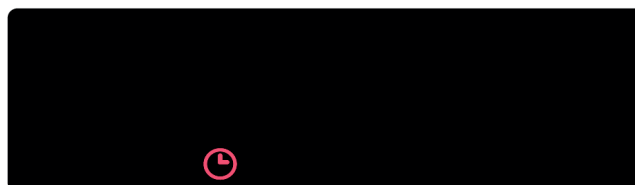

## ADDITIONAL FEATURES

**Open Window/Door Detection** - If the heater is turned on and the ambient room temperature drops, the heater automatically turns off (and ECO is shown on the display). The heater can be turned back on using the heater button .

## PLUG REPLACEMENT

(for products fitted with BS plug)

This appliance is supplied with a BS1363 3 pin plug fitted with a 13 Amp fuse. Should the fuse require replacement, it must be replaced with a fuse rated at **13 Amp** and approved to BS1362.

In the event the mains plug has to be removed/replaced for any reason, please note:

The wires in the mains lead on this appliance are coloured in accordance with the following code:

Green and Yellow - Earth  
 Blue - Neutral  
 Brown - Live

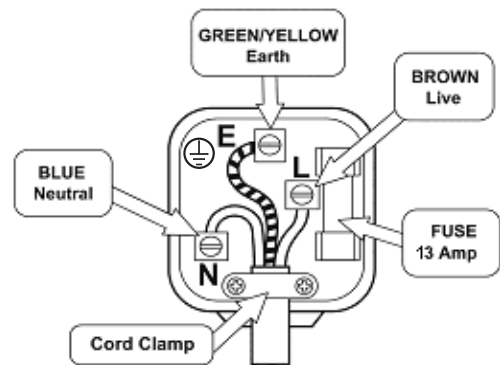

### THIS APPLIANCE MUST BE EARTHED

As the colours may not correspond with the markings identifying the terminals in your plug proceed as follows.

- The green and yellow earth wire must be connected to the terminal in the plug which is marked with the letter E or with the earth symbol 
- The blue wire must be connected to the terminal marked N
- The brown wire must be connected to the terminal marked L

Important - any cut off plug should be disposed of safely to prevent hazard. There is a danger of electric shock if a cut off plug is inserted into a socket outlet.



# TECHNICAL PARAMETERS

## Information requirements for electric local space heaters

Item	Symbol	Value	Unit	Item	Unit
<b>Heat output</b>				<b>Type of heat input, for electric storage local space heaters only (select one)</b>	
Nominal heat output	$P_{nom}$	2.0	kW	manual heat charge control, with integrated thermostat	[yes/no]
Minimum heat output (indicative)	$P_{min}$	1.0	kW	manual heat charge control with room and/or outdoor temperature feedback	[yes/no]
Maximum continuous heat output	$P_{max,c}$	2.0	kW	electronic heat charge control with room and/or outdoor temperature feedback	[yes/no]
<b>Auxiliary electricity consumption</b>				fan assisted heat output	[yes/no]
At nominal heat output	$el_{max}$	N/A	kW	<b>Type of heat output/room temperature control (select one)</b>	
At minimum heat output	$el_{min}$	N/A	kW	single stage heat output and no room temperature control	[yes/no]
In standby mode	$el_{SB}$	0.45	W	Two or more manual stages, no room temperature control	[yes/no]
				with mechanic thermostat room temperature control	[yes/no]
				with electronic room temperature control	[yes/no]
				electronic room temperature control plus day timer	[yes/no]
				electronic room temperature control plus week timer	[yes/no]
				<b>Other control options (multiple selections possible)</b>	
				room temperature control, with presence detection	[yes/no]
				room temperature control, with open window detection	[yes/no]
				with distance control option	[yes/no]
				with adaptive start control	[yes/no]
				with working time limitation	[yes/no]
				with black bulb sensor	[yes/no]
Contact details	Name and address of the manufacturer or its authorised representative. See back page				

The seasonal space heating energy efficiency of all local space heaters except commercial local space heaters  $\eta_S$  (%): 38

## SPECIFICATION

Supply Voltage	-	220-240V~50-60Hz
Rated Power	-	1700-2000W
Fuse Rating	-	13 Amp
Lighting	-	5W LED Array (non serviceable)
Class	-	1

## CONFORMITY WITH DIRECTIVES

Conforms with relevant European Directives

## ENVIRONMENTAL PROTECTION

- (WEEE) Waste Electrical and Electronic Equipment

Waste electrical products should not be disposed of with household waste. Please recycle where facilities exist. Check with your Local Authority or retailer for recycling advice.

- This appliance complies with the RoHS directive which restricts the use of certain hazardous substances in electrical and electronic equipment. This directive bans the placing on the EU market of new electrical and electronic equipment containing more than agreed levels of lead, cadmium, mercury, hexavalent chromium, polybrominated biphenyl (PBB) and polybrominated diphenyl ether (PBDE) flame retardants.





## GUARANTEE

For your convenience, you are not required to complete a form and return it to us in order to validate your guarantee. However, please ensure that you retain your receipt which will act as both proof of purchase and a guarantee validation document. **We recommend that you attach your receipt to this documentation.**

Your product carries a 12 month guarantee from the date that the original purchaser receives it. If your product fails to operate to its specification due to faulty workmanship or materials during the guarantee period, we will either repair or replace the product. We will use our discretion to determine whether to offer a repair or provide a replacement. The product will not be covered by the guarantee if it has been misused, transformed, modified or altered in any way.

If your product fails within the guarantee period please ensure that you have all necessary documentation available including proof of purchase (receipt or invoice with serial number, location and date of purchase) in addition to all original undamaged packaging and leaflets etc. It is strongly recommended that you inspect your product carefully before it is used or installed. For full details of your product you should refer to the instruction manual which accompanies the product. You are strongly advised to read this manual carefully in its entirety and to retain it for future reference.

This product guarantee does not affect your statutory rights.

### CUSTOMER HELPLINE

 03300 882 069

 [customer.support@firedupcorporation.com](mailto:customer.support@firedupcorporation.com)



[www.firedupcorporation.com](http://www.firedupcorporation.com)

Fired Up Corporation Ltd.  
Fired Up Buildings  
St Thomas Road  
Huddersfield  
HD1 3LF  
United Kingdom

---