

Instruction Manual

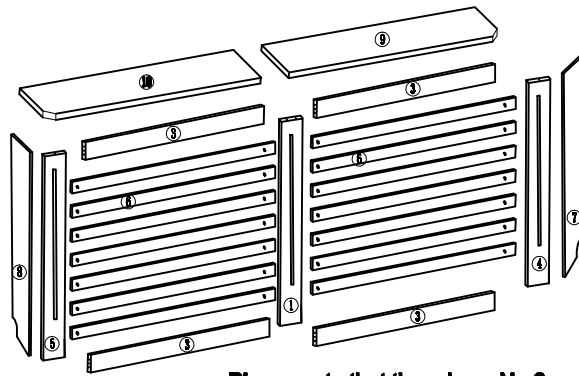

Tools needed

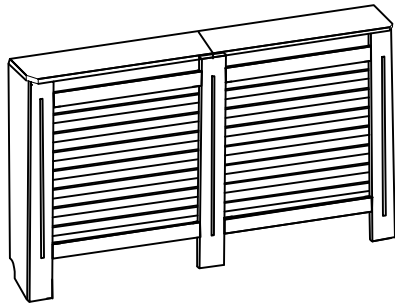
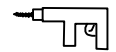

churn drill



hammer

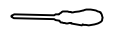

cross screwdriver

Please note that there is no No.2 panel !

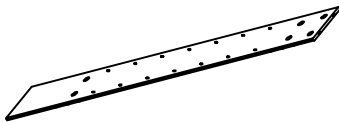

① x1 803*110*12mm

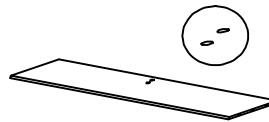

③ x4 581*105*12mm

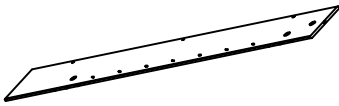

④ x1 803*110*12mm

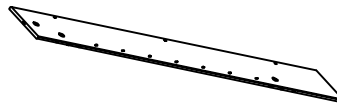

⑤ x1 803*110*12mm

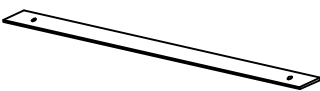

⑥ x14 641*37*9mm

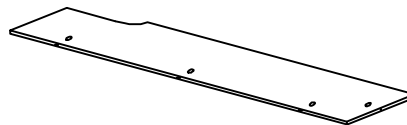

⑦ x1 803*168*12mm

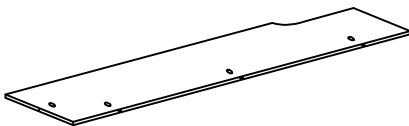

⑧ x1 803*168*12mm

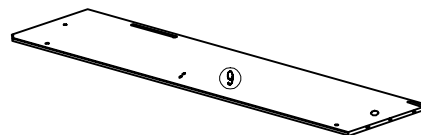

⑨ x1 760*190*12mm

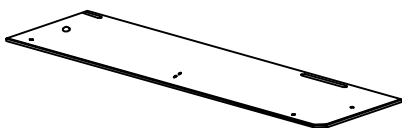

⑩ x1 760*190*12mm



Ax3



Bx20



Cx22

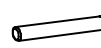

Dx18



Ex28



Fx6



Gx6



Hx2



Ix8



Jx1



Using a screwdriver, screw in the #B screws securely. Please do not over tighten as it may cause wood to splinter. The small arrow on the #C Cam Locking Screw should be facing the #B screws extending from the panel. Use screwdriver to tighten securely, but avoid over tightening, screws may protrude through the panel.

1 2

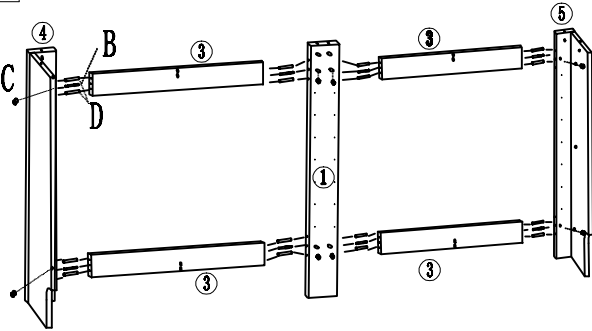
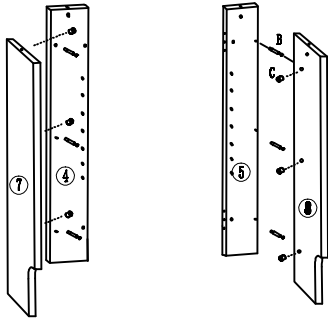

3 4

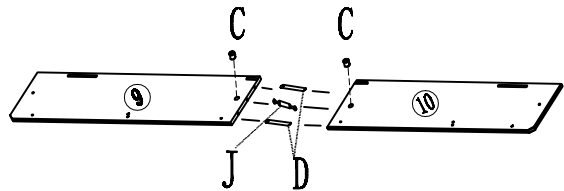
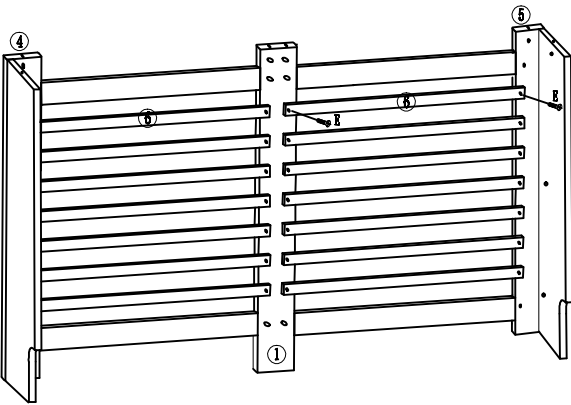

5 6

Keep the panels 9&10 on the same level when moving or the screws may protrude through the panels.

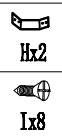
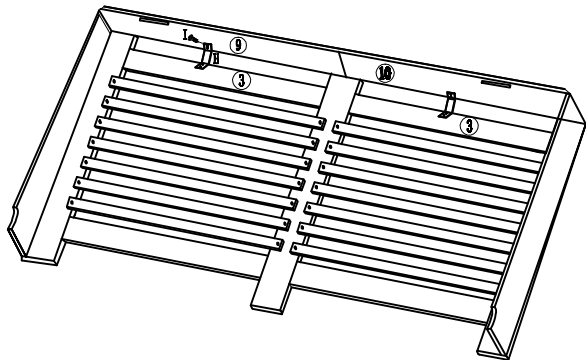
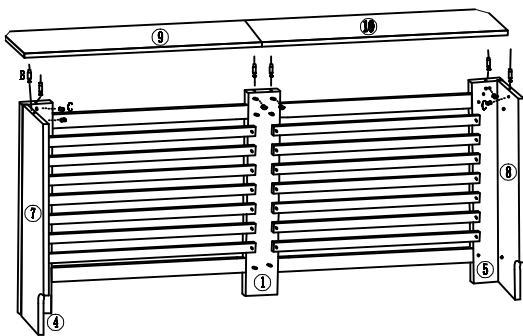

7 8

