

FAUCET HOLE

343mm

WHEN PLOTTING TEMPLATE FULL SIZE:
Make sure horizontal and vertical dimensions
match the dimensions labeled on the template.

KOHLER®

K-20678 TRUE

UNDERMOUNT 1.5 BOWL SINK RH CUT-OUT TEMPLATE / INSTALLATION INSTRUCTIONS

BEFORE YOU BEGIN

WARNING: Risk of personal injury. Metal surfaces are sharp and can cause severe cuts. Use gloves and handle sink edges carefully.

- Observe all local plumbing and building codes.
- Shut off the hot and cold water supplies.
- Prior to installation, unpack the new sink and inspect it for damage. Return the sink to its protective carton until you are ready to install it.
- Inspect the drain and supply tubing. Replace if necessary.
- All information in these instructions is based on the latest product information available at the time of publication. Kohler china reserves the right to make changes at any time without notice.
- This product complies with ISO9001 and 2004/1935/EU.

RECOMMENDED TOOLS AND MATERIALS

- Safety Glasses
- Measuring Tape
- Pencil
- Drill
- Putty Knife
- Silicone Sealant
- Pipe Wrench
- Plumbers Putty

Plus:

- Level
- Cross Screwdriver
- Keyhole/Jigsaw
- Gloves

ROUGHING-IN

Reference Value

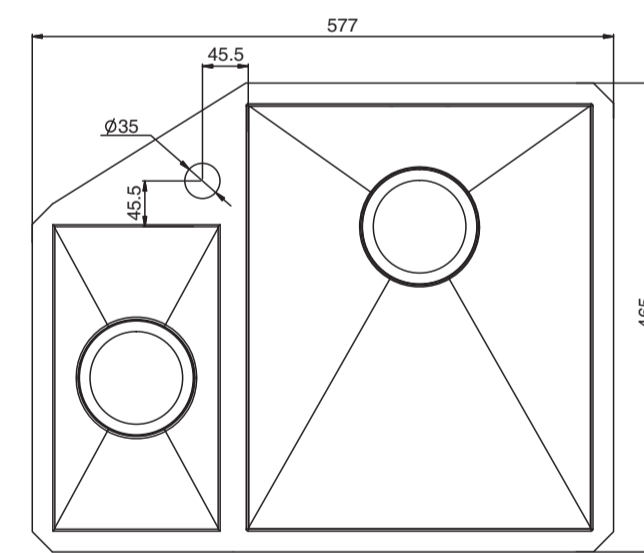

Unit: mm

Kohler reserves the right to change marked dimensions without prior notice.

535mm

INSTALL THE NEW SINK

1. Preparation

WARNING: Risk of personal injury. Metal surfaces are sharp and can cause severe cuts. Use gloves and handle sink edges carefully.

For new installations:

- Cut along the line dedicated to the installation type as you desire.
- Carefully place the cutout template on the countertop in the desired position.
- Make sure the sink will not interfere with the cabinet and faucet.
- Trace the cutout template outline onto the countertop.
- Drill a pilot hole inside the cutting line. Using a jig or keyhole saw, cut along the outline to cut out the opening in the Countertop.

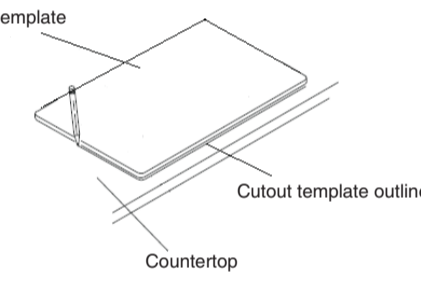

Trace the outline of the cutout template on the countertop with a pencil at the desired installation location.

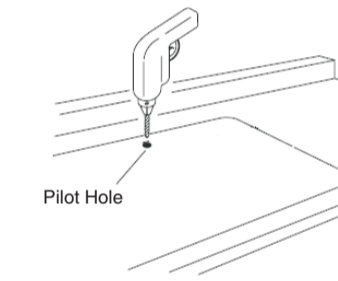

Cut along the outline to cut out the opening in the countertop

For existing installations:

- Carefully lift the old sink out of the countertop.
- Compare the existing cut-out to the required cut-out size.
- If needed, enlarge the cut-out hole according to the directions for new installations.

2. Install the Faucet Fitting and Drain

- Install the faucet overflow pipe and strainer according to the manufacturer's instructions.

NOTE: If you are reusing fittings from an old sink, use plumbers putty under the faucet base and top flange of the strainer.

3. Install the Mounting Brackets

- For laminate type countertops, make sure that all exposed non-laminated surfaces located near the cut-out area are finished and sealed in order to prevent damage from water absorption.
- Equally space the required number of mounting brackets (see chart on roughing-in page) and locate the mounting holes on the underside of the countertop 35mm from the edge of the countertop opening.
- The type of fastener needed is dependant upon the countertop material and should be recommended by the countertop supplier.
- Loosely install the mounting brackets to the countertop.
- Turn the brackets parallel to the opening to allow for easy installation of the sink.

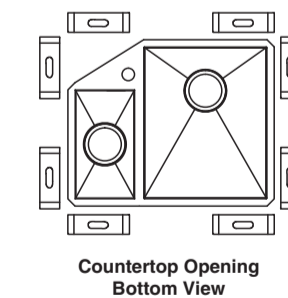
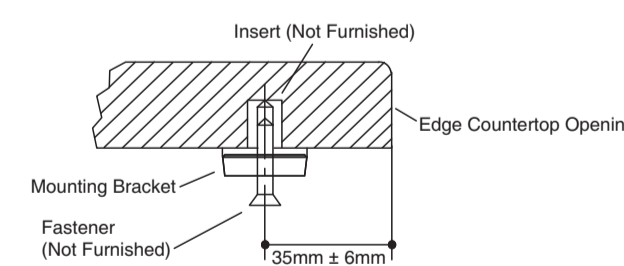

Countertop Opening Bottom View

423mm

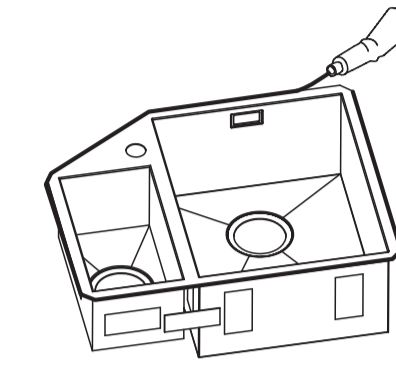

1. Drill a hole at the bottom, then put the nut into the hole.

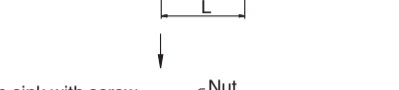

2. Fasten sink with screw

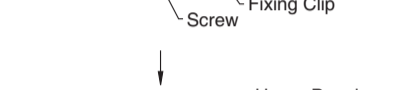

3. Install upper panel

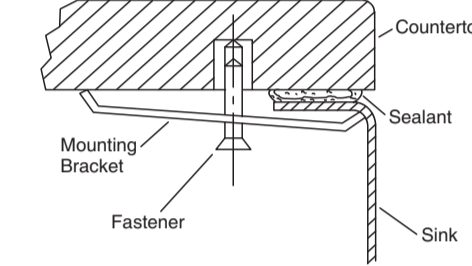
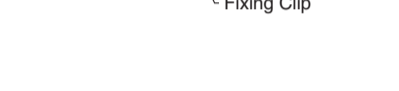

4. Apply the Sealant

- Clean all residue from the top rim of the sink.
- Clean the underside of the countertop around the cut-out area and make sure the surface is smooth and free of defects.
- Apply a generous bead of silicone or latex sealant to the rim of the sink near the inside edge.

5. Finish the Installation

- Position and align the sink with the opening in the countertop. The corner of the sink should be flush with the inside edge of the countertop.
- Rotate the mounting brackets over the sink rim.
- Tighten each bracket until snug while maintaining proper alignment.
- Wipe away any excess sealant with a dry cloth.
- Verify that there are no gaps.
- Allow the sealant to cure for a minimum of 30 minutes. Follow the instructions provided with the sealant.

6. Connect Water Supply and Test

- Install the garbage disposal, if used, according to the manufacturer's instructions.
- Connect and tighten the trap to the strainer, and complete the water supply connections to the faucet according to the instructions packed with the faucet.
- Run water into the sink and check for leaks.

CARE AND CLEANING

Stainless Steel

Rinse your stainless steel sink thoroughly after each use, and use a dabbing action to dry with a clean, soft cloth. Clean stainless steel once a week.

Always apply stainless steel cleaner/polish with a nonabrasive cloth or sponge, working with, not across the grain. **Do not** use steel wool, wire brushes or abrasive pads to clean your sink.

If you use cleaners containing chlorides, be sure to rinse the surface immediately after you clean it to avoid corrosion. **Do not** allow cleaners to remain in contact with the sink surface for long periods of time.

Kohler kitchen sink accessories, including bottom basin racks, wire rinse baskets, cutting boards and colanders will help protect the surface of your sink.

If the surface becomes excessively dirty, consider using baking soda, or a general purpose cleaner.



Kohler Mira Limited
Cromwell Road, Cheltenham, Gloucestershire, GL52 5EP, United Kingdom

EN 13310:2015
Kitchen sink made of stainless steel
Cleanability Pass
Load resistance NPD/NA
Durability Pass

CUT ALONG THIS LINE

RIM OF SINK