

## User Instructions

OVENS

---

EN

2

# Summary

---

<b>3</b>	<b>Safety Indications</b>
<b>7</b>	<b>General Instructions</b>
<b>9</b>	<b>Product description</b>
<b>10</b>	<b>Display description</b>
<b>13</b>	<b>Use of the appliance</b>
<b>15</b>	<b>Connectivity</b>
<b>19</b>	<b>General notes on cleaning</b>
<b>19</b>	<b>Maintenance</b>
<b>22</b>	<b>Troubleshooting</b>
<b>44</b>	<b>Installation</b>

## Safety Indications

---

- During cooking, moisture may condense inside the oven cavity or on the glass of the door. This is a normal condition. To reduce this effect, wait 10-15 minutes after turning on the power before putting food inside the oven. In any case, the condensation disappears when the oven reaches the cooking temperature.
- Cook the vegetables in a container with a lid instead of an open tray.
- Avoid leaving food inside the oven after cooking for more than 15/20 minutes.
- WARNING: the appliance and accessible parts become hot during use. Be careful not to touch any hot parts.
- WARNING: the accessible parts can become hot when the oven is in use. Young children should be kept at a safe distance.
- WARNING: ensure that the appliance is switched off before replacing the bulb, to avoid the possibility of electric shocks.
- Disconnect the appliance from the mains electricity supply before carrying out any work or maintenance.
- WARNING: in order to avoid any danger caused by the accidental resetting of the thermal interruption device, the appliance should not be powered by an external switching device, such as a timer, or be connected to a circuit that is regularly switched on and off.
- Children under 8 should be kept at a safe distance from the appliance if not continuously supervised.
- Children should not play with the appliance.
- The appliance can be used by those aged 8 or over and by those with limited physical, sensorial or mental capacities, without experience or knowledge of the product, only if supervised or provided with instruction as to the operation of the appliance, in a safe way with awareness of the possible risks.
- Cleaning and maintenance should not be carried out by unsupervised children.
- Do not use rough or abrasive materials or sharp metal scrapers to clean the oven door glasses, as they can scratch the surface

and cause the glass to shatter.

- The oven must be switched off before removing the removable parts. After cleaning, reassemble them according the instructions.
- Only use the meat probe recommended for this oven.
- Do not use a steam cleaner or high pressure spray for cleaning operations.
- IF THE OVEN IS PROVIDED BY THE MANUFACTURER WITHOUT PLUG:

- HE APPLIANCE MUST NOT BE CONNECTED TO THE POWER SOURCE USING PLUG OR SOCKETS, BUT MUST BE DIRECTLY CONNECTED TO THE SUPPLY MAINS. The connection to the power source must be carried out by a suitably qualified professional. In order to have an installation compliant to the current safety legislation the oven must be connected only placing an omnipolar breaker, with contact separation compliant to the requirements for overvoltage category III, between the appliance and the power source. The omnipolar breaker must bear the maximum connected load and must be in line with current legislation. The yellow-green earth cable should not be interrupted by the breaker. The omnipolar breaker used for the connection must be easily accessible when the appliance is installed.

The connection to the power source must be carried out by a suitably qualified professional considering the polarity of the oven and of the power source.

The disconnection must be achieved incorporating a switch in the fixed wiring in accordance with the wiring rules

- IF THE OVEN IS PROVIDED BY THE MANUFACTURER WITH PLUG:

The socket must be suitable for the load indicated on the tag and must have ground contact connected and in operation. The earth conductor is yellow-green in colour. This operation should be carried out by a suitably qualified professional. In case of in-

compatibility between the socket and the appliance plug, ask a qualified electrician to substitute the socket with another suitable type. The plug and the socket must be conformed to the current norms of the installation country. Connection to the power source can also be made by placing an omnipolar breaker, with contact separation compliant to the requirements for overvoltage category III, between the appliance and the power source that can bear the maximum connected load and that is in line with current legislation. The yellow-green earth cable should not be interrupted by the breaker. The socket or omnipolar breaker used for the connection should be easily accessible when the appliance is installed.

The disconnection may be achieved by having the plug accessible or by incorporating a switch in the fixed wiring in accordance with the wiring rules.

- If the power cable is damaged, it should be substituted with a cable or special bundle available from the manufacturer or by contacting the customer service department. The type of power cable must be H05V2V2-F.
- This operation should be carried out by a suitably qualified professional. The earth conductor (yellow-green) must be approximately 10 mm longer than the other conductors. For any repairs, refer only to the Customer Care Department and request the use of original spare parts.
- Failure to comply with the above can compromise the safety of the appliance and invalidate the guarantee.
- Any excess of spilled material should be removed before cleaning.
- A long power supply failure during an occurring cooking phase may cause a malfunction of the monitor. In this case contact customer service.
- The appliance must not be installed behind a decorative door in order to avoid overheating.
- When you place the shelf inside, make sure that the stop is di-

rected upwards and in the back of the cavity. The shelf must be inserted completely into the cavity.

- When inserting the grid tray pay attention that the anti-slide edge is positioned rearwards and upwards.
- **WARNING:** Do not line the oven walls with aluminium foil or single-use protection available from stores. Aluminium foil or any other protection, in direct contact with the hot enamel, risk melting and deteriorating the enamel of the insides.
- **WARNING:** Never remove the oven door seal.
- **CAUTION:** Do not refill the cavity bottom with water during cooking or when the oven is hot.
- No additional operation/setting is required in order to operate the appliance at the rated frequencies.
- The oven can be located high in a column or under a worktop. Before fixing, you must ensure good ventilation in the oven space to allow proper circulation of the fresh air required for cooling and protecting the internal parts. Make the openings specified on last page according to the type of fitting.
- For a correct use of the oven it is advisable not to put the food in direct contact with the racks and trays, but to use oven papers and/ or special containers.

# General Instructions

---

We thank you for choosing one of our products. For the best results with your oven, you should read this manual carefully and retain it for future reference. Before installing the oven, take note of the serial number so that you can give it to customer service staff if any repairs are required. Having removed the oven from its packaging, check that it has not been damaged during transportation. If you have doubts, do not use the oven and refer to a qualified technician for advice. Keep all of the packaging material (plastic bags, polystyrene, nails) out of the reach of children. When the oven is switched on for the first time, strong smelling smoke can develop, which is caused by the glue on the insulation panels surrounding the oven heating for the first time. This is absolutely normal and, if it occurs, you should wait for the smoke to dissipate before putting food in the oven. The manufacturer accepts no responsibility in cases where the instructions contained in this document are not observed.

**NOTE:** the oven functions, properties and accessories cited in this manual will vary, depending on the model you have purchased.

## Safety Indications

---

Only use the oven for its intended purpose, that is only for the cooking of foods; any other use, for example as a heat source, is considered improper and therefore dangerous. The manufacturer cannot be held responsible for any damage resulting from improper, incorrect or unreasonable usage.

The use of any electrical appliance implies the observance of some fundamental rules:

- do not pull on the power cable to disconnect the plug from the socket;
- do not touch the appliance with wet or damp hands or feet;
- in general the use of adaptors, multiple sockets and extension cables is not recommended;
- in case of malfunction and/or poor operation, switch off the appliance and do not tamper with it.

## Electrical Safety

---

**ENSURE THAT AN ELECTRICIAN OR QUALIFIED TECHNICIAN MAKES THE ELECTRICAL CONNECTIONS.** The power supply to which the oven is connected must conform with the laws in force in the country of installation. The manufacturer accepts no responsibility for any damage caused by the failure to observe these instructions. The oven must be connected to an electrical supply with an earthed wall outlet or a disconnecter with multiple poles, depending on the laws in force in the country of installation. The electrical supply should be protected with suitable fuses and the cables used must have a transverse section that can ensure correct supply to the oven.

### CONNECTION

The oven is supplied with a power cable that should only be connected to an electrical supply with 220-240 Vac power between the phases or between the phase and neutral. Before the oven is connected to the electrical supply, it is important to check:

- power voltage indicated on the gauge;
- the setting of the disconnecter.

The grounding wire connected to the oven's earth terminal must be connected to the earth terminal of the power supply.

## **WARNING**

Before connecting the oven to the power supply, ask a qualified electrician to check the continuity of the power supply's earth terminal. The manufacturer accepts no responsibility for any accidents or other problems caused by failure to connect the oven to the earth terminal or by an earth connection that has defective continuity.

**NOTE:** as the oven could require maintenance work, it is advisable to keep another wall socket available so that the oven can be connected to this if it is removed from the space in which it is installed. The power cable must only be substituted by technical service staff or by technicians with equivalent qualifications.

A low light around the central main switch could be present when the oven is off. This is a normal behavior. It can be removed just turning the plug upside down or swapping the supply terminals.

## **Recommendations**

---

After each use of the oven, a minimum of cleaning will help keep the oven perfectly clean.

Do not line the oven walls with aluminium foil or single-use protection available from stores. Aluminium foil or any other protection, in direct contact with the hot enamel, risks melting and deteriorating the enamel of the insides. In order to prevent excessive dirtying of your oven and the resulting strong smokey smells, we recommend not using the oven at very high temperature. It is better to extend the cooking time and lower the temperature a little. In addition to the accessories supplied with the oven, we advise you only use dishes and baking moulds resistant to very high temperatures.

## **Installation**

---

The manufacturers have no obligation to carry this out. If the assistance of the manufacturer is required to rectify faults arising from incorrect installation, this assistance is not covered by the guarantee. The installation instructions for professionally qualified personnel must be followed. Incorrect installation may cause harm or injury to people, animals or belongings. The manufacturer cannot be held responsible for such harm or injury.

The oven can be located high in a column or under a worktop. Before fixing, you must ensure good ventilation in the oven space to allow proper circulation of the fresh air required for cooling and protecting the internal parts. Make the openings specified on last page according to the type of fitting.

## **First Use**

---

**PRELIMINARY CLEANING;** Clean the oven before using for the first time. Wipe over external surfaces with a damp soft cloth. Wash all accessories and wipe inside the oven with a solution of hot water and washing up liquid. Set the empty oven to the maximum temperature and leave on for about 1 hour, this will remove any lingering smells of newness.

## Product description

---

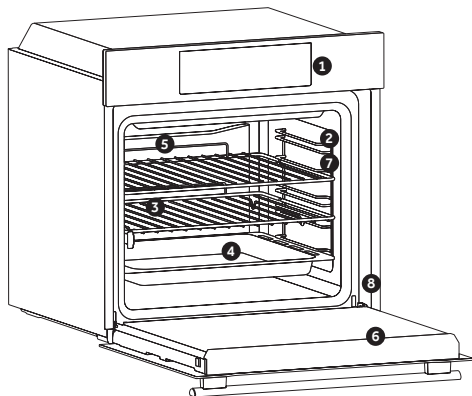

1. Control panel
2. Shelf positions (lateral wire grid if included)
3. Grids
4. Trays
5. Fan (if present)
6. Oven door
7. Lateral wire grids (if present: only for flat cavity)
8. **Serial number**

### ACCESSORIES

#### Drip tray

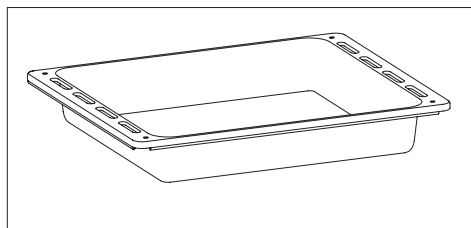

Collects residues that drip when cooking food on the grills.

#### Metal grid

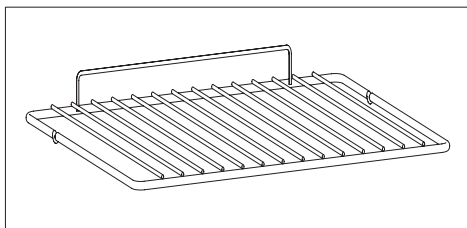

Holds baking trays and plates.

#### Lateral wire grids (only if present)

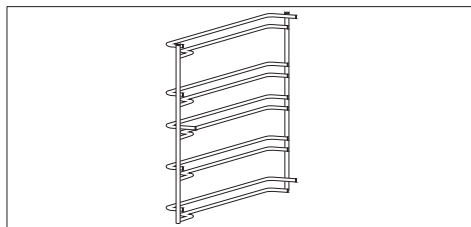

Located on both sides of the oven cavity, holds metal grills and drip pans.

# Display description



ON / OFF ① - The oven is switched on and off with this button.

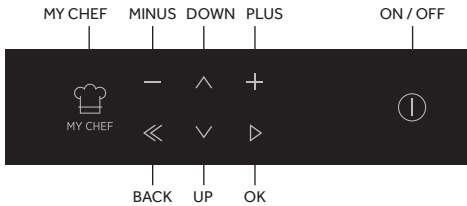

- If the oven is switched off, the display shows the clock. When the oven is inactive, all the functions are available except the cooking duration and end of cooking.
- If the clock is not set, the oven does not work: the display flashes, showing "12:00".

## Product Setting

• At first launch you need to follow an installation process to be able to use the oven. Press ON/OFF to go ahead. (Figure 1)

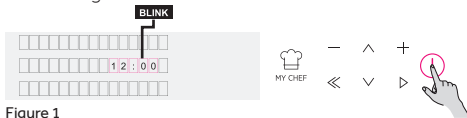

Figure 1

• Please enter in the settings section and select the language from the drop down menu (Figure 2).

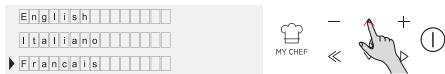

Figure 2

• Press OK to go ahead. (Figure 3)



Figure 3

• Set the time by pressing the PLUS and MINUS buttons. Press OK to go ahead. (Figure 4)

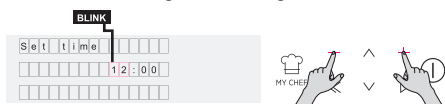

Figure 4

• The installation process is completed. Press OK then go to home page to start use the oven.

For more details please check the related quick guide.

## Operating In Manual Mode

• Press the OK button when arrow on the display at MANUAL to set a cooking in 3 simple steps. (Figure 5)

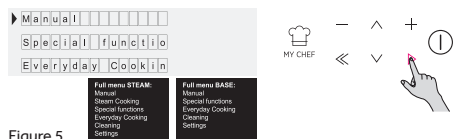

Figure 5

• Select the desired Cooking mode by pressing OK while arrow on the display at desired function. Press DOWN in order to see all available functions. (Figure 6)



Figure 6

• Press PLUS or MINUS to select the desired temperature in selected function. Press OK to go ahead or BACK to return to the cooking functions selection. (Figure 7)



Figure 7

• Press DOWN to change the cooking duration. It is done by pressing PLUS and MINUS Buttons while arrow on the display at DURATION Tab. Press OK to begin the cooking or BACK to return to the temperature setting. (Figure 8)



Figure 8

- In the OPTIONS, it is possible to:
  - exclude pre heating,
  - set end of cooking time.
- When a cooking is running you can:
  - change the temperature
  - change the cooking duration
  - press STOP to finish the cooking



## Operating In Everyday Cooking Mode

- Navigate the HOME menu till reaching the Everyday Cooking area
- Enter the area and navigate to select the preparation.

Please note that Everyday Cooking is available in the UI and in APP.

Please consider that time can be modified according to consumer needs.



## Operating In Special Functions Mode

- Please refer to chapter Cooking modes.

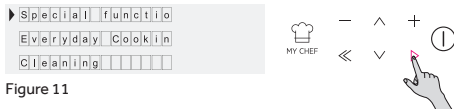

## Operating In My Chef Mode

- Please refer to chapter Function Descriptions.





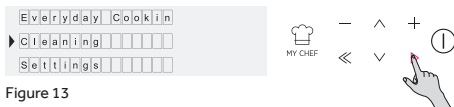

## Operating In Cleaning System Mode

- Please refer to chapter Cooking Modes













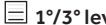

# Function Descriptions

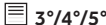
FUNCTION	DESCRIPTION
	<p><b>KEY LOCK</b></p> <p>Entering in the setting menu from the home page or during a cooking, by pressing together MY-CHEF and START buttons for 3 seconds it is possible to lock the user interaction apart from ON/OFF button. When the key lock is set the icon is on. To unlock use the same key combination.</p>
	<p><b>MEAT PROBE</b></p> <p>If the meat probe is detected (by the Sys Info message) the icon is switched on and any running cooking program is stopped. If the meat probe is removed while a cooking program is running, the program is stopped and return to home menu.</p>
	<p><b>WIFI</b></p> <p>Entering in wifi menu from the home page, with this function it is possible to set the WiFi. See the dedicated chapter.</p>
	<p><b>LOCK</b></p> <p>At the end of a pyrolysis or if the pyrolysis is interrupted, it is not possible to start any program until the door is unlocked.</p> <p>Pyrolysis is not available if separator or side grids or the meat probe are detected, and by WiFi; if this happens during a pyrolysis, the pyrolysis is stopped.</p> <p>When the door is locked the icon of the padlock is switched on.</p>
 MY CHEF	<p><b>MY CHEF</b></p> <p>With this button, when the oven is not off or it is not cooking, it is possible to enter in a special menu where there are:</p> <ul style="list-style-type: none"> <li>• "MY RECIPES" (that is a list of stored recipes, max 5; if no recipe is stored an invalid tone is played),</li> <li>• "LAST USED" (that is the last cooking program used; if no program is stored an invalid tone is played)</li> <li>• "LAST USED ON APP" (that is the last program received by App; if no programs were received an invalid tone is played)</li> </ul>

# Use of the appliance

## COOKING MODES \*









Symbol	Description	Suggestions
	<b>Conventional ***</b> <b>160-200°C **</b>  2° level	IDEAL FOR: brioche, croissants, flans, puddings, creams. This function uses both top and bottom heating elements. Preheat the oven for 10 minutes.
	<b>Convection + Fan</b> <b>240°C **</b>  1° level	IDEAL FOR: pizza, focaccia, lasagna. This function distributes heat better due to the combination of fan and heating elements, ensuring evenly baked results.
	<b>Multi-level</b> <b>180-200°C **</b>  1°/3° level	IDEAL FOR: pastries, biscuits, cakes, stuffed and braised. Use this function to cook different foods at the same time on one or more shelf positions. Heat is distributed better and penetrates food better, reducing both preheating and cooking times. Aromas are not mixed. Allow about 10 minutes extra when cooking different foods together.
	<b>Grill</b> <b>L5 (power) **</b>  3°/4°/5° level	IDEAL FOR: gratin, grilled meat, fish, vegetables. This function uses only the top heating element, and the grill level can be adjusted. Use with the door closed. Place white meats at a distance from the grill. Red meats and fish filets can be placed on the shelf with the drip tray underneath. Preheat for 5 minutes. If this function is selected, it is not possible to set the delayed start with start / stop time.
	<b>Grill + Fan</b> <b>200°C **</b>  4° level	IDEAL FOR: whole pieces of meat (roasts). Uses the top heating element with the fan to circulate the air inside the oven. Use with the door closed. Slide the drip tray under the shelf to collect juices. Turn food over halfway through cooking. Preheating is required for red meats but not for white meats.
	<b>Bottom heating</b> <b>160-180°C **</b>  2° level	IDEAL FOR: caramel cream, puddings, bavarian cream (bain marie). This function is ideal to cook all pastry-based dishes, which need more heat from below. It can also be used to finish a cooking preparation.
	<b>Bottom heating + Fan</b> <b>210°C **</b>  1° level	IDEAL FOR: tarts. The bottom heating element is used with the fan circulating the air inside the oven. It prevents food from drying and encourages the rising process for perfect results.

\* Depending on the oven model.

\*\* Ideal temperature for suggested foods.

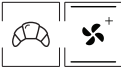
\*\*\* Tested in accordance with the EN 60350-1 for the purpose of energy consumption declaration and energy class.

## SPECIAL FUNCTIONS \*

Symbol	Description	Suggestions
	<b>Master bake ***</b> <b>180-200°C **</b>  2° level	Ideal to keep food soft inside and crunchy outside. For healthy cooking, this function reduces the amount of fat or oil required. The combination of heating elements with a pulsating cycle of air ensures even baking results.
	<b>Defrost</b> <b>40°C</b>  2° level	The fan circulates air at 40°C temperature around frozen food so that it defrosts without altering food properties.
	<b>Convection+</b> <b>180-200°C *</b>  2° level	IDEAL FOR: cakes, bread, biscuits, croissants, brioche. Combines a first phase of traditional cooking followed by cycles at varying fan speeds.
	<b>Leavening</b> <b>40°C</b>  2° level	IDEAL FOR: bakery. Uses the top and bottom heating elements to warm the oven cavity very gently, ensuring bread or baked foods rise.

# Connectivity

---

## WIRELESS PARAMETERS

Technology	Wi-Fi	Bluetooth
Standard	IEEE 802.11 b/g/n	Bluetooth v4.2, BR/EDR, BLE
Frequency Band(s) [MHz]	2401-2483	2402-2480
Maximum Power [mW]	100	10

## PRODUCT INFORMATION FOR NETWORKED EQUIPMENT

- Power consumption of the product in networked standby if all wired network ports are connected and all wireless network ports are activated: 2,0 W

### How to activate wireless network port:

- Navigate to settings > WiFi
- If the oven is not enrolled the display shows 2 possible ways to enrol the oven: standard and easy.
  1. Press plus or minus button to select one of them and press the confirm button to start the enrollment.
  2. WiFi module is switched on, the UI shows the message "Enrollment in progress" and WiFi icon blinks 0,5s on, 0,5s off, 0,5s on, 1s off.
  3. When enrollment is completed display shows setting screen and WiFi icon is always on.
- If the oven is enrolled but the WiFi module is off, the display shows WiFi Off.
  1. Press plus or minus button to toggle to WiFi On and press the confirm button.
  2. WiFi module is switched on and WiFi icon is always on

### How to deactivate wireless network port:

- Navigate to settings > WiFi
- If the oven is enrolled and WiFi module is on, display shows WiFi On.
  1. Press plus or minus button to toggle to WiFi Off and press the confirm button.
  2. WiFi module is switched off and WiFi icon is always off.
- If the oven is not enrolled the WiFi module is off and the WiFi icon is off.

# Oven enrollment on app

---

## ON THE SMARTPHONE

### Step 1

- Download hOn app



### Step 2

- Log in or sign up.

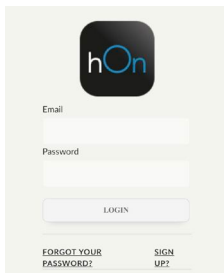

### Step 3

- Add new appliance

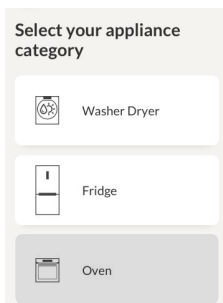

### Step 4

- Scan the QR code or insert the serial number



Write here your serial number for future reference.

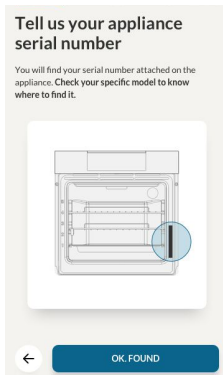

## ON THE APPLIANCE

### Step 5

- Scroll the menu and select the option SETTINGS with the button ►

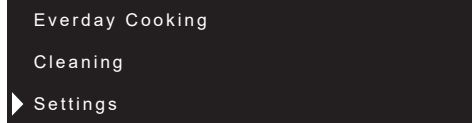

### Step 6

- In the same way select the option WIFI with the button ►



### Step 7

- To navigate within the EASY or STANDARD ENROLLMENT options, click the + button.

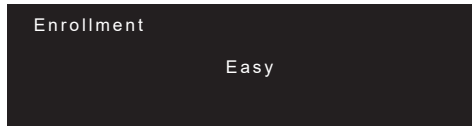

- Option 1: Select EASY ENROLLMENT and confirm by pressing the ► button. (the oven will beep)

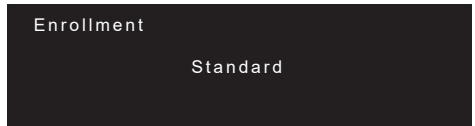

- Option 2: Select STANDARD ENROLLMENT and confirm by pressing the ► button. (the oven will beep)

### Step 8

- The WIFI icon will blink

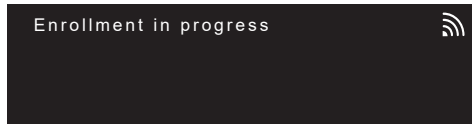

### NOTE:

- Make sure to have minimum a 2.4GHz Home Wi-Fi network.
- Make sure to have your Home Wi-Fi password and name ready. You will need them later.
- Make sure your appliance is in a place where there is an excellent Home Wi-Fi signal.
- And yes, stay close to your appliance.

# Remote control mode

---

## Step 1

- Scroll the menu and select the option SETTINGS with the button ►

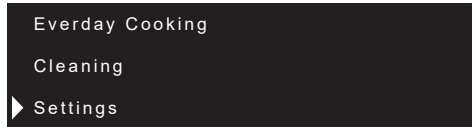

## Step 2

- From settings menu, select the option Remote Control with the ► button

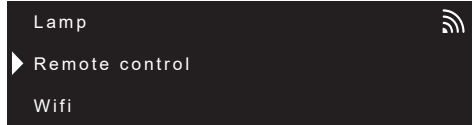

## Step 3

- Set the oven on Remote Control ON with the + button

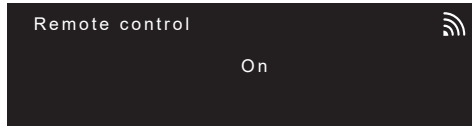

## Step 4

- confirm the selection with ►

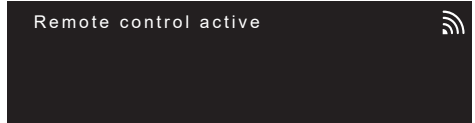

## NOTE:

To activate, deactivate or reset the WiFi see info on page EN 16 of this document.

---

Hereby, Candy Hoover Group Srl declares that the radio equipment is in compliance with Directive 2014/53/EU and with the relevant statutory requirements for the UK market. The full text of the declaration of conformity is available at the following internet address: [www.candy-group.com](http://www.candy-group.com)

## General notes on cleaning

---

The lifecycle of the appliance can be extended through regular cleaning. Wait for the oven to cool before carrying out manual cleaning operations. Never use abrasive detergents, steel wool or sharp objects for cleaning, so as to not irreparably damage the enamelled parts. Use only water, soap or bleach-based detergents (ammonia).

### GLASS PARTS

It is advisable to clean the glass window with absorbent kitchen towel after every use of the oven. To remove more obstinate stains, you can use a detergent-soaked sponge, well wrung out, and then rinse with water.

### OVEN WINDOW SEAL

If dirty, the seal can be cleaned with a slightly

damp sponge.

### ACCESSORIES

Clean accessories with a wet, soapy sponge before rinsing and drying them: avoid using abrasive detergents.

### DRIP PAN

After using the grill, remove the pan from the oven. Pour the hot fat into a container and wash the pan in hot water, using a sponge and washing-up liquid.

If greasy residues remain, immerse the pan in water and detergent. Alternatively, you can wash the pan in the dishwasher or use a commercial oven detergent. Never put a dirty pan back into the oven.

## Maintenance

---

### REMOVAL AND CLEANING OF THE SIDE RACKS

1. Remove the wire racks by pulling them in the direction of the arrows (see below)
2. To clean the wire racks either put them in the dishwasher or use a wet sponge, ensuring that they are dried afterwards.
3. After the cleaning process install the wire racks in reverse order."

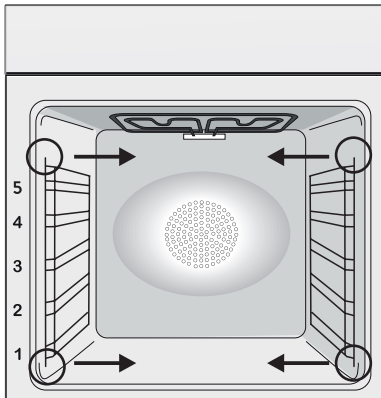

### CHANGING THE BULB

1. Disconnect the oven from the mains supply.
2. Undo the glass cover, unscrew the bulb and replace it with a new bulb of the same type.
3. Once the defective bulb is replaced, replace the glass cover.

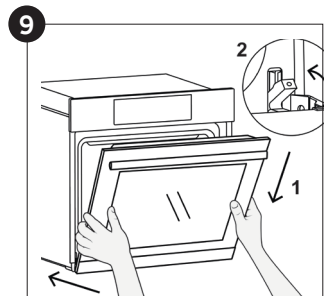
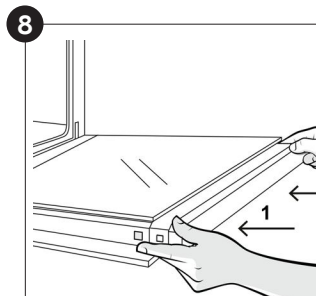
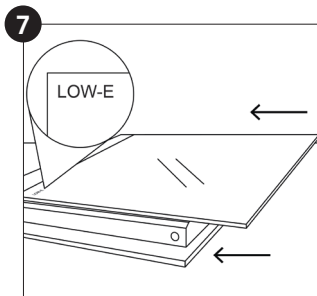
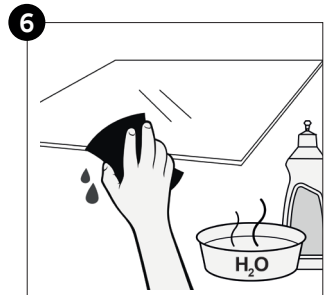
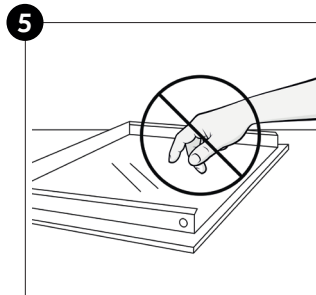
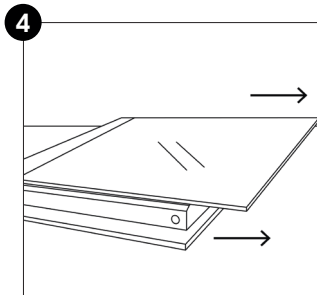
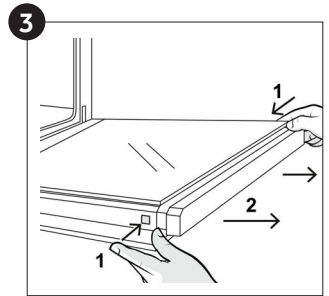
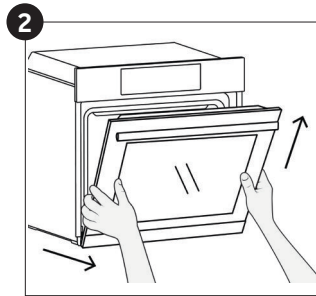
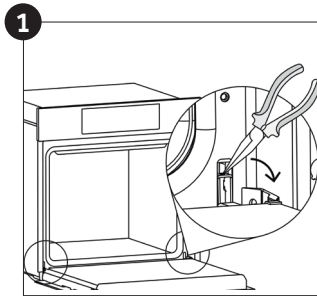

This product contains one or more light sources of energy efficiency class G (Lamp) /F (10 Led).

1. Open the door 90° and pull the hinge fixing tabs toward the outside of the oven.
2. Put the door at a 45° angle, then pull the door forwards and upwards at the same time to release it. Remove the oven door and place it on a cushioned surface (e.g. on top of a piece of fabric) with the handle facing down.
3. Press the two buttons on the left and right at the same time and pull the upper door cover towards you to remove it.
4. Carefully remove the glass inside the oven, holding it firmly with two hands and placing it on a soft, flat surface.
5. If there are glass panels in between, remove them and place them on a soft surface.
- ATTENTION: the outer panel of glass is not removable
6. Clean the glass with a soft cloth using an appropriate cleaning product.
7. After cleaning, reassemble the parts in the opposite order to removal. On all glass panels, the "Low-E" indication must be correctly legible and positioned on the left side of the door, near the left side hinge.
8. This ensures that the printed label on the first glass panel remains inside the door.
9. Refit the oven door cover by pushing inwards until you hear the two side buttons click into place.
10. Holding the door at 45°, simultaneously insert the right and left male parts of the hinge into the holes of the hinges released, until you hear them click in place. Bring the door to an angle of 90° and lock the fixing tabs in place by pushing them towards the inside of the oven.



# Hydro Easy Clean Function

The HYDRO EASY CLEAN procedure uses steam to help remove remaining fat and food particles from the oven.

1. Pour 300 ml of water into the HYDRO EASY CLEAN container at the bottom of the oven.
2. Set the oven function to Static (  ) or Bottom (  ) heater
3. Set the temperature to the HYDRO EASY CLEAN icon 
4. Allow the program to operate for 30 minutes.
5. After 30 minutes switch off the program and allow the oven to cool down.
6. When the appliance is cool, clean the inner surfaces of the oven with a cloth.

Warning: Make sure that the appliance is cool before you touch it.

Care must be taken with all hot surfaces as there is a risk of burns.

Use distilled or drinkable water.



# Waste management and environmental protection



This appliance is labelled in accordance with European Directive 2012/19/EU regarding electric and electronic appliances (WEEE). The WEEE contain both polluting substances (that can have a negative effect on the environment) and base elements (that can be reused). It is important that the WEEE undergo specific treatments to correctly remove and dispose of the pollutants and recover all the materials. Individuals can play an important role in ensuring that the WEEE do not become an environmental problem; it is essential to follow a few basic rules:

- the WEEE should not be treated as domestic waste;

- the WEEE should be taken to dedicated collection areas managed by the town council or a registered company.

In many countries, domestic collections may be available for large WEEEs. When you buy a new appliance, the old one can be returned to the vendor who must accept it free of charge as a one-off, as long as the appliance is of an equivalent type and has the same functions as the purchased appliance.

## SAVING AND RESPECTING THE ENVIRONMENT

Where possible, avoid pre-heating the oven and always try to fill it. Open the oven door as infrequently as possible, because heat from the cavity disperses every time it is opened. For a significant energy saving, switch off the oven between 5 and 10 minutes before the planned end of the cooking time, and use the residual heat that the oven continues to generate. Keep the seals clean and in order, to avoid any heat dispersal outside of the cavity. If you have an electric contract with an hourly tariff, the "delayed cooking" programme makes energy saving more simple, moving the cooking process to start at the reduced tariff time slot.

## Troubleshooting

Problem	Possible cause	Solution
the oven does not heat up	The clock is not set	Set the clock
The oven does not heat up	A cooking function and temperature has not been set	Ensure that the necessary settings are correct
No reaction of the touch user interface	Steam and condensation on the user interface panel	Clean with a microfiber cloth the user interface panel to remove the condensation layer

# Installation

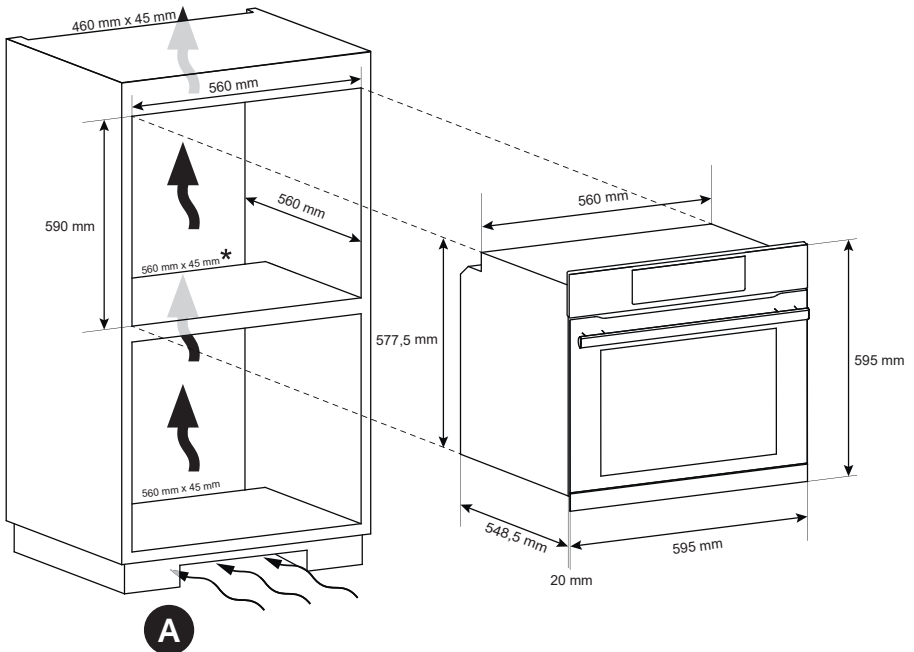
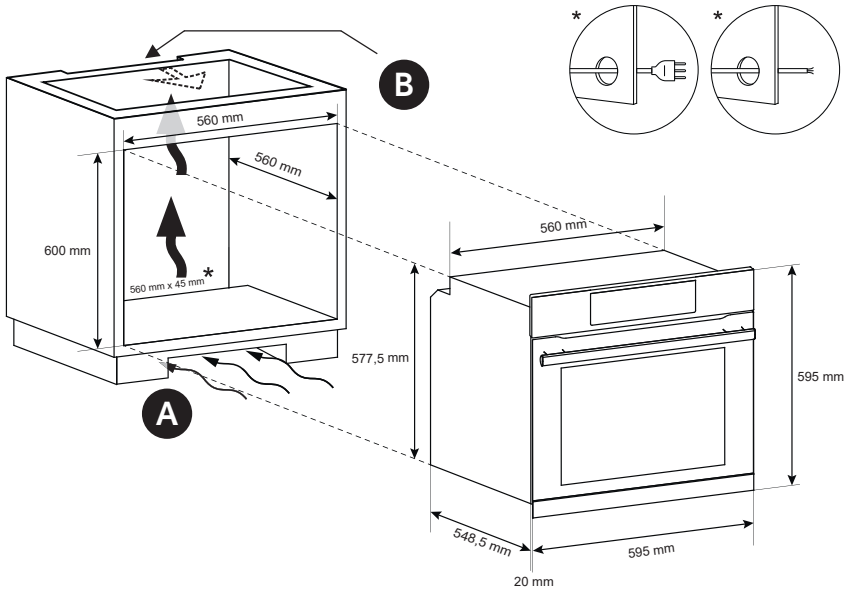



**EN** If the furniture is coverage with a bottom at the back part, provide an opening for the power supply cable.

**EN** If the oven does not have a cooling fan, create an opening 460 mm x 15 mm

**EN** If the mounting of the plinth does not allow air circulation, it is necessary to create an opening of 500x10 mm or the same surface in 5000 mm<sup>2</sup>.

2.

**EN** The manufacturer will not be responsible for any inaccuracy resulting from printing or transcript errors contained in this brochure. We reserve the right to carry out modifications to products as required, including the interests of consumption, without prejudice to the characteristics relating to safety or function.



70013879

