

hansgrohe

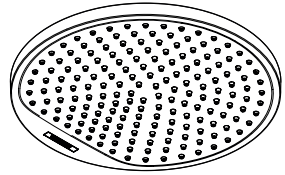

Crometta S 240 1jet

26723XXX

Crometta S 240 1jet Eco

26724XXX

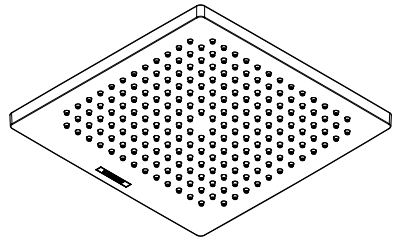

Crometta E 240 1jet

26726XXX

Crometta E 240 1jet Eco

26727XXX





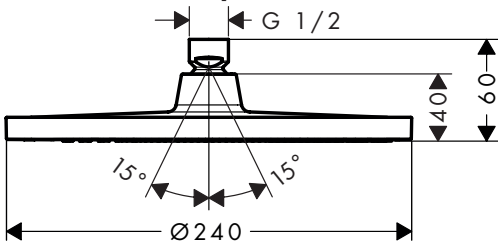

Crometta S 240 1jet 26723XXX
Crometta S 240 1jet Eco 26724XXX

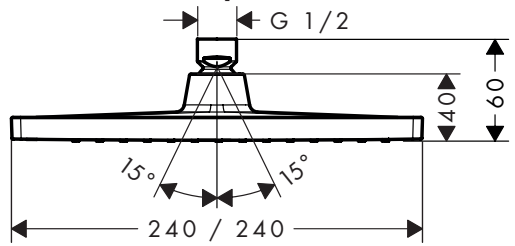

Crometta E 240 1jet 26726XXX
Crometta E 240 1jet Eco 26727XXX

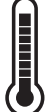

	P max. 0,6 MPa 6 bar	0,1 - 0,4 MPa 1 - 4 bar	
	T max. 60 °C	< 50 °C	

Crometta S 240 1jet 26723XXX

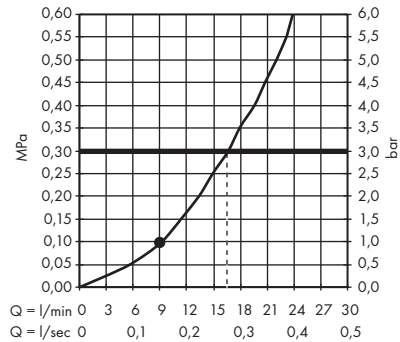

Crometta E 240 1jet 26726XXX

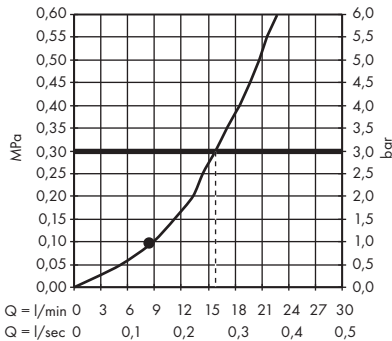

Crometta S 240 1jet Eco 26724XXX

Crometta E 240 1jet Eco 26727XXX

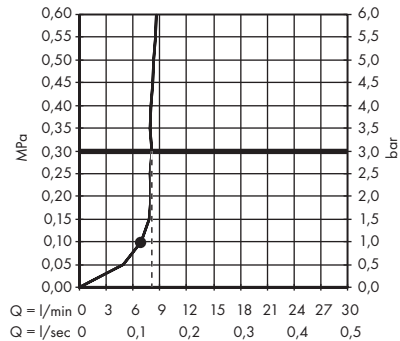

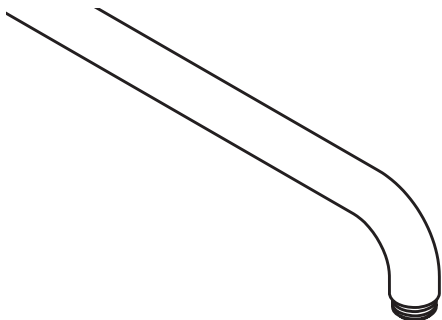

 #94246000

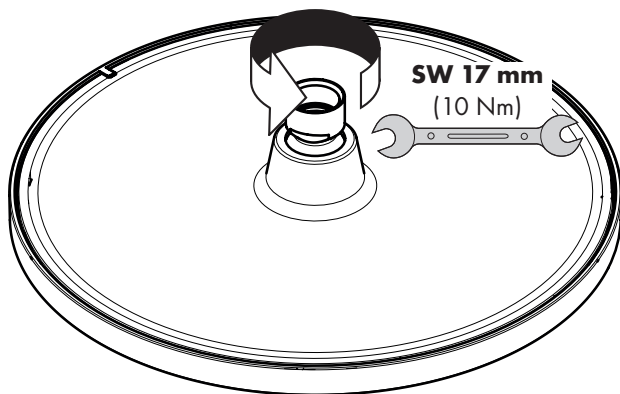

P-IX

DVGW SINTEF NF







ETA



GODKENDT TIL DRIKKEVAND

26723XXX	P-IX 29847/IB	X
26724XXX	P-IX 29848/IIZ	X
26726XXX	P-IX 29849/IB	X
26727XXX	P-IX 29850/IIZ	X

Hansgrohe SE	Hansgrohe SE	Hansgrohe SE	Hansgrohe SE
DIN 4109-1	DIN 4109-1	DIN 4109-1	DIN 4109-1
PA-IX 29847/IB	PA-IX 29848/IIZ	PA-IX 29849/IB	PA-IX 29850/IIZ
			
Products	Products	Products	Products

