

Instruction Manual

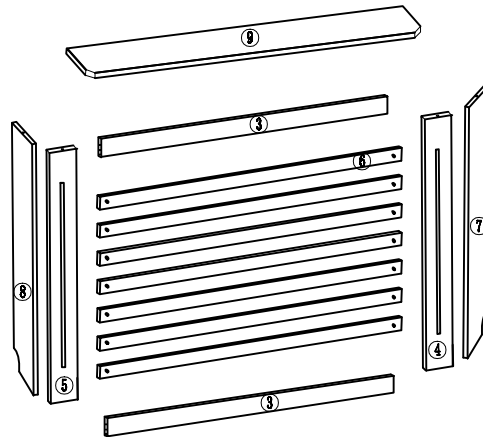

Tools needed

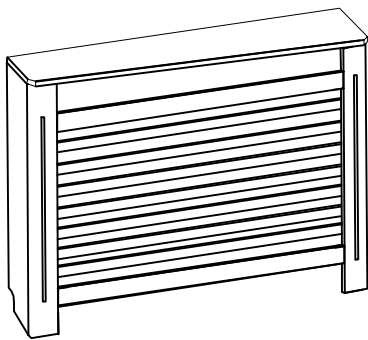
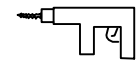

churn drill

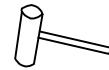

hammer

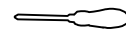

cross screwdriver

Please note that there is no No.1 and No.2 panel !

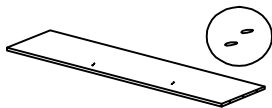

③ x2 527*105*12mm

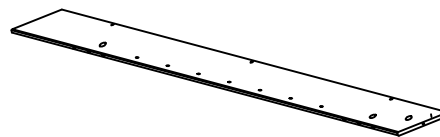

④ x1 803*110*12mm

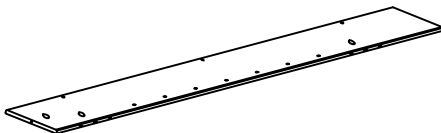

⑤ x1 803*110*12mm



⑥ x7 587*37*9mm

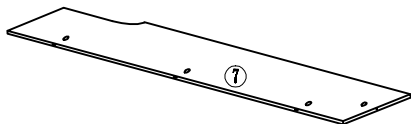

⑦ x1 803*168*12mm

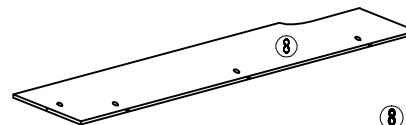

⑧ x1 803*168*12mm

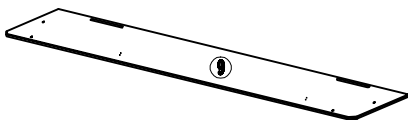

⑨ x1 780*190*12mm



Ax2



Bx14



Cx14

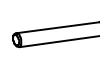

Dx8



Ex14



Fx4



Gx4



Hx2



Ix8



Using a screwdriver, screw in the #B screws securely. Please do not over tighten as it may cause wood to splinter.
 The small arrow on the #C Cam Locking Screw should be facing the #B screws extending from the panel.
 Use screwdriver to tighten securely, but avoid over tightening, screws may protrude through the panel.

1 2

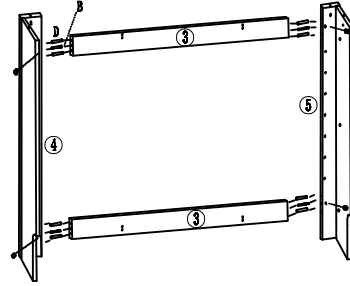
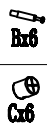
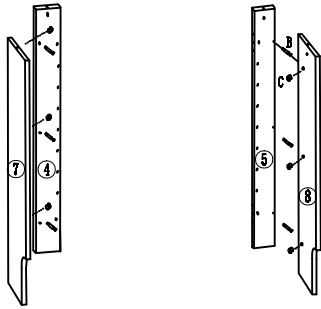

3 4

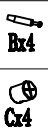
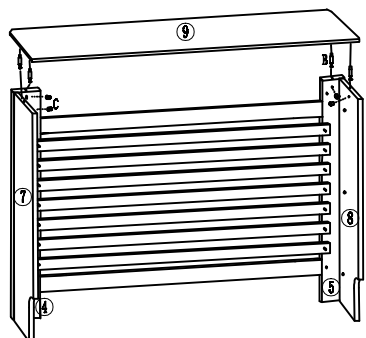
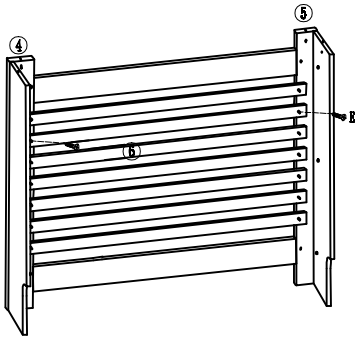

5 6

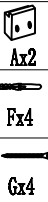
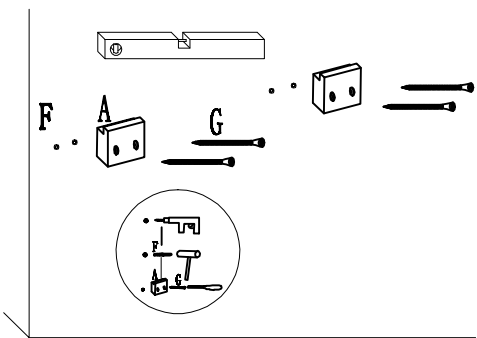
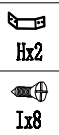
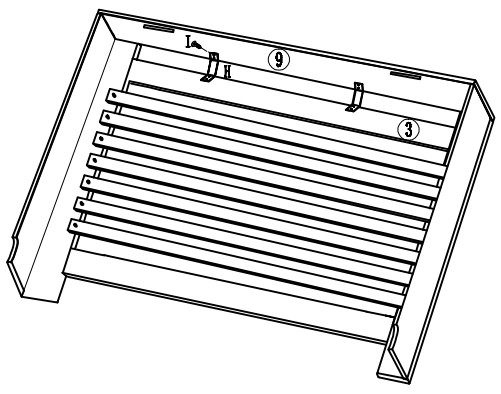

7

