

LPIORF & DIGISTAT+2RF

Radio frequency controlled programmable room thermostat with domestic hot water programmer

Part number RF560DR



Spares Part number 22589DR

Spares Part number 22090

Support

401 Southway Drive
Plymouth
PL6 6QT
United Kingdom

Technical: +44(0)333 6000 622

customer.care@draytoncontrols.co.uk
www.draytoncontrols.co.uk

@DraytonHeating
/DraytonControls

Drayton
by Schneider Electric



For GREENSTAR CDi, GREENSTAR i JUNIOR and GREENSTAR Si MODELS also GREENSTAR i SYSTEM and GREENSTAR CDi SYSTEM MODEL (only when used with the optional integral diverter).

401 Southway Drive
Plymouth
PL6 6QT
United Kingdom

Technical: +44(0)333 6000 622

customer.care@draytoncontrols.co.uk
www.draytoncontrols.co.uk

 @DraytonHeating
 /DraytonControls



PLEASE READ THESE INSTRUCTIONS CAREFULLY BEFORE STARTING.

These instructions are applicable to the Drayton model(s) stated on the front cover of this manual only and must not be used with any other make or model.

These instructions apply in the UK only and should be followed except for any statutory obligation.

If you are in any doubt contact the Drayton technical helpline.

This accessory must be fitted by a competent person. Failure to comply could lead to prosecution.

Leave these instructions with the user or at the appliance.

Abbreviations

CH	=	Central Heating
DHW	=	Domestic Hot Water
RF	=	Radio Frequency
DLS	=	Daylight Saving
BST	=	British Summer Time
GMT	=	Greenwich Mean Time
C	=	Celsius (Centigrade)
IP	=	Ingress Protection
V	=	Volt
m	=	metre
mA	=	milliAmpere

Definitions (DLS/BST)

Summer time begins: Last Sunday in March at 1:00 am GMT (Clocks are put forward by 1 hour)

Summer time ends: Last Sunday in October at 2:00 am BST (Clocks are put back by 1 hour)

Protect your environment



Schneider Electric 35 Rue
Joseph Monier
France-92500 Rueil
Malmaison

se.com/contact

Battery recycling

Electronic devices and batteries, rechargeable or not, should not be disposed of into ordinary household waste. Instead, they must be recycled properly to protect the environment and cut down the waste of precious resources. Your local waste management authority can supply details concerning the proper disposal of batteries.

Symbols



Domestic Hot Water



Radio Frequency (RF) Transmitter

Technical Data	2
----------------------	---

 Installation Guide	3
LPIORF Installation	4
Wireless Commissioning & Signal Strength.....	5-6
Signal Strength	7
Installer Options.....	8-9

 User Guide	10
DIGISTAT+2RF Room Thermostat	11
Controls and Display Layout	12
Basic Settings	13-15
User Options	15-19
Battery Change	19
LPIORF Programmer & Receiver	20
The Standard Program	21
Changing the Program	22-25

Maintenance.....	25
------------------	----

Technical Data

	Digistat +2RF Transmitter Thermostat	LPIORF Receiver
Dimensions	137mm x 96.5mm x 31.3mm	--
Power supply	2xAA 1.5V alkaline batteries	24Vd.c. less than 65mA
Radio frequency	433 MHz	433 MHz
Radio signal range	30m typically. The range may be affected by the composition / density and number of walls between the Digistat+2RF and LPIORF.	
Temperature range	5°C to 32°C	--
Ambient operating temperature	0°C to +40°C	0°C to +50°C
Humidity operating range	25 - 90% non condensing up to 45°C	30 - 95% non condensing up to 45°C
Class of operation	--	II
Degrees of protection	IP30	IP24
Control Accuracy	+0.5°C @ 20°C	Better than ±1 second per day @ 25°C
Battery life (with alkaline batteries)	approx. 2 years	N/A
Battery back up time and date	10 years min.	10 years min.
Shortest switching period	1 minute	1 minute
Hot water pre-heat settings	--	3 ON / 3 OFF
Central heating settings	6 per day	--
Energy Class	IV = 2% (Acc. EU 8II/2013, 8I2/2013, 8I3/2013, 8I4/2013)	
Pollution Class	2	2
Software Class	A	A
Ball pressure test	90°C	90°C
Software version	67I2056	--
Max. radiated power	+7.5 dBm (5.6mW)	--

Relevant EU Directives:

2014/53/EU RED
2006/66/EU Battery Directive
2011/65/EU RoHS Directive
2012/19/EU WEEE Directive

Applied Standards:

EN60730-1; EN60730-2-7; EN60730-2-9
EN 300 220-2; EN 301 489-3

Pack Contents:

LPIORF Programmer / RF receiver
Digistat+2RF transmitter
Screws (x2)
Wall Plugs (x2)
Instructions
Batteries (x2) AA Alkaline

Hereby, Schneider Electric Controls UK Limited, declares that this programmable room thermostat is in compliance with the essential requirements and other provisions of RED Directive 2014/53/EU.

Declaration of conformity can be downloaded at: www.draytoncontrols.co.uk.



Installation Guide

LPIORF & DIGISTAT+2RF

LPIORF Installation



DANGER:

230 volts do not touch the electrical components or circuits.



CAUTION:

Isolate the mains electricity supply before starting any work and observe all relevant safety precautions.

Observe electro-static discharge precautions: do not touch the pcb circuit.

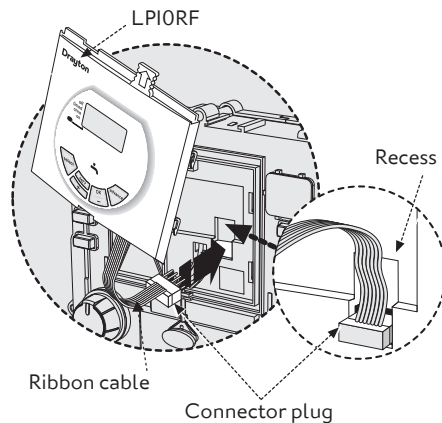
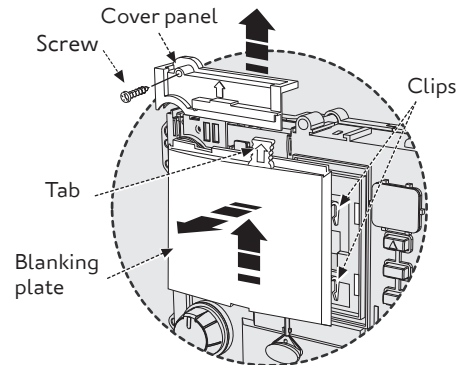

NOTE:

This accessory must be fitted by a competent person. Failure to comply could lead to prosecution.

- 1 Remove the boiler outer casing and control panel fascia to gain access to the boiler control panel.
- 2 Release the securing screws.
- 3 Pull the cover panel up to remove.
- 4 Grip the tab and pull upwards to disengage clips, pull forward to remove blanking plate or existing programmer.
- 5 Align the connector plug pins into socket on the PCB and push fully home.
- 6 Feed the ribbon cable into the recess.
- 7 Align the programmer and locate the clips, push into the slots then down to secure.
- 8 Locate the cover panel in place and secure with the screw.
- 9 Replace fascia cover and outer casing before switching on the electrical supply and boiler.
- 10 Switch boiler on when completed.

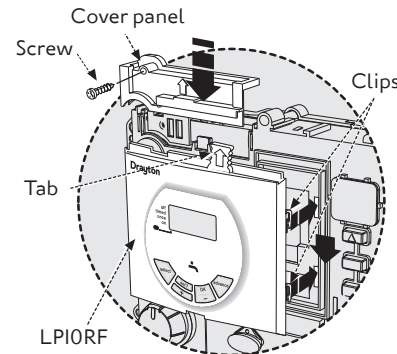

Wireless Commissioning & Signal Strength

NOTE:

Before fixing the DIGISTAT+2RF to the wall it is recommended to first check the signal strength from that location.

Wireless commissioning: after initial start up, the colon, CH and antenna symbols should be flashing on the LPIORF display.



Follow either 1 OR 1a to 1c below

- 1 Press & hold the set? button for 5s and Lrn and OFF will be displayed.

OR

- 1a Press the set? button 4 times.
- 1b Press the OK button once.
- 1c Press the set? button 4 times; Lrn and OFF will be displayed.



- 2 Press the + button so the display shows ON and a flashing antenna symbol. The learn mode is now ready to receive a signal from the transmitter during the next two minutes.



- 3 Take the Digistat+2RF unit and stand near the boiler.
- 4 Remove the battery cover and fit the batteries.



- 5 The symbols on the LPIORF will stop flashing and the display will show 'SSI, Antenna and ON'.

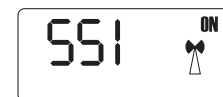

NOTE:

If you want to exit to the home screen now without checking the signal strength then please press the 'OK/-' button, then the 'set?' button. Alternatively, you can leave for 2mins and the LPIORF will automatically return to the home screen. See p.6 for how to mount the Digistat to the wall.

If you want to check the signal strength now, please continue to 6.

- 6 Press 'SET' on the LPIORF and the display will show 'SSI and Antenna'.
- 7 After a few seconds the display will show '- - -'. Remove the batteries from the Digistat+2RF, press and hold the '+' button whilst refitting the batteries, keep the '+' button held and after a few seconds the display will show 'rF' which indicates that the DIGISTAT+2RF is continuously sending a signal to the LPIORF (receiver).

The LPIORF display will now show the 'learnt' transmitter code and the antenna' as well as the signal strength as indicated by the chevrons on the right hand side of the display.

- 8 Place the Digistat+2RF in the desired final position and return to the boiler to check the LPIORF display. The ideal Digistat+2RF position will result in the LPIORF display showing 4 chevrons and the LED will be green.
- 9 If the LED is red or no LED is showing and the display indicates 1 or 2 chevrons, the Digistat+2RF will need to be re-positioned until the LED changes to amber or green and 3 or 4 chevrons are indicated on the display.

NOTE:

If there is no LED and the display on the LPIORF shows '- - -', there is no signal being received at all from the Digistat+2RF. Transmission will resume once the Digistat+2RF is re-positioned in a part of the house where an amber or green LED and 3 or 4 chevrons are achieved.

- 10 Once you are happy that, when in the desired location, the Digistat+2RF is sending a good signal to the LPIORF i.e. amber or green and 3 or 4 chevrons, the Digistat+2RF can be fixed to the wall.

NOTE:

Continue on next page to cancel the signal strength mode.

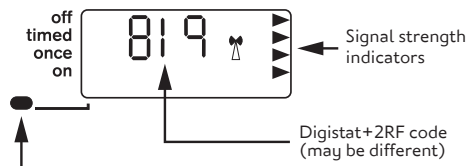

LED indicator shows different colour depending on signal strength (see table below)

LED Indication	Chevrons	RF Strength
Green	4	Very strong
Amber	3	Strong
Red	2	Weak
None	1	Very weak

To cancel signal strength mode:

- 1 Remove the batteries from the Digistat+2RF transmitter to cancel the constant transmission.
- 2 After a few seconds the LPIORF display will show '---'.



- 3 Press 'OK' on the LPIORF and the display will return to the time with the 'CH and Antenna' flashing.



- 4 Re-insert the batteries into the Digistat+2RF and the RF link will be re-established.

Positioning the Digistat +2RF room thermostat

The Digistat is a radio frequency device which is very flexible for positioning as there is no need for hard wiring to the appliance. The device should be mounted in an open area, no closer than 30cm from metal objects, including wall boxes.

Mount the Digistat+2RF on a wall which is not subject to direct sunlight or draughts, preferably on an inside wall, 1.5 metres above the floor. The Digistat+2RF must also not be directly influenced by radiators or other appliances giving off heat.

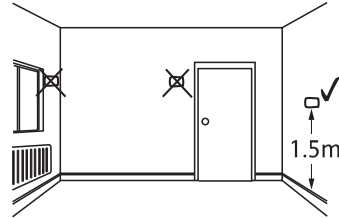

Mounting the Digistat+2RF room thermostat

- 1 Remove the front cover using a flat screwdriver and separate from back plate.

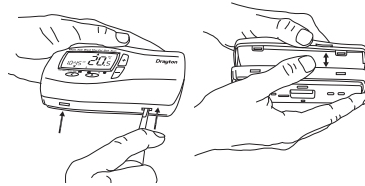

- 2 Fix the back plate directly onto the wall using the allocated fixing points and suitable wall plugs and screws.

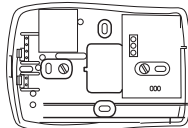

- 3 Replace the front cover by locating in position and pushing fully onto the back cover.



- 4 Remove the battery cover using a coin



- 5 Install the 2 AA batteries provided



- 6 Replace battery cover

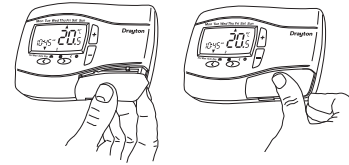

Signal Strength

To check signal strength on previously installed and paired units:

Follow either 1 OR 1a to 1c below

- 1 Press & hold the set? button for 10s and 'SSI and OFF' will be displayed.
OR
- 1a Press the set? button 4 times.
- 1b Press the OK button once.
- 1c Press the set? button 5 times; 'SSI and OFF' will be displayed.

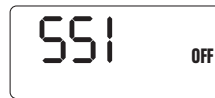

- 2 Press the '+' button so that the display shows 'SSI, Antenna and ON'.

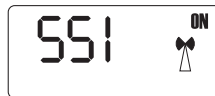

- 3 Press the 'set' button so the display shows 'SSI and Antenna'.

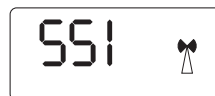

- 4 After a few seconds the display will show '---'.
- 5 Remove the batteries from the Digistat+2RF and wait until the display has faded away.
- 6 Press and hold the '+' button on the Digistat+2RF while re-inserting the batteries and keep the button depressed until the display shows 'rF'.

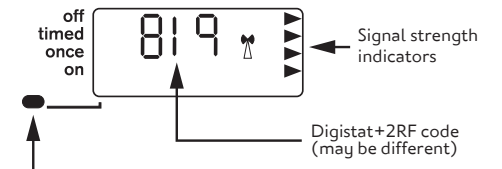
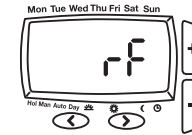

LED indicator shows different colour depending on signal strength (see table below)

LED Indication	Chevrons	RF Strength
Green	4	Very strong
Amber	3	Strong
Red	2	Weak
None	1	Very weak

To cancel signal strength mode:

- 1 Remove the batteries from the Digistat+2RF to cancel the constant transmission.
- 2 After a few seconds the LPIORF display will show '---'.
- 3 Press 'OK' on the LPIORF and the display will return to the time with the 'CH and Antenna' flashing.



- 4 Re-insert the batteries into the Digistat+2RF and the RF link will be re-established.

Installer Options

If you wish to change any of the Installer Options as shown in the table below, enter the Installer Option Menu from Auto mode by pressing: **◀** and **+** simultaneously for 5 seconds.

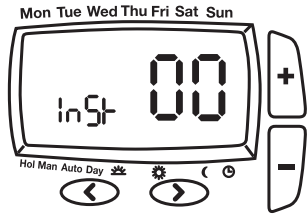

Pressing **◀** and **+** again for 5 seconds will exit the Menu and return to Auto mode.

Once the Installer Options screen has been selected, the **◀** and **▶** buttons allow you to scroll through the Menu (shown below). The **+** and **-** allow you to change values.

Once a value has been changed pressing **▶** before exiting the Menu will save the new setting. (The below display shows Option 02 OFF).

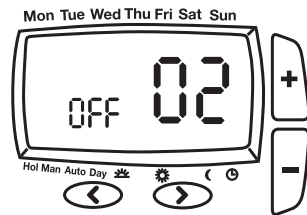

Installer Options	Function	Select Option	Default	
02	Freeze protection	On	Off	On
04	Low Set Point °C	5	High Limit	5
05	High Set Point °C	Low Limit	32	32
06	Delayed Start (Energy saving feature)	On	Off	Off
10	Valve protection	On	Off	Off
11	Valve protection time (Mins)	1	5	3
12	Application type	0	1	0
13	System Capability	0	1	0

Option 02 - Freeze Protection

Freeze protection will switch on the heating if the room temperature falls to 5°C and will then control the temperature at 7°C even if the Digistat is in OFF mode.

The Freeze Protection default is ON.

To switch off the Freeze Protection mode enter the Installer Options Menu (Refer to Installer Options 02) and change to OFF. Press **▶** to accept.

Option 04 & 05 - Low and High Limit set points.

The user temperature set points defaults are High 32°C and Low 5°C, to change these limits enter the Installer Options Menu (Refer to Installer Options 04 & 05).

Option 06 - Intelligent Delayed Start (Energy saving feature).

The Intelligent Delayed Start is an energy saving feature which automatically reduces the warm up time for the heating system.

If enabled, the start time should be set an hour earlier than the time you want the property to reach the set temperature.

Intelligent Start will delay that start time, by an amount that it has calculated based on the actual and set temperature.

As the weather becomes milder, the start time is delayed, so that fuel is not wasted bringing the room up to temperature earlier than necessary.

The Digistat calculates approximately 10 minutes to raise the temperature by 1°C, up to a maximum of 6°C.

NOTE:

Intelligent Delayed Start only applies in **Auto mode**. Intelligent Delayed Start default is in **OFF mode**. To switch ON Intelligent Delayed Start enter the Installer Options Menu (see Installer Options 06).

NOTE:

The Intelligent Delayed start option is not suitable for underfloor application. Ensure Installer option 06 is set to OFF before final commissioning for underfloor application.

SPECIAL NOTE:

If the Intelligent delayed start feature is enabled, (Off changed to On in Installer option 06), please inform the end user of this feature.

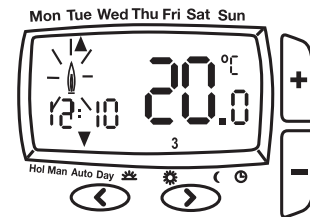

The following special note has been added to the user instruction to explain the adjustment requirement:

When the delay period is operating indicated by the flame symbol flashing, pressing any button returns the Digistat to auto mode allowing normal button operation until the next time/ temperature event, when it will resume the delay start mode or follows the Holiday, Manual, Override or Off modes as selected.

Changes to the installer options and pre-set programmes must be made with the flame symbol not flashing.

Option 10 - Valve Protection

In some heating systems there may be a requirement to protect the system by operating it once a day, for a given period.

If valve protection is selected the system will be operated for a period as shown in valve protection time (mins).

Valve protection time is every day at 10.00am. Valve protection default is OFF.

To enable the valve protection mode enter the Installer Options Menu (Refer to Installer Option 10).

Option 11 - Valve Protection time (mins).

Valve protection time can be set between 1 and 5 minutes (default 3 minutes).

To change this once a day on time enter the Installer Options Menu (Refer to Installer Option 11).

Option 12 - Application Type

Digistat+2RF can be used for different applications. In the installer menu, select:
00 = Gas Boiler
01 = Oil Boiler

Option 13- System Capability

Adjust this setting to suit the heating system capability. In the installer menu, select:
00 = Fast – the house usually reaches setpoint in < 1 hour
01 = Slow – the house usually reaches setpoint in > 1 hour

Display Error code EI

When the display shows an error code (EI) this indicates a sensor fault and the heating system will remain Off. Please contact your local heating service engineer to replace your Digistat +2RF.



User Guide

LPI0RF & DIGISTAT+2RF

DIGISTAT+2RF Room Thermostat

What is a programmable room thermostat?

...an explanation for householders

A programmable room thermostat is both a programmer and a room thermostat. A programmer allows you to set 'On' and 'Off' time periods to suit your own lifestyle.

A room thermostat works by sensing the air temperature, switching on the heating when the air temperature falls below the thermostat setting, and switching it off once this set temperature has been reached.

So, a programmable room thermostat lets you choose what times you want the heating to be on, and what temperature it should reach while it is on. It will allow you to select different temperatures in your home at different times of the day (and days of the week) to meet your particular needs.

Turning a programmable room thermostat to a higher setting will not make the room heat up any faster. How quickly the room heats up depends on the design of the heating system, for example, the size of boiler and radiators.

Neither does the setting affect how quickly the room cools down. Turning a programmable room thermostat to a lower setting will result in the room being controlled at a lower temperature, and saves energy.

The way to set and use your programmable room thermostat is to find the lowest temperature settings that you are comfortable with at the different times you have chosen, and then leave it alone to do its job. The best way to do this is to set low temperatures first, say 18°C, and then turn them up by one degree each day until you are comfortable with the temperatures. You won't have to adjust the thermostat further. Any adjustments above these settings will waste energy and cost you more money.

If your heating system is a boiler with radiators, there will usually be only one programmable room thermostat to control the whole house. But you can have different temperatures in individual rooms by installing thermostatic radiator valves (TRVs) on individual radiators. If you don't have TRVs, you should choose a temperature that is reasonable for the whole house. If you do have TRVs, you can choose a slightly higher setting to make sure that even the coldest room is comfortable, then prevent any overheating in other rooms by adjusting the TRVs.

The time on the programmer must be correct. Some types have to be adjusted in spring and autumn at the changes between Greenwich Mean Time and British Summer Time.

You may be able to temporarily adjust the heating programme, for example, 'Override', 'Advance' or 'Boost'. These are explained in the manufacturer's instructions.

Programmable room thermostats need a free flow of air to sense the temperature, so they must not be covered by curtains or blocked by furniture. Nearby electric fires, televisions, wall or table lamps may prevent the thermostat from working properly.

Your Digistat +2RF

The Digistat +2RF thermostat is a programmable thermostat 24-Hour product (the same program for every day of the week) which allows you to set up to 6 time and temperature events per day.

Clock Setting

Your Digistat +2RF is fitted with a real-time clock, which is pre-set at the factory. You will not have to alter the time settings. A special feature of this real-time clock is to automatically update the time during the summer/winter time change removing the need to manually alter the clock.

General Operation

With the unit in Auto mode (the small arrow to bottom of screen will point to Auto) the temperature can be changed for a short time by using the + or - buttons. Changing the temperature in this way will keep the Digistat +2RF set to your new temperature until the next pre-programmed event (at which time it will revert to programmed temperature). The temperature you are setting will flash on the screen. Once temperature is set, the unit will revert to showing the current temperature.

The  indicator will show on the screen if the heating is turned on.

A flashing flame  indicates the product is in intelligent delayed start mode.

Controls and Display Layout

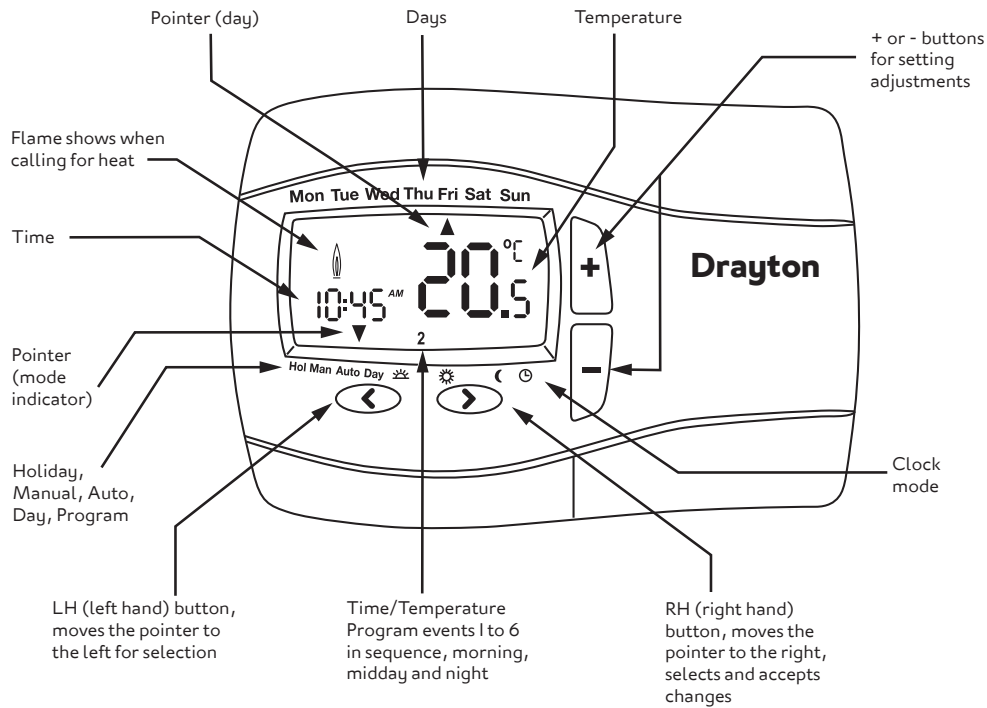

NOTE:
Temperature displayed is actual room temperature unless adjusting the + or - button when it displays the set temperature. Once adjustment is complete and after 5 seconds this will return to actual room temperature.

Basic Settings

The Digistat +2RF thermostat is a programmable thermostat 24-Hour (the same program for every day of the week) and allows you to set 6 time and temperature events per day.

Digistat +2RF Pre-set Program

Your Digistat +2RF comes with the following default settings pre-programmed for your convenience:

Pre-set Program I (9 til 5)

Event	1	2	3	4	5	6
Time	6:30	8:30	12:00	14:00	16:30	22:30
Temp	20.0	16.0	16.0	16.0	21.0	7.0

NOTE:
The above settings can be understood using the chart below

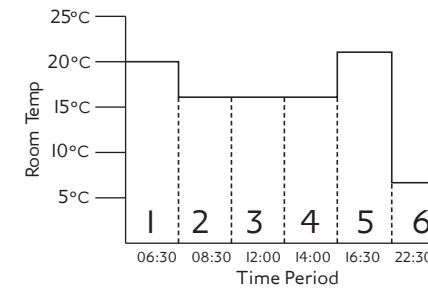

As you can see, at 06:30, the heating will come on to raise the temperature to 20°C. At 08:30, the temperature set point is dropped from 20°C down to 16°C, it stays at 16°C throughout the day, until 16:30 when the temperature increases to 21°C. The temperature then drops down to a night-setback temperature of 7°C until 06:30 when the cycle repeats for the next day.

To adjust these times and temperatures

- With the product operating as normal in the Auto mode press twice until the display is flashing as shown. The time will be flashing, use the + or - buttons to adjust the 1st time as required.

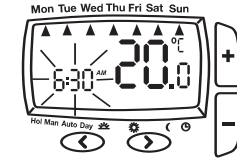

- Once the time has been set press to confirm and use the + or - button to adjust required temperature (temperature shown required flashing).

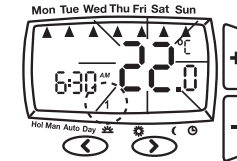

NOTE:
The small I in the lower half of the screen shows which time period is being set e.g. 1=1st period, 2=2nd period, etc.

- Once the temperature has been set press to confirm and move to the next time and temperature periods to be adjusted confirming changes by pressing button. (max 6 periods).

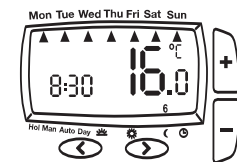

- To exit press or until you return to auto mode with the bottom chevron pointing to auto (as shown).

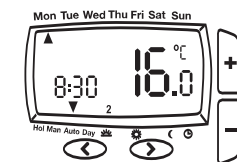

To change temperature for a short period (Override)

- 1 Press + or - buttons to adjust set temperature. Set temperature shown flashing.

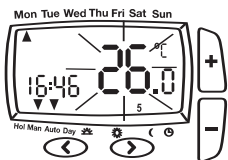

- 2 After 5 seconds the Digistat+2RF will start controlling at the selected setpoint but the display shows the actual room temperature. 2 chevrons indicates override mode.

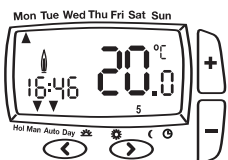

- 3 To exit override press > once or wait until next change in the pre-set program.

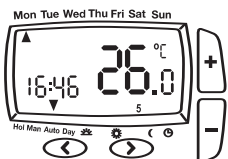

To set a constant room temperature (Manual mode)

- 1 Press < once, the display shows temperature flashing (example 20.0°C).

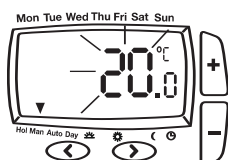

- 2 Press + or - buttons to adjust the temperature as required. The temperature will stop flashing after 5 seconds and start controlling at this temperature.

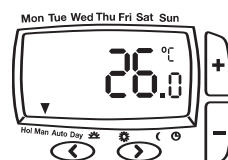

- 3 To exit manual mode press > once, to return to auto.

To set holiday mode:

- 1 Press < twice, the display shows time flashing. Time periods between 1 to 23(Hr) hours and 1 to 199(d) days can be set.

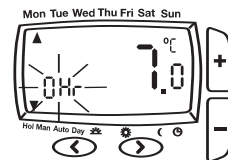

- 2 Press + or - buttons to adjust the count down time as required. Press > once to confirm, the display will show temperature flashing.

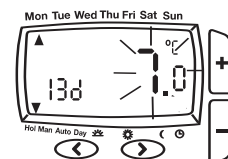

- 3 Press + or - buttons to adjust temperature and press > to start holiday count down time. Alternatively after 10 seconds the temperature will stop flashing and holiday count down time will start. Display shows count down time and ambient room temperature.

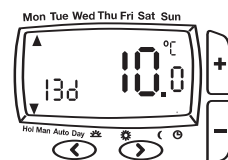

- 4 To exit the holiday mode press < or > once, to return to auto.

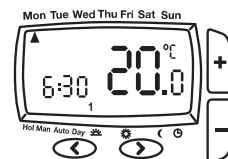

To switch OFF the thermostat:

Press the + and - simultaneously for 5 seconds until the OFF is displayed.

The thermostat and heating system will now be OFF unless the temperature in the controlled space falls below 7°C, the frost protection set point. Please note this does not affect the operation of the domestic hot water where provided.

To switch ON the thermostat, press any key to return to auto mode.

User Options

If you wish to change any User Options (shown in table on next page) they can be accessed from Auto or Man by pressing < and > simultaneously for 3 seconds. Once you have accessed the User Options Menu (Fig 1) press > to scroll through selectable options. The settings for each option can be changed by pressing + or - as required. Press > to accept the change and move to the next option. To exit press < and > simultaneously for 3 seconds. Alternatively, not pressing any buttons for 2 mins will cause the Digistat +2RF to return to Auto. (Fig 2) shows option 01 24 (24 hour clock).

Only selected options that have been accepted by pressing > will be changed.

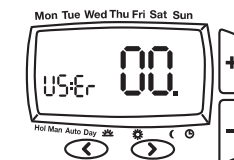

Fig 1

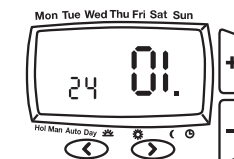

Fig 2

User Options	What is it	Min	Max	Default
01	Change 12h or 24h clock	12	24	24
02	Change to another pre-set programme	1	3	1
03	Change the number of programme events per day	2, 4 or 6		6
04	Switch on/off automatic summer/winter time change	On	Off	On
05	Adjust date and time	Factory Set		
06	Change temperature offset °C	-5	5	0
07	Restore pre-set programme	On	Off	Off
08	To disable Off function	On	Off	On
09	Access protection lock	On	Off	Off

Option 01 - How to change from 24hr to 12hr clock

Enter user options, select option 01 and use + and - keys to select desired option, 12 = 12hr and 24 = 24hr. Press to accept change.

Option 02 - How to change to another pre defined program 1, 2 or 3

Enter user options, select option 02 and use + and - keys to select desired program 1, 2 or 3. 1 = program 1, 2 = program 2 and 3 = program 3. Press to accept desired change.

Pre-set Programs 2 and 3 are shown below:

Pre-set Program 2 (Home for Lunch)

Event	1	2	3	4	5	6
Time	6:30	8:30	12:00	14:00	16:30	22:30
Temp	21.0	16.0	21.0	16.0	21.0	10.0

NOTE:
The above settings can be understood using the chart to the right.

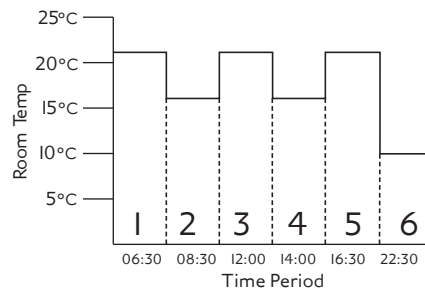

As you can see, at 06:30, the heating will come on to raise the temperature to 21°C.

At 08:30, the temperature set point is dropped to 16°C, it stays at 16°C until 12:00 when the heating comes on to raise the temperature to 21°C. The temperature stays at 21°C until 14:00 when it drops to 16°C. At 16:30, the heating comes on to raise the temperature to 21°C where it stays until 22:30, when the temperature drops down to a setback temperature of 10°C until 06:30, when the cycle repeats the next day.

Pre-set Program 3 (Home Worker)

Event	1	2	3	4	5	6
Time	6:00	8:30	12:00	14:00	17:30	22:30
Temp	21.0	19.0	21.0	19.0	21.0	16.0

NOTE:
The above settings can be understood using the chart below.

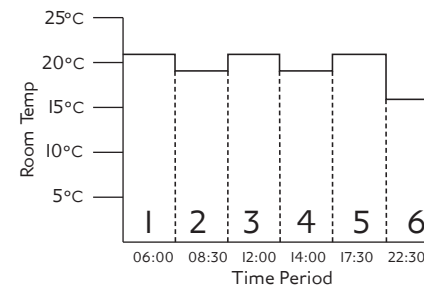

As you can see, at 06:00, the heating will come on to raise the temperature to 21°C.

At 08:30, the temperature set point is dropped to 19°C, it stays at 19°C until 12:00 when the heating comes on to raise the temperature to 21°C. The temperature stays at 21°C until 14:00 when it drops to 19°C. At 17:30, the heating comes on to raise the temperature to 21°C where it stays until 22:30, when the temperature drops down to a setback temperature of 16°C until 06:00, when the cycle repeats the next day.

Option 03 - How to change the number of program events per day

Enter user options, select option 03 and use + and - keys to select desired option. 2 = 2 time / temp events per day, 4 = 4 time / temp events per day and 6 = 6 time / temp events per day. Press to accept desired change.

Option 04 - How to switch on/off the automatic summer / winter time change

Twice a year the actual time is automatically changed to keep it in line with the summer / winter time change. Default setting is On. If you wish to disable / enable this feature enter user options, select option 04 and press - or + key to display Off or On as desired. Press to accept desired change.

NOTE:
Date and time setting.
Digistat +2RF comes with a pre-set clock, which also automatically adjusts for summer/winter time changes. It is activated automatically on 1st installation. There should be no need to change these settings, however, should you wish to, it can be done in Option 05.

Option 05 - How to adjust date and time

Enter user options, select option 05 (Fig 3) To change the year press once (fig 4) To change the month press again (fig 5) To change the day press again (fig 6) To change the time press again (fig 7) Once you have selected your required display, to adjust press + or - and to accept change.

To select option 06 press until option 06 display is shown (fig 8)

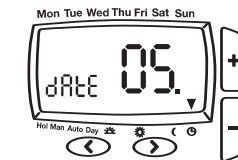

Fig 3

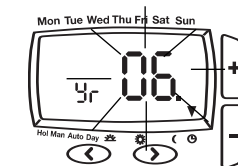

Fig 4

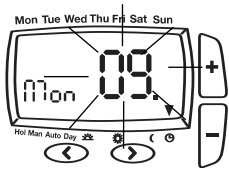

Fig 5

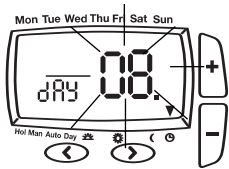

Fig 6

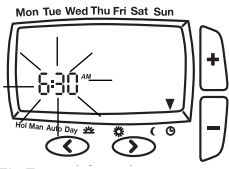

Fig 7

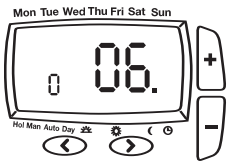

Fig 8

Option 06 - How to change temperature offset

The temperature displayed on the thermostat may not match that of other temperature measuring devices in the controlled space, because of its location. The displayed temperature may be offset to bring it in line with other devices. To adjust the temperature, enter the user options, select option 06. The temperature may be offset by +/- 5 degrees by pressing the + and - keys. Press to accept the desired change.

Option 07 - How to restore the built in time temperature programs

Enter user options, select option 07 and use + and - keys to select desired option. Off = current programs retained. On = restore factory program settings. Press to select the desired change. The Option 07 display automatically reverts back to OFF. Please note enabling this function will lose any user changes to the preset programs.

Option 08 - How to disable the OFF function

To disable the OFF function, enter user options, select option 08 and use + or - keys to select Off. Press to accept change. It is now not possible to switch the Digistat+2RF OFF using the + and - keys as previously described. To enable the OFF function return to option 08 and select ON. Press to accept change.

Option 09 - How to lock the key pad - Access Protection Lock

The access protection lock allows you to lock the Digistat +2RF so that it cannot have any adjustments. The default is OFF mode allowing you to adjust the Digistat +2RF. To Lock the Digistat +2RF settings enter the User Options Menu Option 09 and select On and press to accept. Once the User Options Menu is exited all buttons will be locked. To switch off the Protection Lock enter the User Menu and change to OFF. Press to accept. Once the User Menu is exited all buttons will be free to adjust.

★ SPECIAL NOTE:

The following only applies when the Intelligent delayed start feature is enabled by the installer.

When the delay period is operating indicated by the flame symbol flashing (Fig 9), pressing any button returns the Digistat +2RF to auto mode allowing normal button operation until the next time/ temperature event, when it will resume the delay start mode or follows the Holiday, Manual, Override or Off modes as selected.

Changes to the installer options and pre-set programmes must be made with the flame symbol not flashing.

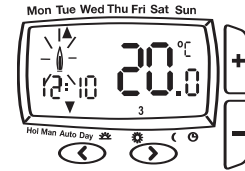

Fig 9

What is Intelligent delayed start?

Intelligent Delayed Start (Energy saving feature)

The Intelligent Delayed Start is an energy saving feature which automatically reduces the warm up time for the heating system. As the weather becomes milder, Intelligent Start will delay the heating start times so that the fuel is not wasted bringing the room up to temperature earlier than necessary.

Battery Change

How do I know when to change the batteries.

When the batteries start to run low a battery icon will flash in the display, to indicate "low battery" during this time the Digistat will function normally.

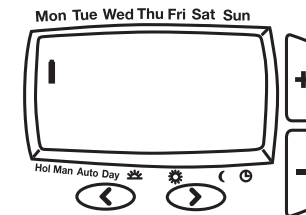
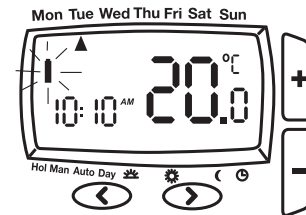

Replace with 2 x 1.5V (AA) Alkaline batteries.

When the battery icon alone is shown in the display, the batteries are completely exhausted and the Digistat will cease to function. Re-activate by replacing the batteries **The RF link will automatically be re-established.**

How to replace the batteries

Remove the battery cover using a coin. Replace the spent batteries with 2 x 1.5V (AA) Alkaline batteries ensuring correct orientation. Replace the battery cover pressing fully home.

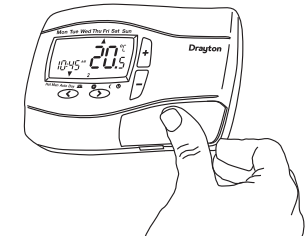
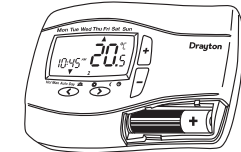
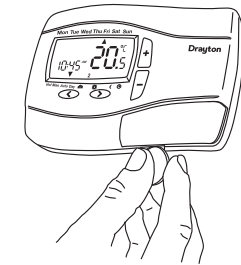

LPIORF Programmer & Receiver

If the engineer has set your program and timings – you do not need to do anything else. Just keep this guide in a safe place for future reference.

Introduction

The programmer will automatically switch your hot water on and off at times that suit you.

The green light on the front of the programmer shows when it is on. LPIORF has a 7-day program allowing for different timings on each day of the week, for up to 3 heating periods each day.

If the engineer hasn't set your timings for you, your programmer will work with a standard program that has been set at the factory. If this doesn't suit you, it's very easy to change it.

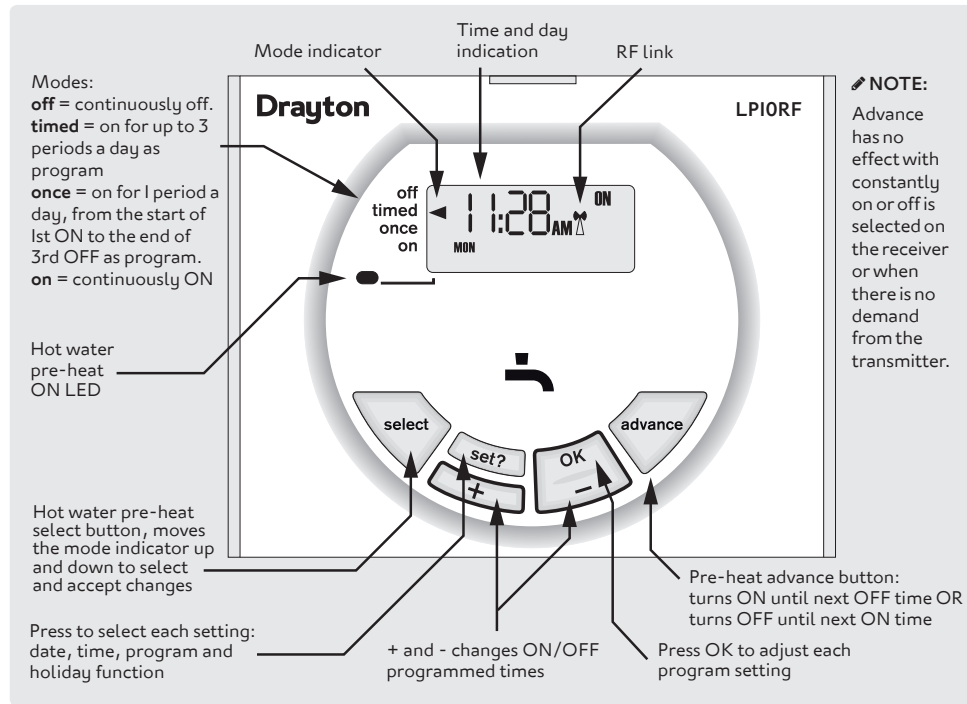

Normal Operation

During normal operation the receiver will flash the red LED, approximately every five minutes. This indicates that a radio signal is being received from the Digistat transmitter.

Radio Signal Loss

If the red LED does not flash approximately every five minutes then the receiver will show a flashing green LED together with the flashing antenna symbol and the Central Heating indicator arrow will point to OFF. This situation indicates that the radio signal link from the

Digistat transmitter has been lost. This may be remedied by fitting new batteries in the Digistat transmitter. If fitting new batteries does not restore the link, then temporarily move the Digistat transmitter close to the appliance, if this does not restore the link, then technical help must be sought to remedy the failed radio signal link.

Temporary Override

While the RF link is lost, the Central Heating can be switched ON by pressing the OK button once and switched OFF by pressing the OK button again. In this mode the room temperature will not be controlled.

The Standard Program

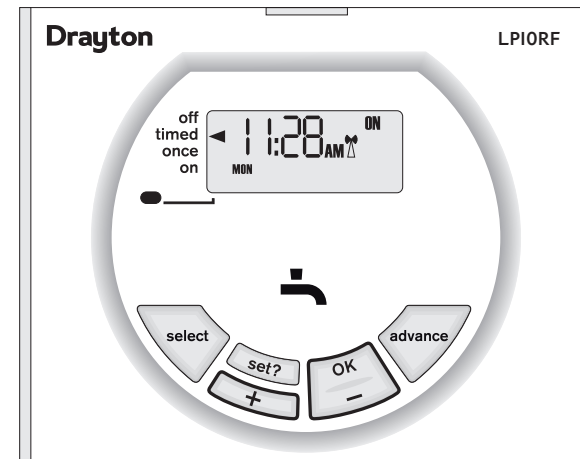

NOTE:

The ON/OFF periods pre-programmed for Hot Water pre-heat are shown in the table opposite. The factory installed settings can be used without any further programming of the receiver. The date and time are pre-programmed and should not require adjustment.

NOTE:

Two ON/OFF periods can be used instead of three, by setting the second ON/OFF periods to 12:00 as shown in the default program table.

If you need to restore the factory pre-set program times then:

Press the + and - buttons together, for three seconds or longer, to restore the default program times to those shown in the table opposite.

One ON/OFF period can be achieved by setting the second and third ON/OFF periods to the same time.

See **Changing the Program** on the next page, if changes are required to the clock time or pre-programmed settings.

Switching	Weekdays	Weekends
	HW	HW
1st ON - start of first timed period	6.30am	7.00am
1st OFF - end of first timed period	8.30am	9.00am
2nd ON - start of second timed period	12.00pm	12.00pm
2nd OFF - end of second timed period	12.00pm	12.00pm
3rd ON - start of third timed period	4.30pm	4.00pm
3rd OFF - final switch-off of the day	10.30pm	11.00pm

Changing the Program

Setting MON - FRI

- 1 Press **set?** until SET and PROG? are shown in the display.



- 2 Press **OK** to enter program.
- 3 Press **OK** to select MON-FRI.



NOTE:
Speed up the display by holding down the + or - buttons.

- 4 Press + or - to change the ON time.



- 5 Press **set?** to set the ON time and select the OFF time.



- 6 Press + or - to change the OFF time.
- 7 Press **set?** to set the OFF time and select the next ON time.

Repeat operations 4 to 7 to set the second and third ON/OFF times.

NOTE:
After pressing **set?** for the third hot water pre-heat OFF time the display shows SET MON

Setting individual weekdays:

NOTE:
If you do not require individual weekday times, then press **set?** until SET SAT-SUN are displayed and continue on the next page. If you do not wish to change the setting for the day displayed, then press **set?** until the first day you want to change is displayed.

- 1 Press **OK** to select weekday.



- 2 Press **OK** to select first ON time.

NOTE:
Speed up the display by holding down the + or - buttons.

- 3 Press + or - to change the ON time.



- 4 Press **set?** to set the ON time and select the OFF time.



- 5 Press + or - to change the OFF time.
- 6 Press **set?** to set the OFF time and select the next ON time.

Repeat operations 3 to 6 to set the second and third ON/OFF times.

NOTE:
After pressing **set?** for the third OFF time, SET and the next weekday are displayed after completing the steps above for FRI the display shows SET SAT-SUN. see next page....

Setting SAT - SUN:

- 1 Press **OK** to select weekend.



NOTE:
Speed up the display by holding down the + or - buttons.

- 2 Press + or - to change the ON time.



- 3 Press **set?** to set the ON time and select the OFF time.



- 4 Press + or - to change the OFF time.
- 5 Press **set?** to set the OFF time and select the next ON time.

Repeat operations 3 to 6 to set the second and third ON/OFF times.

NOTE:
After pressing **set?** for the third OFF time, SET SAT are displayed. If you do not require individual weekend times, then press **set?** until the normal display is resumed.

Setting individual weekend days:

NOTE:
If you do not require individual weekend day times, then press **set?** until the normal display is shown.

If you do not wish to change the settings for SAT, then press **set?** to move to SUN.



Setting individual weekend days:

- 1 Press **OK** to select the day displayed.
- 2 Press + or - to change the ON time.



- 3 Press **set?** to set the ON time and select the OFF time.



- 4 Press + or - to change the OFF time.
- 5 Press **set?** to set the OFF time and select the next ON time.

Repeat operations 3 to 6 to set the second and third ON/OFF times.

NOTE:
After pressing **set?** for the third hot water pre-heat off time for SAT, the display will show SET SUN. Press **OK** to set SUN or press **set?** until the display returns to normal mode.

Setting holidays:

- 1 Press the **set?** button until SET and HDAY? are displayed.



- 2 Press OK and the display shows 00.



- 3 Press + or - to set the number of days you require the system to be off.



- 4 Press **set?** then HDAY is shown in the display and no demand for heating will be made from the programmer. The program will return to normal after the set number of days. To cancel the holiday setting and return to normal operation, press any button.



NOTE:

The programmer counts each pass through midnight as a day. e.g. if you do not want heating from Saturday morning until Tuesday morning, set for three days.

Setting the clock and time

- 1 Press the **set?** button until SET and CLOCK? are shown in the display.



- 2 Press OK to display 24hr and ON.



- 3 Press + to switch between 24hr and 12hr display.

- 4 Decide between 24 hour or 12 hour display and press **set?** to select, now the hours will flash.

- 5 Press + or - to set the correct hour.



NOTE:

Speed up the display by holding down the + or - buttons.

- 6 When the correct hour has been selected, press **set?** to select, now the minutes will flash.



- 7 Press + or - to set the correct minutes.

- 8 When the correct minutes have been set, press **set?** to select that setting.
 - Now SET and DATE will be displayed.
 - If the day and date needs resetting, refer to the next page for SETTING THE DATE.
 - If the day and date are correct, press **set?** to return to the normal display.



Setting the date:

- 1 Press the **set?** button until SET and DATE? are displayed.



- 2 Press the OK button once, the year flashes on the display.



- 3 Press + or - to set the correct year, e.g. 04.



- 4 When the correct year has been chosen, press **set?** to select, now the month will flash.



- 5 Press + or - to select the correct month, e.g. 08.

- 6 When the correct month has been chosen, press **set?** to select, now the day will flash.



- 7 Press + or - to select the correct day, e.g. 16.

- 8 When the correct day has been chosen, press **set?** to select, now dLS will be displayed and ON will flash.

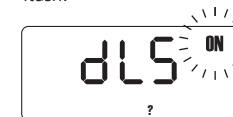

- 9 Press + or - to switch between ON or OFF. If you choose ON then the clock will automatically adjust the time for Daylight saving. If you choose OFF then the time will not change to take account of the Daylight Saving time change twice a year.

- 10 Press **set?** twice to return to the normal display.



NOTE:

dLS = Day Light Savings time

Maintenance

The Digistat+2RF requires no maintenance.

The outer casing can be wiped clean using a dry cloth. DO NOT use polish or detergents.

These units can not be serviced.

Should the existing units fail to function correctly, check that the:

- LPIORF Receiver times and program settings are correct.
- RF signal link is set up (Refer to page 2 for RF signal range details).
- Digistat +2RF Room thermostat batteries are the correct type, fitted correctly and are not exhausted. Fit new batteries if in doubt.

Digistat+2RF Thermostat
part number 22090

LPIORF Programmer & Receiver
part number 22589DR