

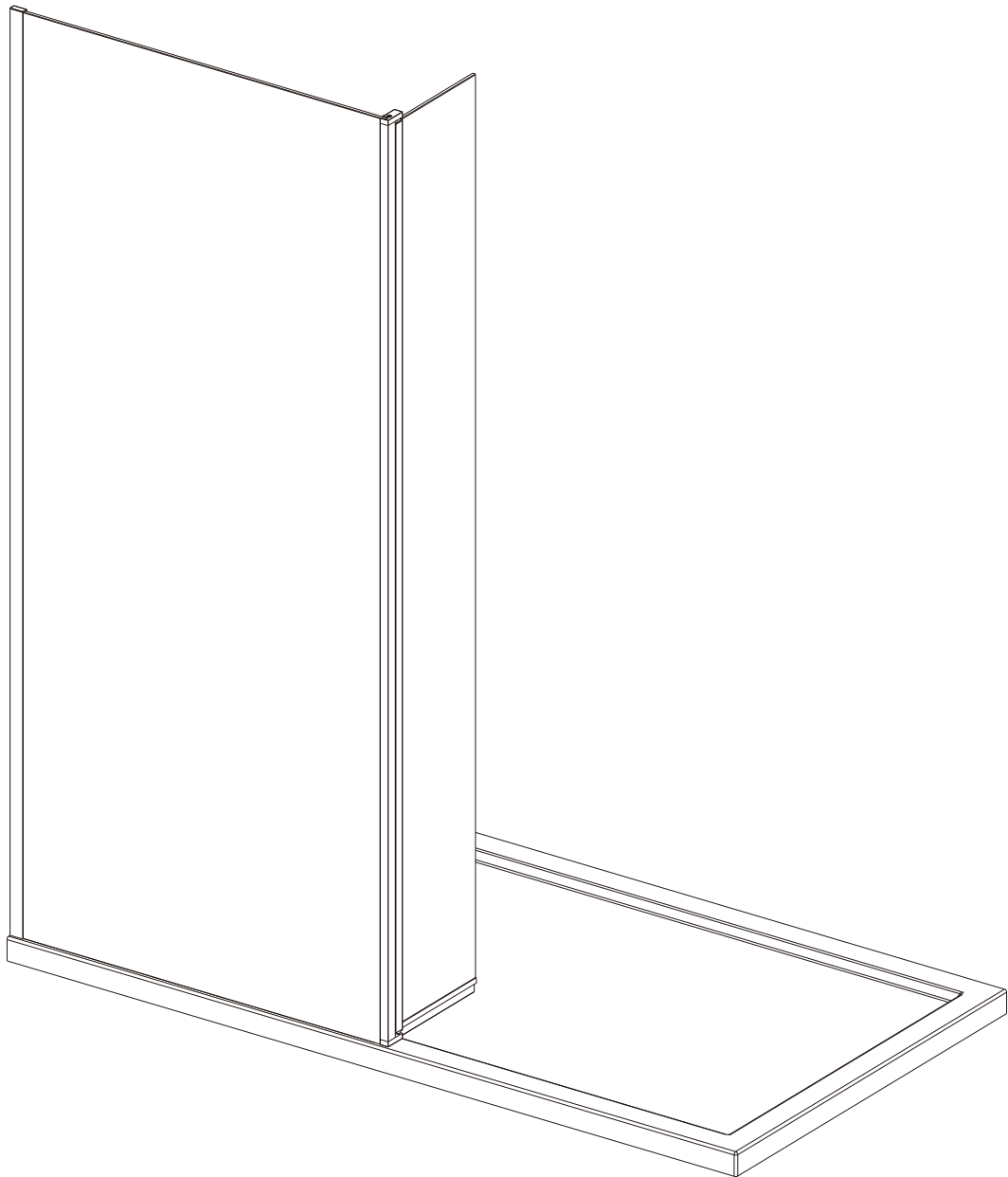







# 8MM WET ROOM FLIPPER PANEL

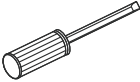
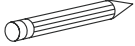
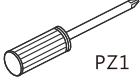
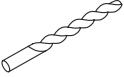
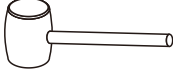
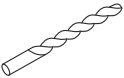

## General Information

Please inspect this product upon delivery. Any missing parts or manufacturing defects must be reported immediately to the supplier. Damage or defects reported later will not be accepted. TAKE CARE WHEN HANDLING GLASS PARTS-AVOID HEAVY CONTACT BETWEEN THE GLASS EDGES AND ANY HARD SURFACE. Glass breakage claims will not be accepted after the product has been unpacked.

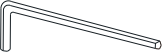
## TOOLS REQUIRED

DESCRIPTION	PART IMAGE	DESCRIPTION	PART IMAGE
Tape measure		Drill	
Spirit level		Flat-head Screwdriver	
Pencil		Cross head Screwdriver	 PZ1
Ø6mm Drill bit		Mallet	
Ø3mm Drill bit		Silicone Sealant	
Ø3mm Hexagon Wrench		Ø2mm Hexagon Wrench	

 This product is heavy and may require two people to install.

## ASSEMBLY INSTRUCTIONS - DRAWING

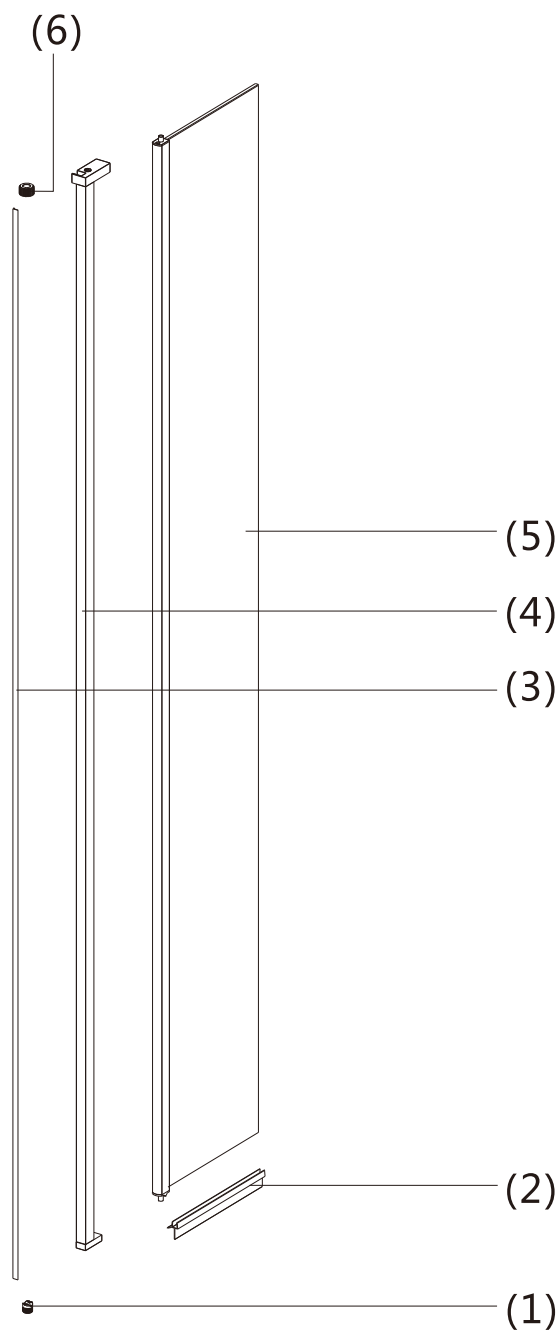

- (1) 1x Bottom Pivot Core
- (2) 1x Bottom Seal
- (3) 1x Wedge Gasket Seal B
- (4) 1x Corner Post
- (5) 1x Flipper Panel
- (6) 1x Top Pivot Core

# STEP 1 CHECK LEFT HAND OR RIGHT HAND FITTING

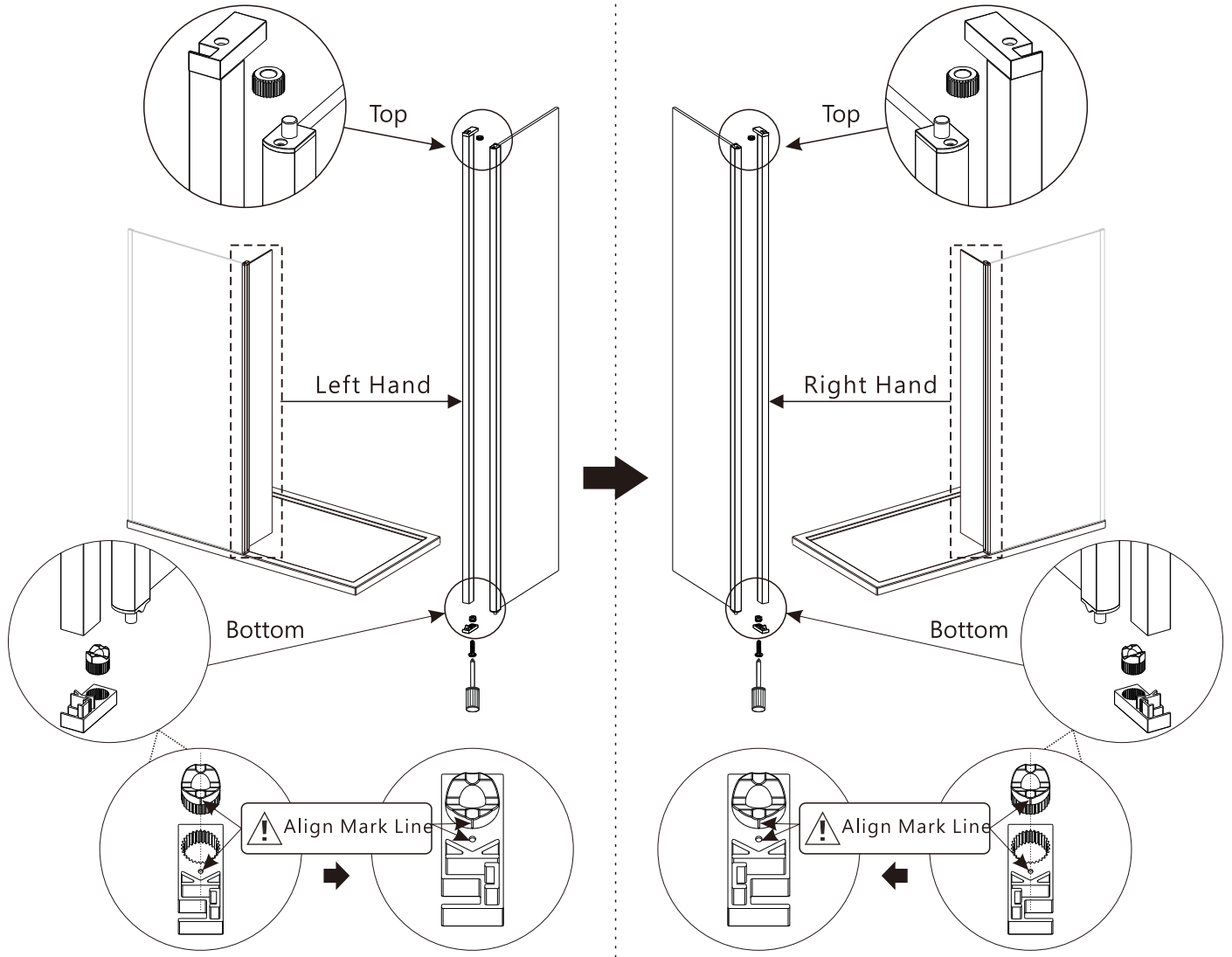

# STEP 2 FITTING THE SEALS AND TOP CAP

