

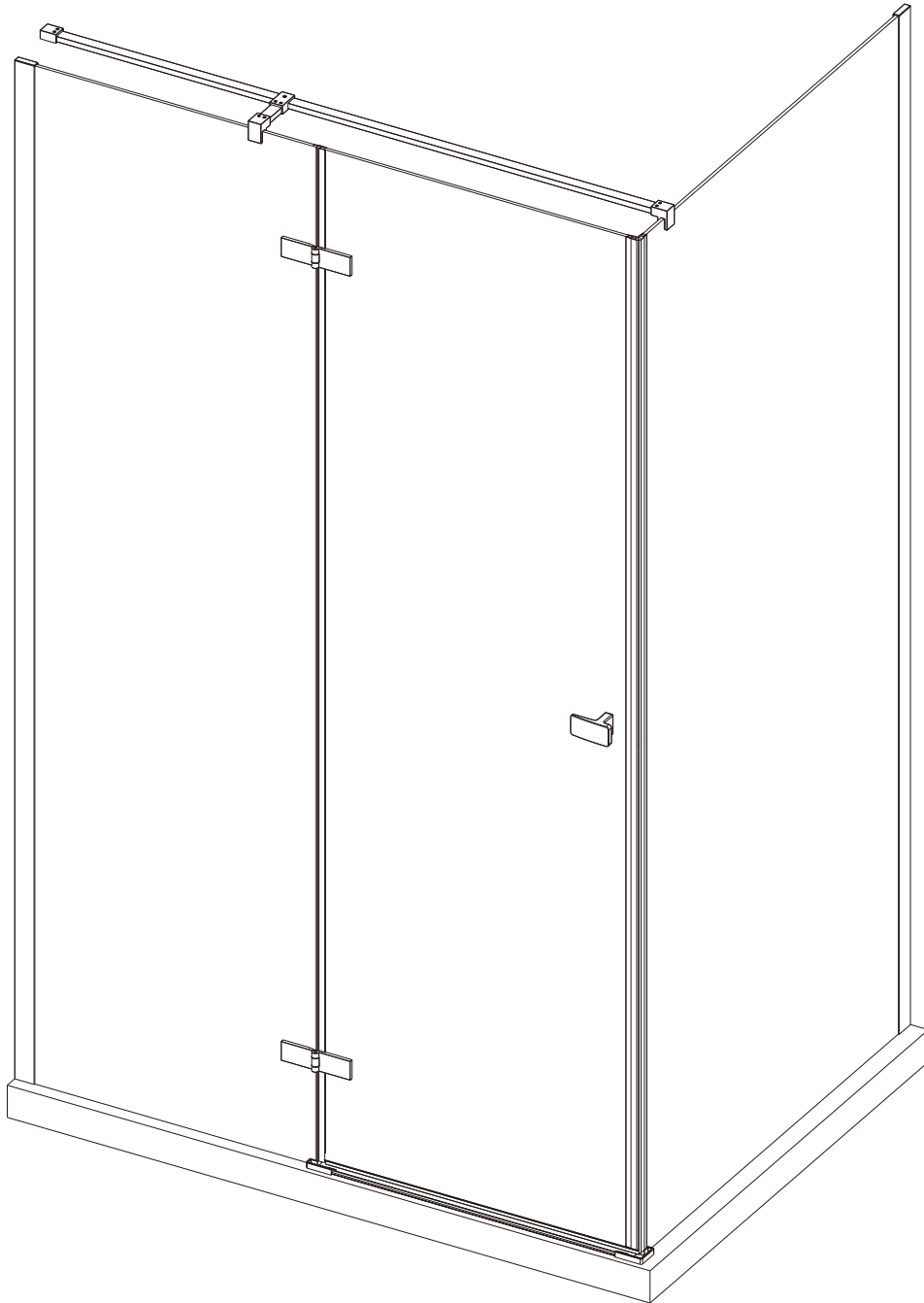







# 6mm FRAMELESS HINGE DOOR SIDE PANEL

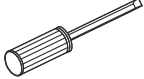
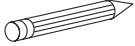
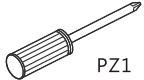
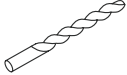
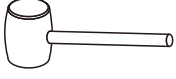

## General Information

Please inspect this product upon delivery. Any missing parts or manufacturing defects must be reported immediately to the supplier. Damage or defects reported later will not be accepted. TAKE CARE WHEN HANDLING GLASS PARTS-AVOID HEAVY CONTACT BETWEEN THE GLASS EDGES AND ANY HARD SURFACE. Glass breakage claims will not be accepted after the product has been unpacked.

## TOOLS REQUIRED

DESCRIPTION	PART IMAGE	DESCRIPTION	PART IMAGE
Tape measure		Drill	
Spirit level		Flat-head Screwdriver	
Pencil		Cross head Screwdriver	
Ø6mm Drill bit		Mallet	
Ø3mm Drill bit		Silicone Sealant	
Ø4 Allen Key		Ø2 Allen Key	

 This product is heavy and may require two people to install.

# ASSEMBLY INSTRUCTIONS - DRAWING

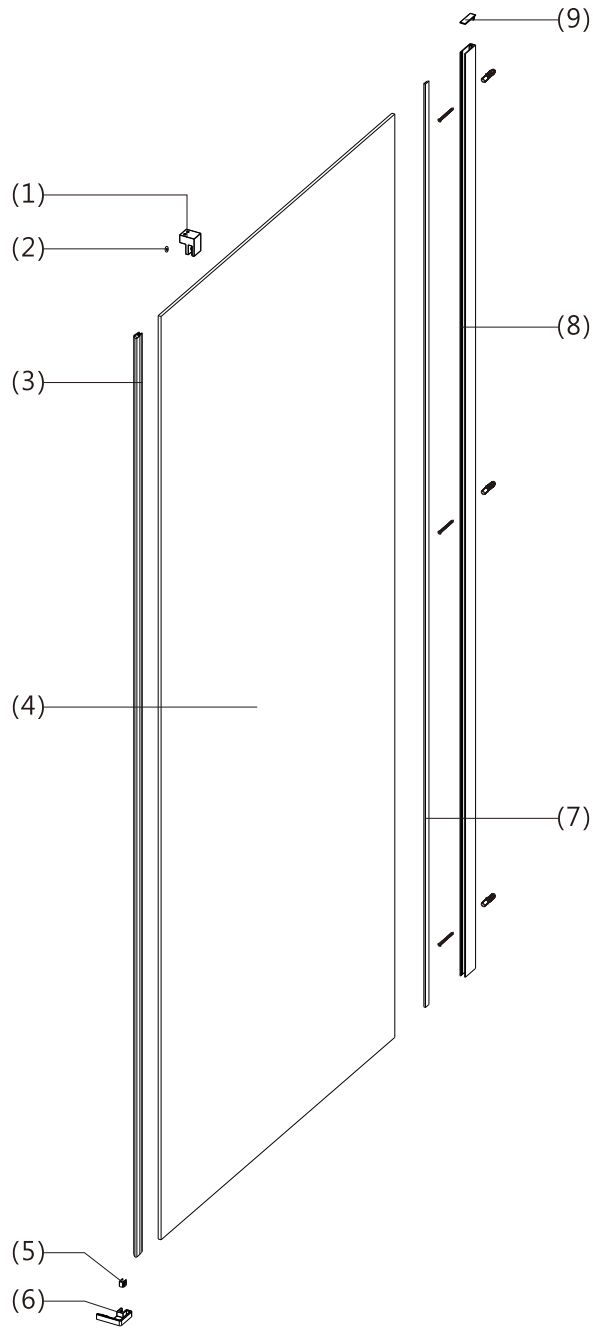

- (1) 1x Glass Clamp
- (2) 1x Glass Clamp Cover Cap
- (3) 1x Magnetic Seal
- (4) 1x Side Panel
- (5) 1x Glass Clip
- (6) 2x Drip Strip End Cap L&R
- (7) 1x Wedge Gasket Seal
- (8) 1x Wall Profile
- (9) 1x Wall Profile Cover Cap

# STEP 1

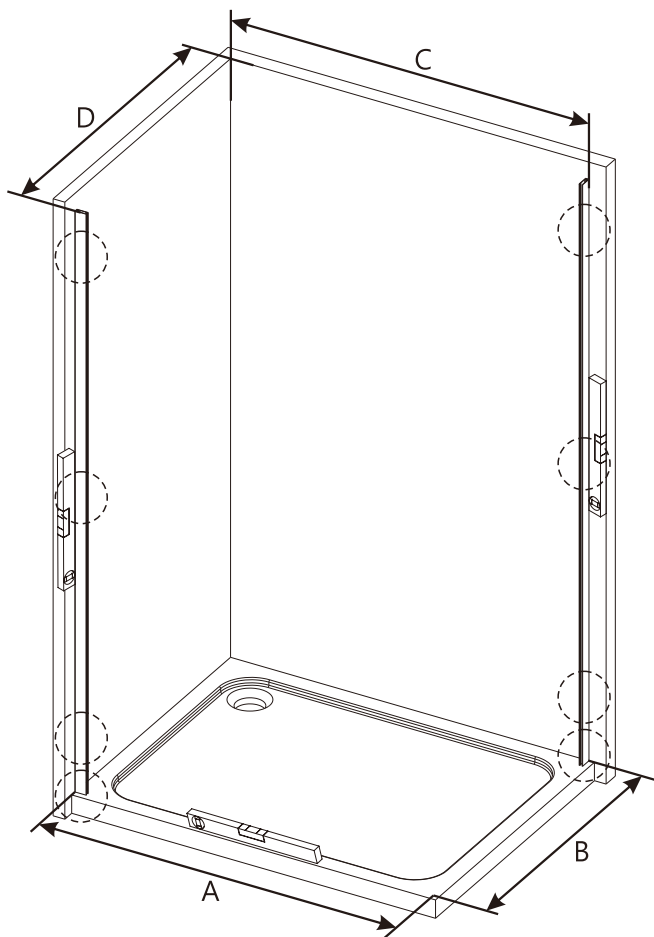

A	B	C	D
765-785	670-690	750-770	655-675
865-885	730-750	850-870	715-735
965-985	770-790	950-970	755-775
1165-1185	870-890	1150-1170	855-875

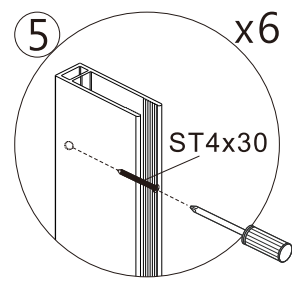
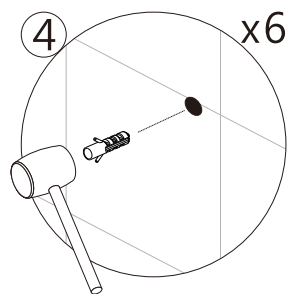
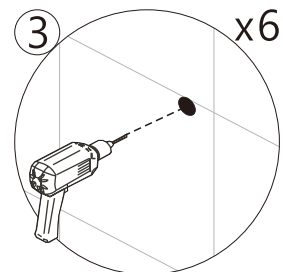
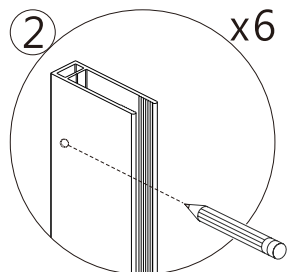

# STEP 2

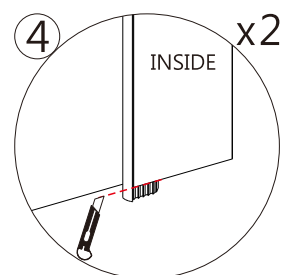
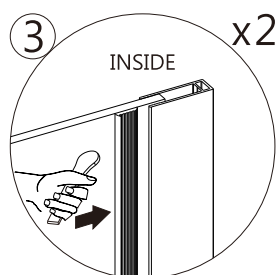
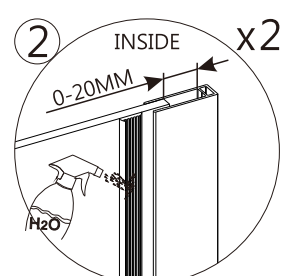
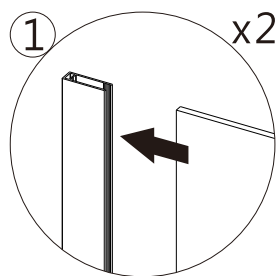
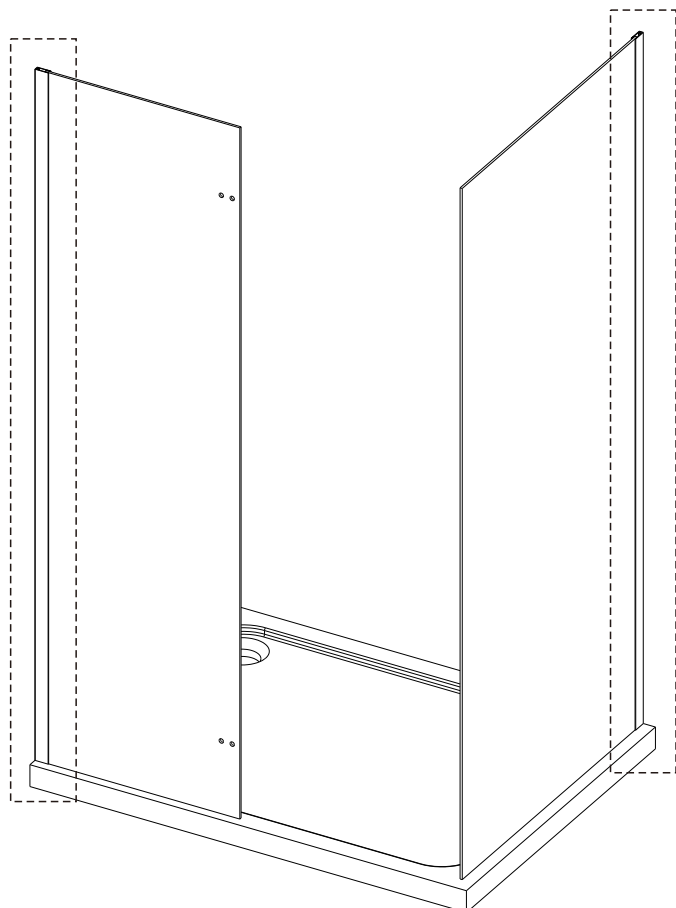

### STEP 3

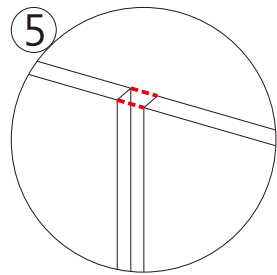
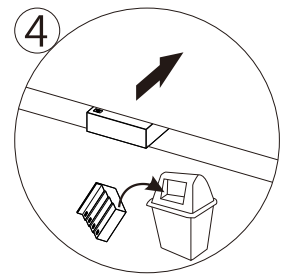
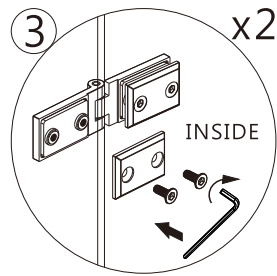
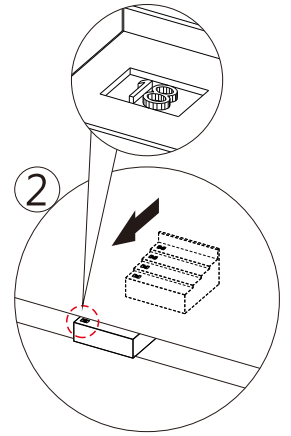
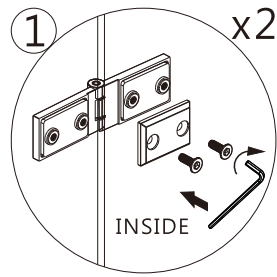
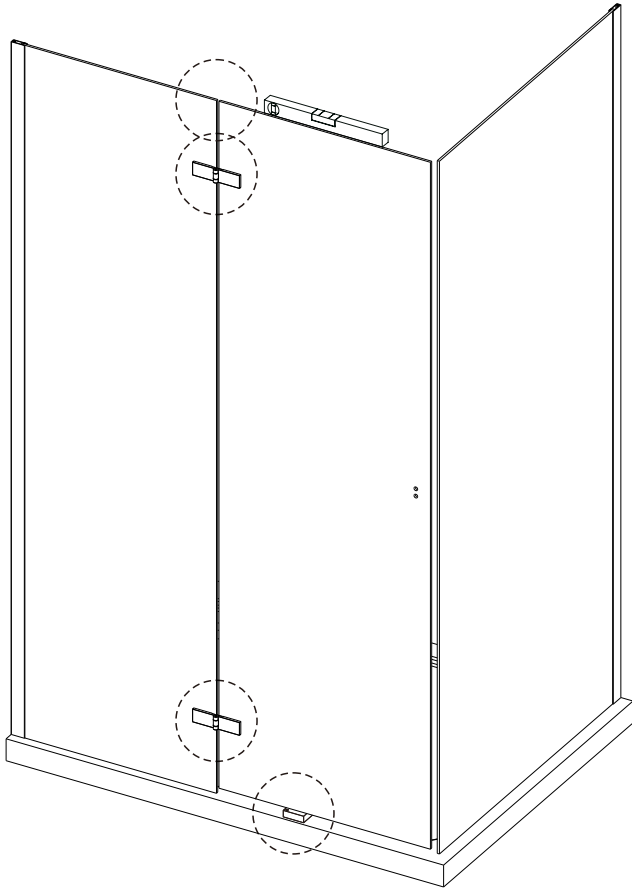

Note: After take off the support block , need person to hold the glass panel to keep not drop.

### STEP 4

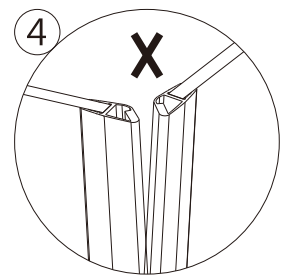
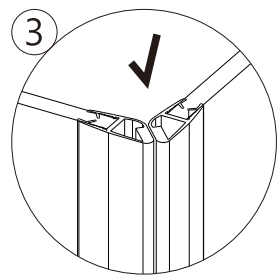
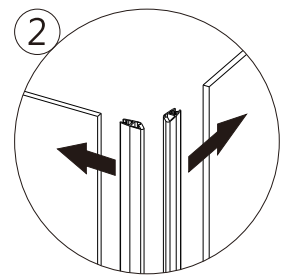
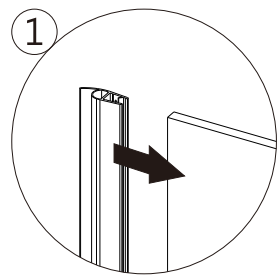
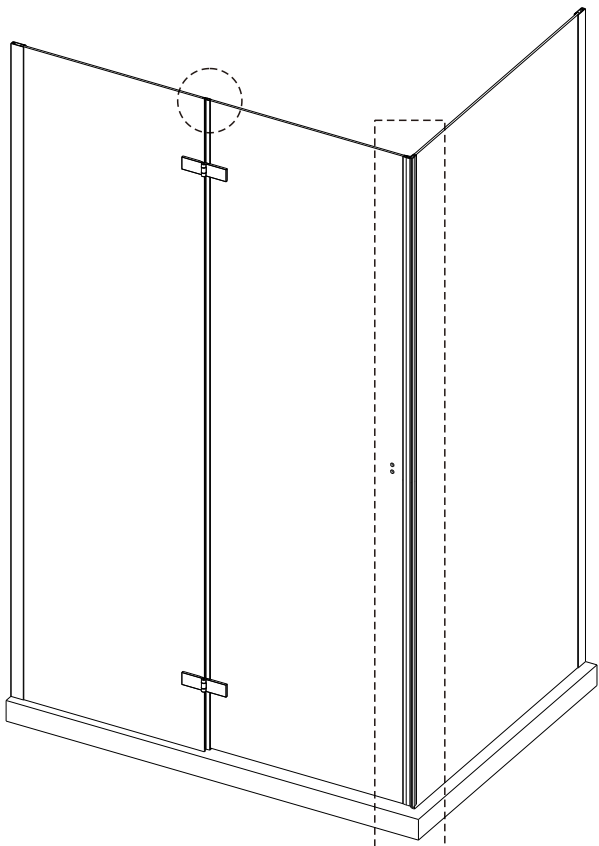

# STEP 5

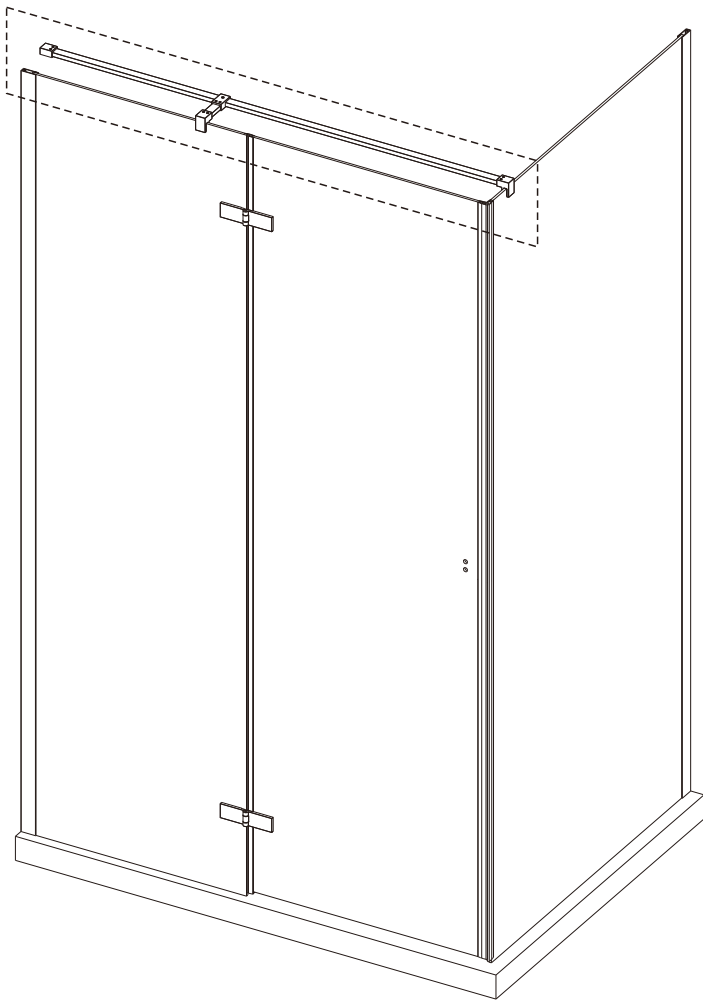

Product Side	L
1200*1900	1125-1145
1000*1900	925-945
900*1900	825-845
800*1900	725-745

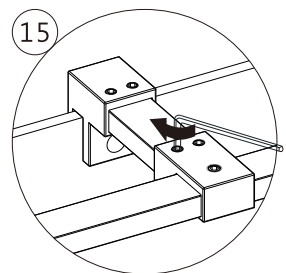
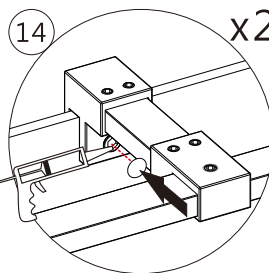
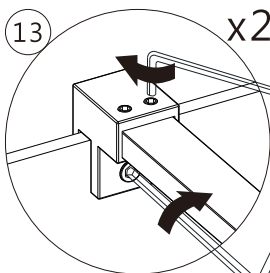
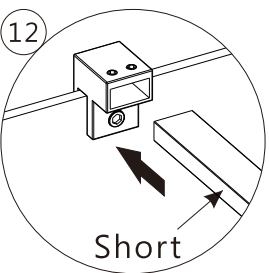
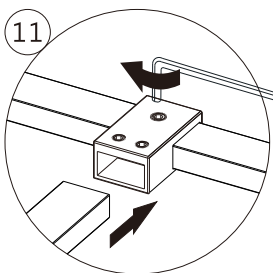
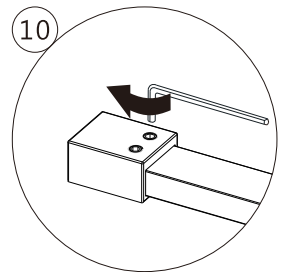
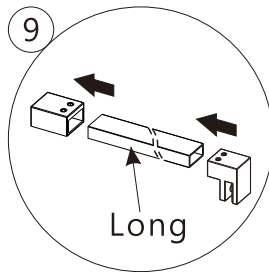
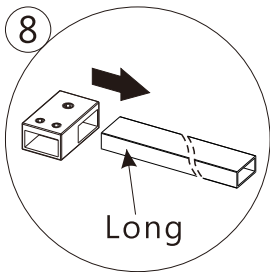
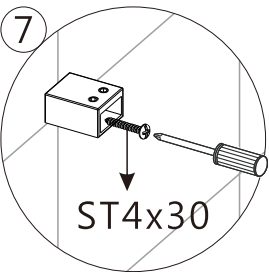
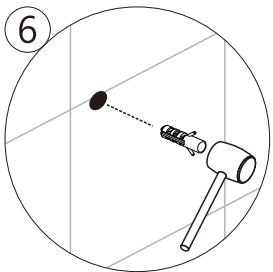
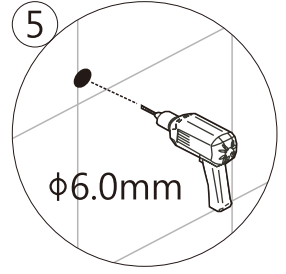
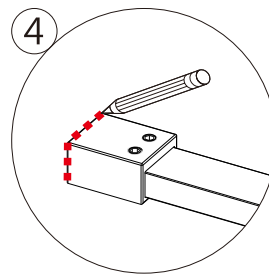
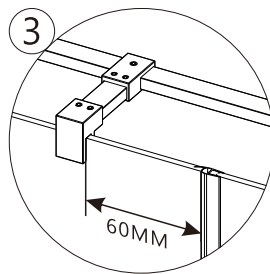
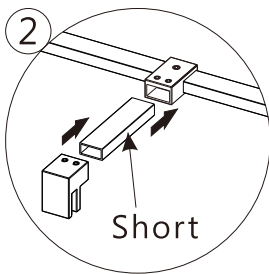
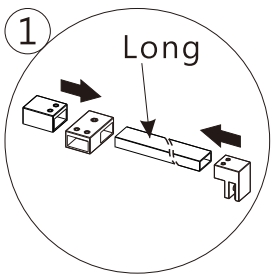
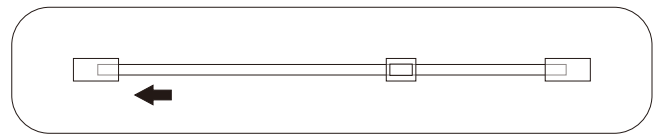
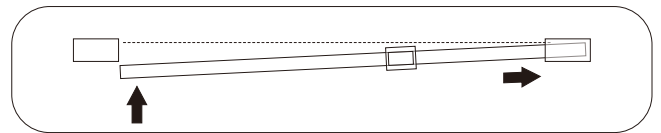
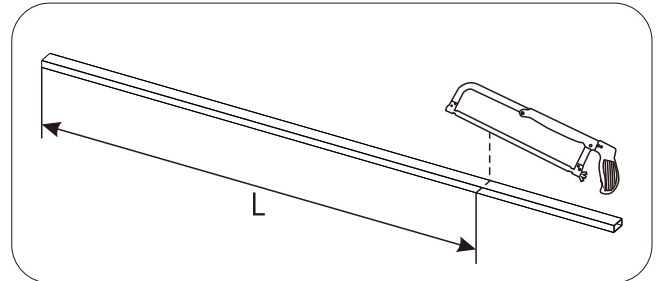

## STEP 6

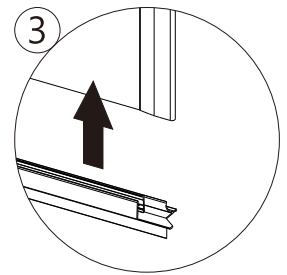
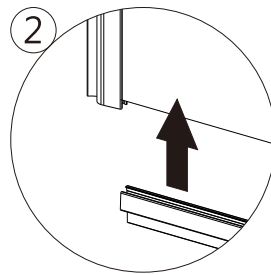
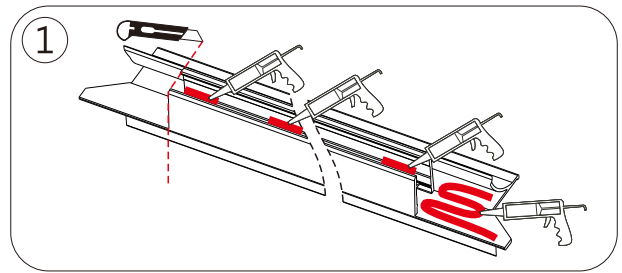
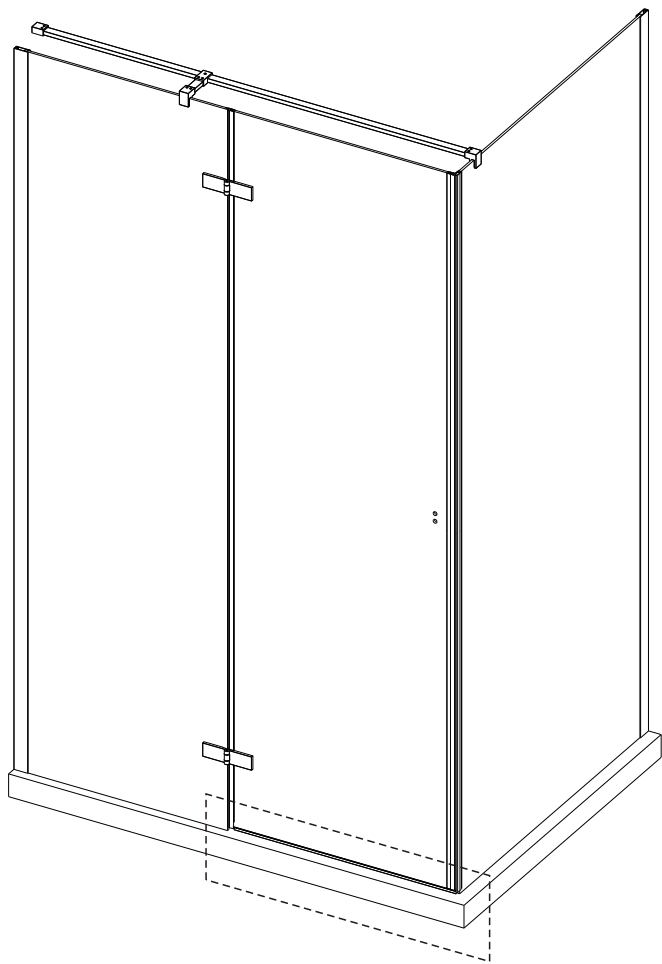

## STEP 7

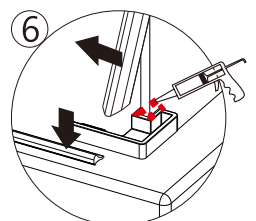
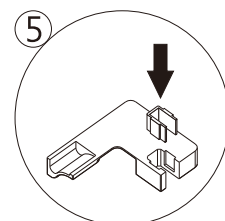
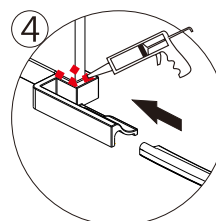
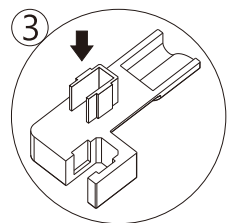
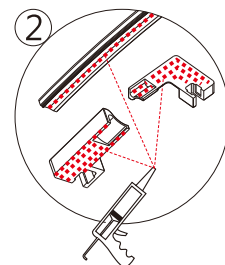
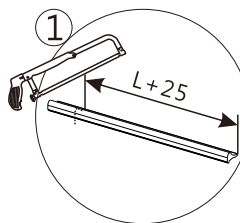
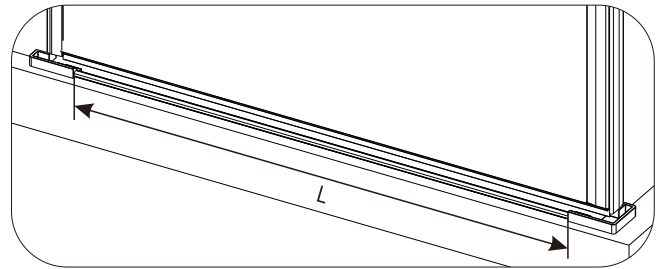
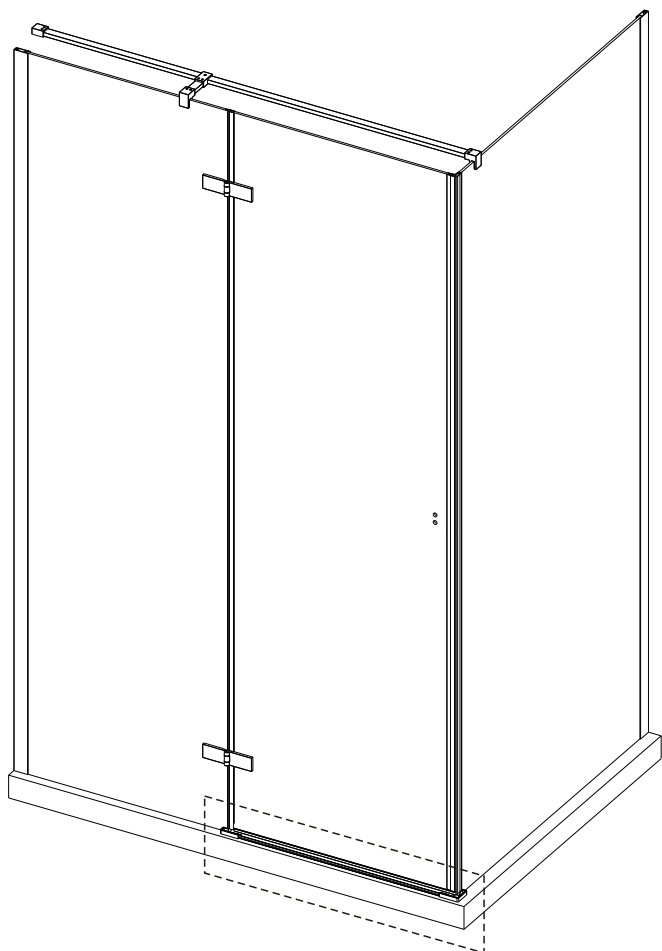

## STEP 10

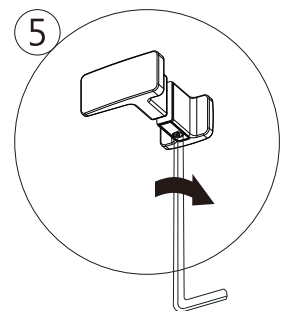
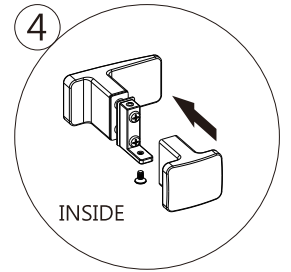
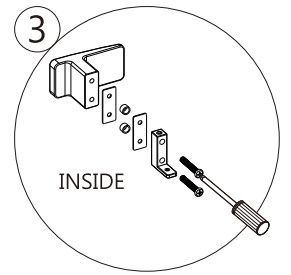
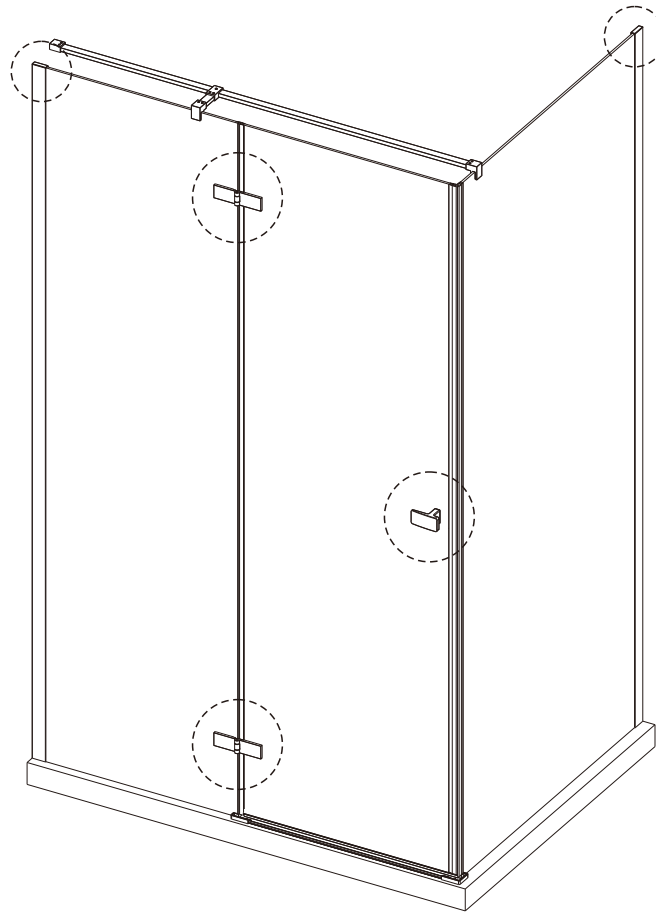
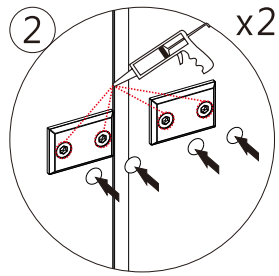
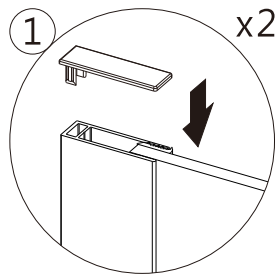

## STEP 11

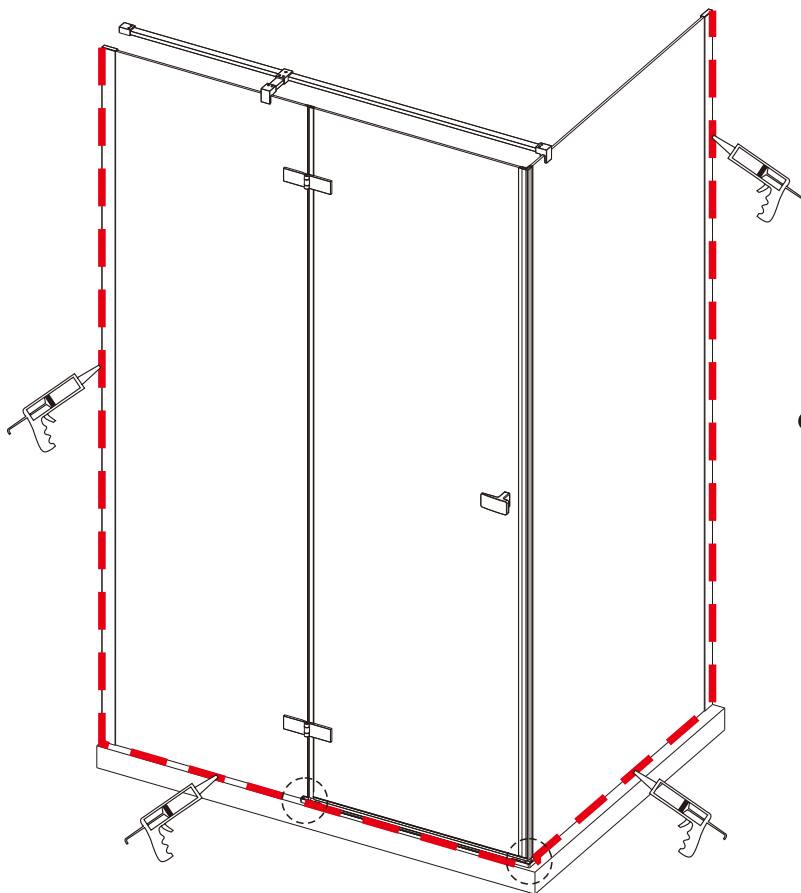

**Allow 24 hours for silicone to dry before use. Silicone on the outside edge only, NOT THE INSIDE**

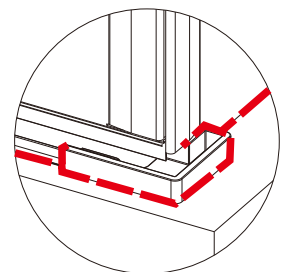
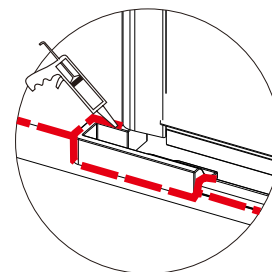

### Aftercare instructions

Regularly clean your shower product with warm soapy water to prevent lime scale build up. **DO NOT** use abrasive cleaning fluids or materials, or strong chemical cleaners as this will damage the product surface.