

J 1/2 C

JAVA Tap Range

Java Basin
Pillar Taps Chrome



Features:

- Long life and easy to use 1/4 turn ceramic disc valves
- Metal back nuts for added durability
- Easy-to-use lever handles

Product Certifications:



WRAS Certificate No: 2106904
WRAS Expiry Date: 30/06/2026



For more products, visit our website:
<http://www.bristan.com>



Specification

Product Type:	Bathroom Taps
Main Construction Material:	Brass
Mount Type:	Deck
Handle Type:	Lever
Connection Inlet:	1/2" BSP
Connection Outlet:	M24 Flow Straightener
Number of Tap Holes:	2
Valve/Cartridge Type:	1/2" Ceramic Disc Valve - 1/4 turn
Plumbing System Requirements:	Suitable for all plumbing systems
Minimum Dynamic Pressure (bar):	0.2 bar
Maximum Dynamic Pressure (bar):	5 bar
Maximum Hot Water Temperature °C:	65°C
Maximum Static Pressure (bar):	10 bar
Isolation Included:	No

Dimensions (measurements in mm)

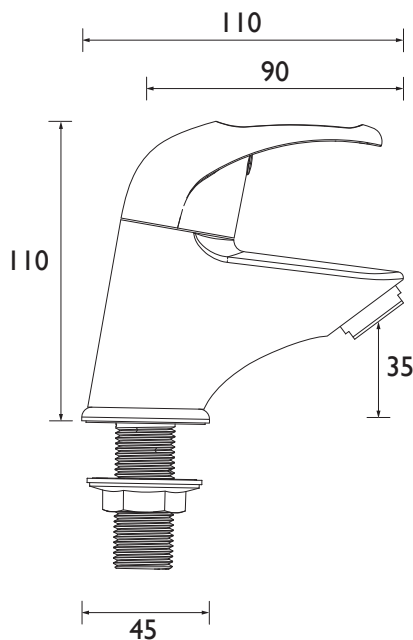

Flow Rates (l/min)

System Pressure (bar)	0.2	0.5	1	2	3	5
J 1/2 C (Cold)	9	14.2	20	28.3	34.7	44.8
J 1/2 C (Hot)	9	14.2	20	28.3	34.7	44.8

TECHNICAL
DATA
SHEET



BRISTAN

D11