



# BRISTAN

## Installation Instructions & User Guide

Please leave these instructions with the end user

Product Code: AL ES TBAS Range (D2)

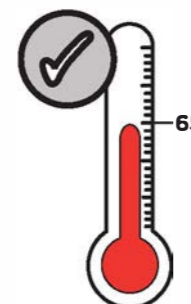
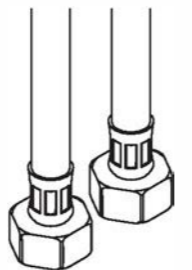
### Specification

<b>Dynamic Water Pressure</b> Min: 0.5 bar    Max: 5.0 bar  Maximum Static Pressure: 10.0 bar	<b>Inlet Water Temperature</b>  Maximum Hot: 65°C	<b>Inlet Connections</b>  1/2" BSP Flexible Tails	<b>Outlet</b>  M18.5 5/16 inch Coin-Slot Aerator
---	--	---	---

### Pack Contents

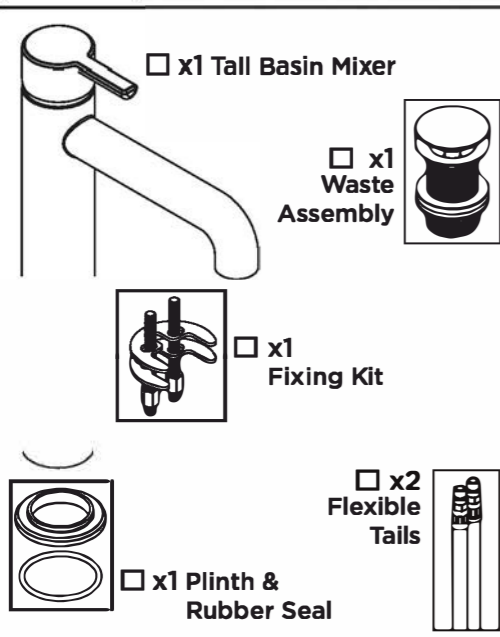

### Operation

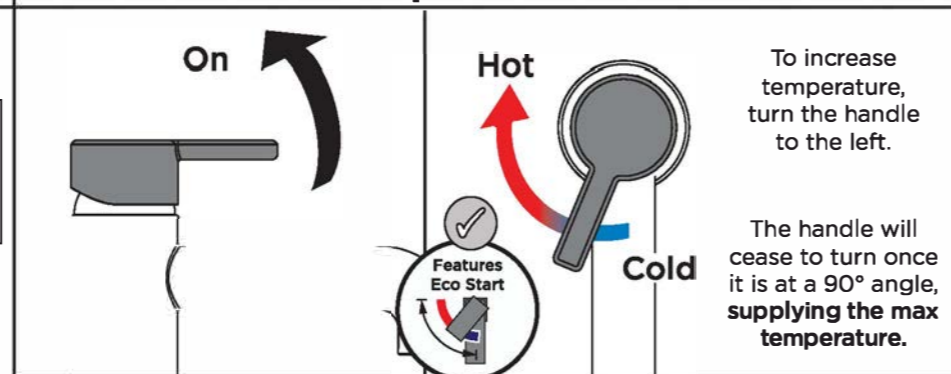

### Tools Required

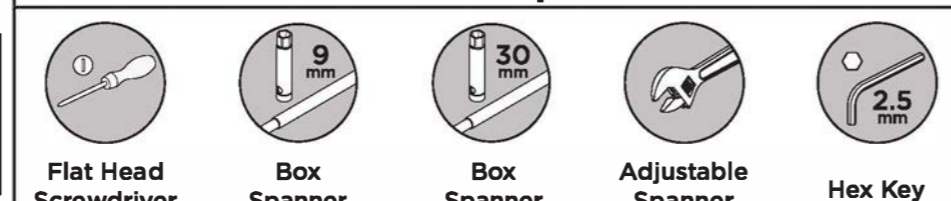

### Prior to Installation

All products manufactured and supplied by Bristan are safe to use provided that they are installed, operated and receive regular maintenance in accordance with these instructions.

This product needs to be installed in accordance with, and meet the requirements of The Water Supply (Water Fittings) Regulations (Northern Ireland) 2009 and The Water Supply (Water Fittings) (Scotland) Byelaws 2014. For full Installation Requirements & Notes (IRN) please visit [www.wrasapprovals.co.uk/approvals-directory](http://www.wrasapprovals.co.uk/approvals-directory)

Isolation valves must be fitted to the inlet water supplies to ensure ease of future maintenance.

Before installing this product the water supply must be thoroughly flushed in order to remove any swarf, solder etc. Full access must be made available for future maintenance/servicing purposes.

This product must not be modified in any way as this will invalidate the guarantee.

PLEASE NOTE - Taps shown in these instructions are for illustration purposes only. Your product can be installed and maintained using these instructions.

### Installation

**1**

Screw in the fixing kit rods into the base of the tap and tighten with a screwdriver.

Screw in the flexible tails by hand only. **DO NOT OVERTIGHTEN**

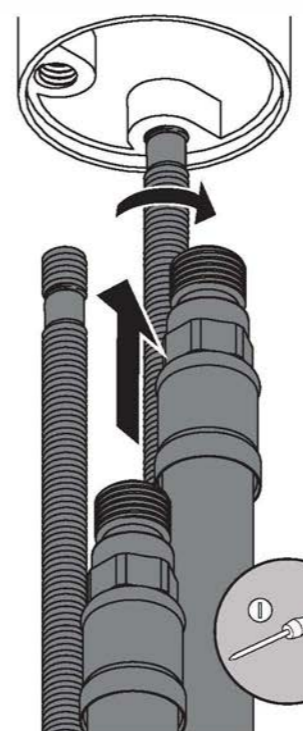

**2**

Thread the tap and tails through the plinth ensuring the rubber seal is in place.

Continue to thread through the tap hole.

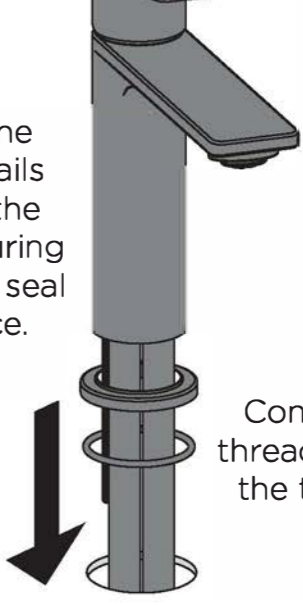

**3**

Slide the rubber gasket and metal clamp along the fixing rods as shown.

Align the gasket and clamp with each other and tighten nuts to secure.

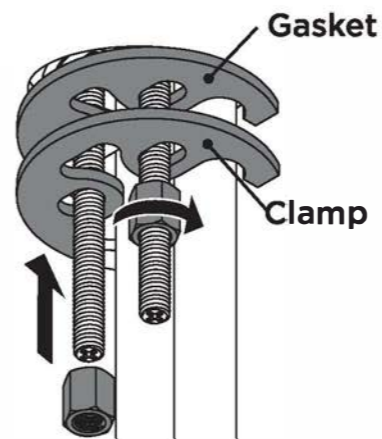

**4**

Connect the hot and cold water supplies to the flexible tails and turn until tight.

Refer to diagram below for correct flexible tail position.

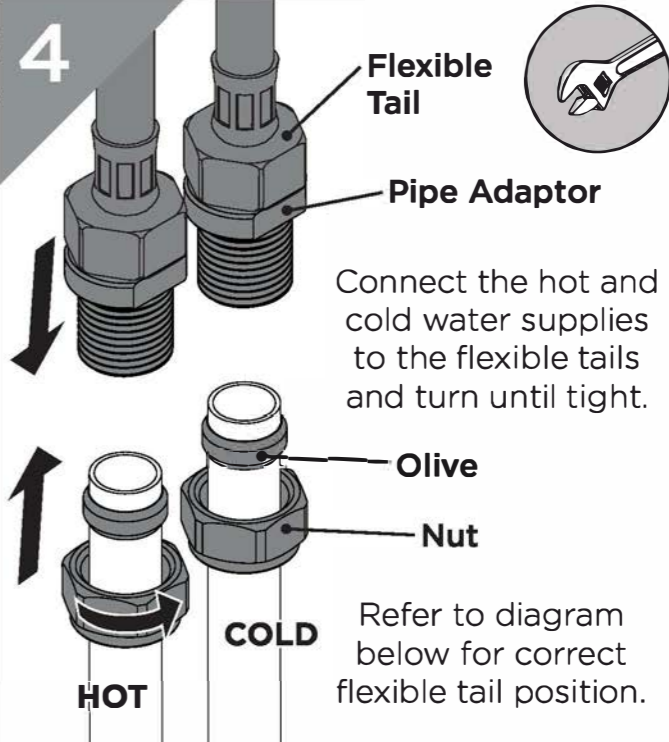

**5**

**IMPORTANT** Turn on water supply for a few minutes and check all joints and connections for any leaks.

Your tap is now ready for use.

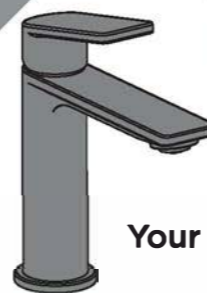

**Ensure flexible tails are positioned correctly.**

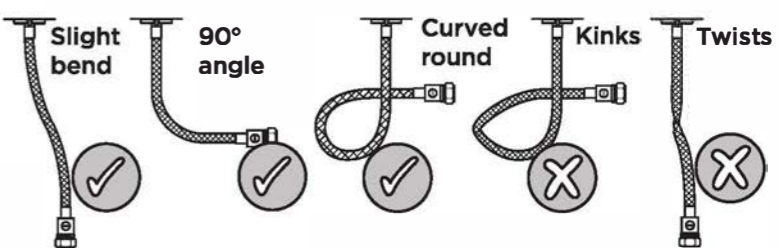

## Cartridge Maintenance - Isolate water supply before starting!

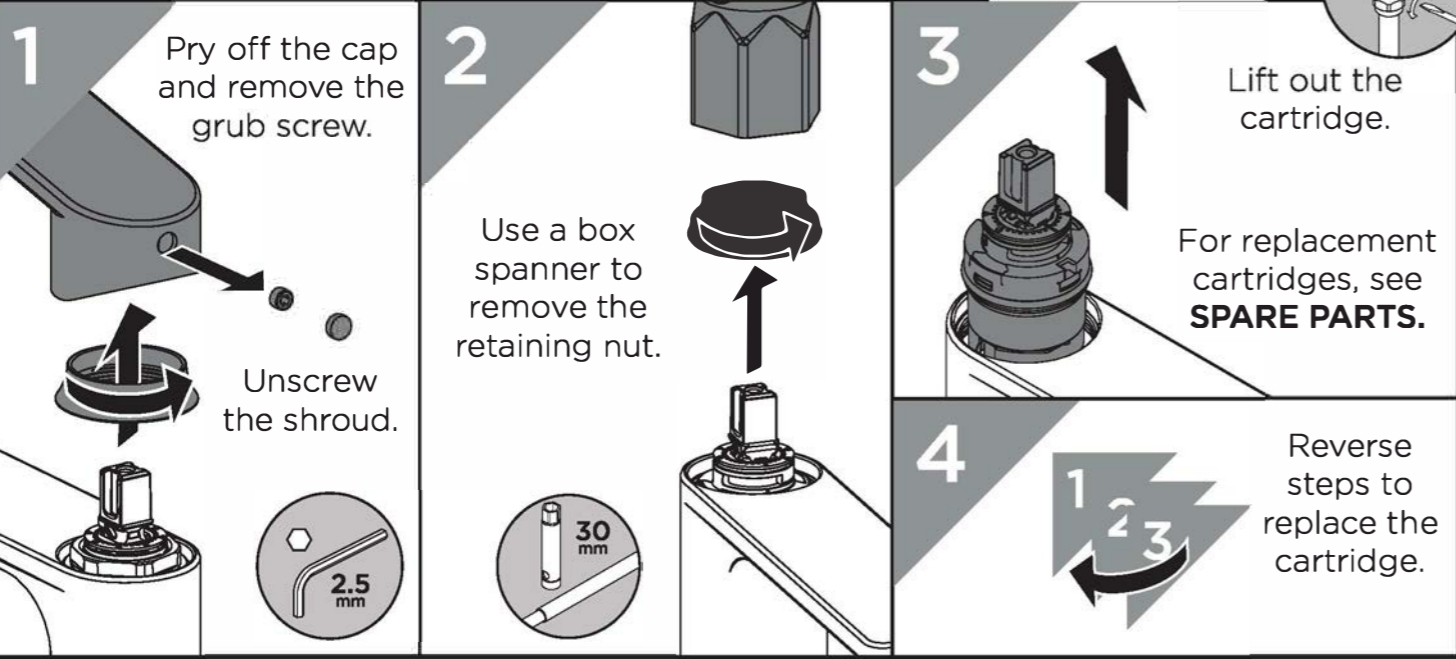

**1** Pry off the cap and remove the grub screw. Unscrew the shroud.

**2** Use a box spanner to remove the retaining nut.

**3** Lift out the cartridge. For replacement cartridges, see **SPARE PARTS**.

**4** Reverse steps to replace the cartridge.

2.5 mm  
30 mm

## Waste Installation and Operation

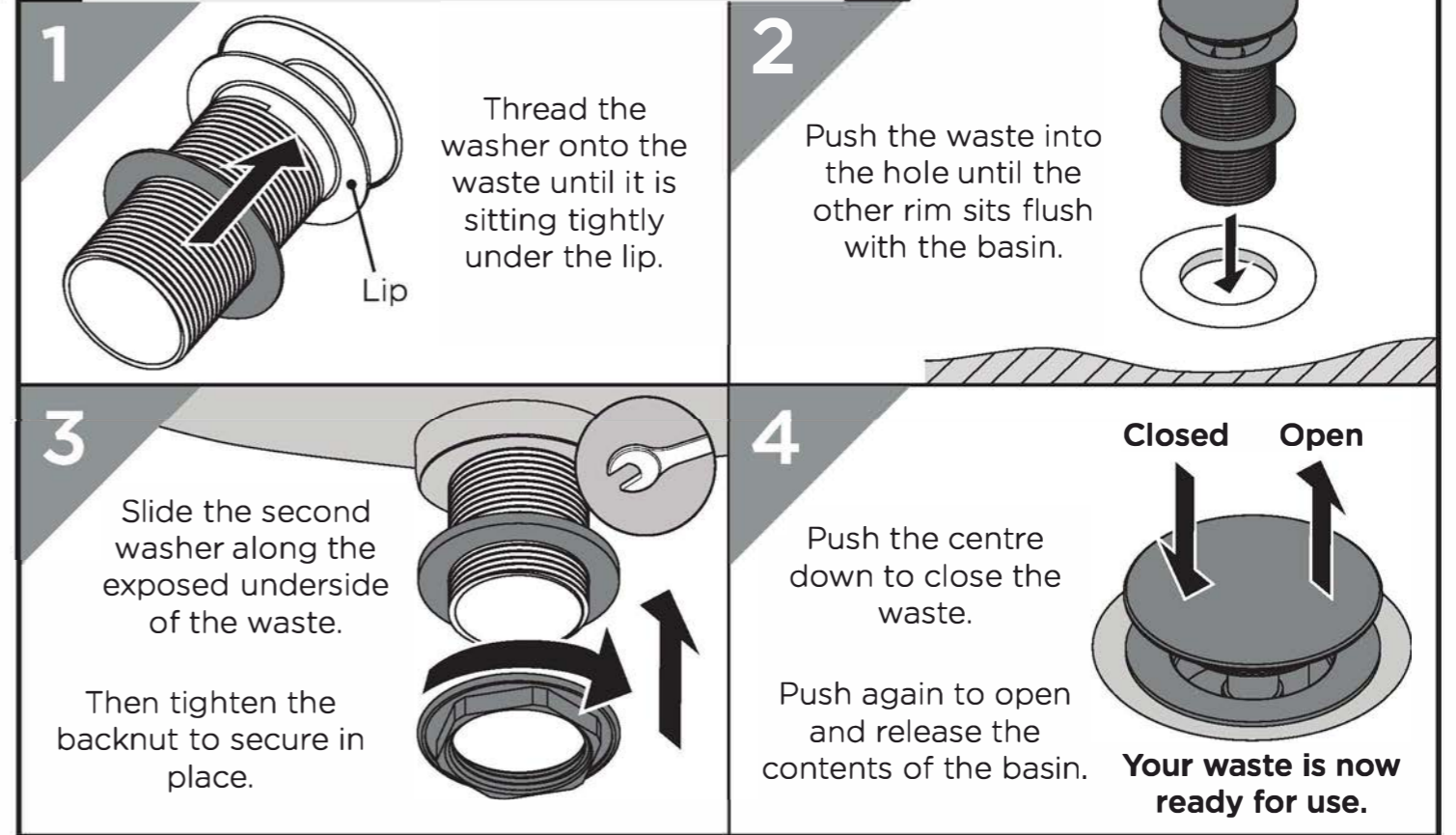

**1** Thread the washer onto the waste until it is sitting tightly under the lip.

**2** Push the waste into the hole until the other rim sits flush with the basin.

**3** Slide the second washer along the exposed underside of the waste. Then tighten the backnut to secure in place.

**4** Push the centre down to close the waste. Push again to open and release the contents of the basin. **Your waste is now ready for use.**

Lip  
Closed Open

## Outlet Cleaning

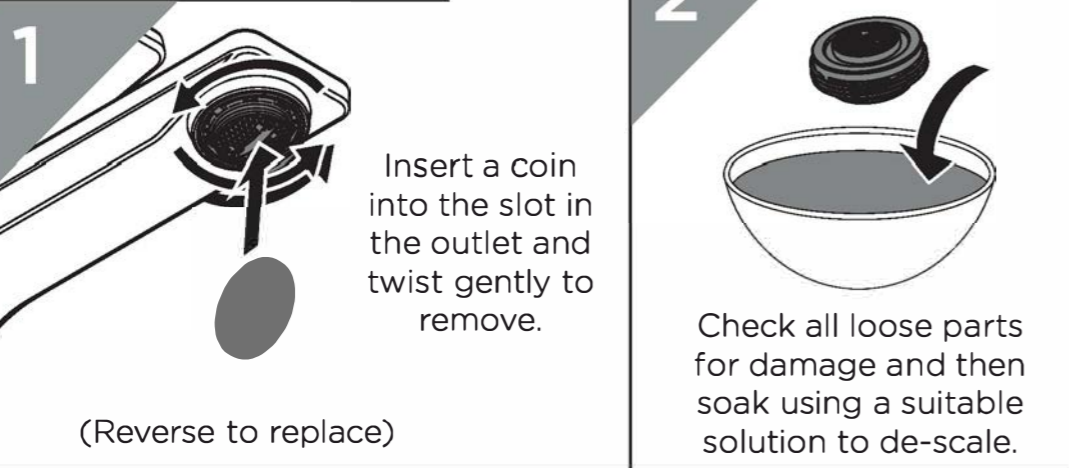

**1** Insert a coin into the slot in the outlet and twist gently to remove.

(Reverse to replace)

**2** Check all loose parts for damage and then soak using a suitable solution to de-scale.

## Spare Parts



To replace any spare parts for your tap, scan the QR Code or visit [www.bristan.com](http://www.bristan.com) and search for your product.

## Troubleshooting

Symptom	Cause	Remedy
Low Flow	Partially closed isolation valve.	Open isolation valve.
	Airlock or partial blockage in the supply pipework.	Flush through pipework to ensure removal of debris and any airlocks.
	Partial blockage in the outlet	Remove to Clean and soak in suitable solution.
No hot water or cycling hot and cold	Instantaneous water heater cycles on and off as flow rate or pressure is too low.	Increase water flow rate or pressure through system.
No Flow	Closed isolation valve.	Open isolation valve.
	Mains water supply turned off.	Turn on mains water supply.
Temperatures not corresponding with taps	Inlet pipes have been connected incorrectly	Swap the inlet tails around.

## General Cleaning

Bristan products are made from premium materials, with hand polished, electroplated, PVD or EPD finishes.

Your taps or shower should be regularly cleaned with warm water, a mild pH-neutral liquid soap, and polished with a soft cloth. Any residues from soap, toothpaste, shampoos and shower gels can cause blemishes if not rinsed off straight after use.

Household bleaches and cleaners contain harsh chemicals and may damage the surface finish. Avoid using abrasive cloths, scouring pads, scrub sponges, steel wool or anything similar.

## Contact Us

**Bristan Group Ltd.**  
A Masco Company

**BRISTAN**

Part of BRISTAN GROUP

**UK:** Bristan Group,  
Pooley Hall Drive,  
Birch Coppice Business Park,  
Dordon, Tamworth  
B78 1SG.

**EU:** Masco Europe S.à.r.l.  
14 Rue Strachen  
6933 Mensdorf  
Luxembourg

**Email Us:** [enquire@bristan.com](mailto:enquire@bristan.com)  
**Website:** [www.bristan.com](http://www.bristan.com)  
**Call Us:** +44330 026 6273

## Our Guarantee

At Bristan, we want to make things as easy as possible for our customers. That's why we offer solid guarantees on all our products, effective from the date of purchase, to give you peace of mind.

Your guarantee starts from the purchase of your product, but you can still benefit from registering it for easier identification in the unlikely event of a manufacturing fault, please visit [www.bristan.com/register](http://www.bristan.com/register)

For any other queries, please call Customer Service on 0330 026 6273 where our expert team of advisors will be able to offer you any help and advice.

For full guarantee terms and conditions visit [www.bristan.com/service-centre/guarantees](http://www.bristan.com/service-centre/guarantees)

