



Installation and operating instructions

# Remotely operated controller

## EasyControl

CT200 | CT200B



**Table of contents**

<b>1</b>	<b>Safety instructions</b> .....	<b>3</b>
1.1	Explanation of symbols .....	3
1.2	Safety instructions .....	3
<b>2</b>	<b>Environmental protection and disposal</b> .....	<b>3</b>
<b>3</b>	<b>Product Information</b> .....	<b>3</b>
3.1	Scope of delivery .....	3
3.2	Accessories .....	3
3.3	Warranty conditions .....	3
3.4	Declaration of Conformity (Europe) .....	3
3.5	FCC Statement (USA) .....	3
3.6	IC Statement (Canada) .....	4
3.7	Data privacy .....	4
3.8	Data connection .....	4
3.9	Proximity sensor and touch screen .....	4
3.10	Ambient Light .....	4
<b>4</b>	<b>Assembly</b> .....	<b>5</b>
4.1	Prior to installation .....	5
4.2	Determining the installation location .....	5
4.3	Fitting the wall plate .....	5
4.4	Connecting to the heat source .....	5
4.5	Installing (deinstalling) the controller .....	6
<b>5</b>	<b>Commissioning</b> .....	<b>6</b>
5.1	Powering up EasyControl .....	6
5.1.1	Connected heat source .....	6
5.1.2	Heat source is a gas boiler .....	6
5.1.3	Heat source is an AW heat pump .....	6
5.2	Software update .....	7
5.2.1	Software version information (for hybrid) .....	7
5.3	Operation of the touch screen .....	7
5.4	Connecting with WLAN network .....	7
5.5	Entering the WLAN network password .....	7
5.6	EasyControl app .....	8
5.7	Electronic thermostatically controlled radiator valve .....	8
5.8	UFH Thermostat .....	8
5.9	Wireless Room Thermostat .....	8
<b>6</b>	<b>Operation</b> .....	<b>8</b>
6.1	Start screen .....	8
6.2	Symbol background .....	9
6.3	Tab pages .....	9
6.4	Parental lock .....	9
6.5	Temperature setting .....	9
6.6	Manual operation or time program .....	9
6.7	Away setting .....	10
6.8	DHW heating .....	10
6.8.1	DHW heating settings heat source (gas boiler or district heating) .....	10
6.8.2	DHW heating settings AW heat pump .....	10
<b>7</b>	<b>Adjustments for boilers and hybrid systems with indoor unit</b> .....	<b>11</b>
7.1	WLAN setting .....	11

7.2	Reset .....	11
7.3	Start screen .....	11
7.4	QR code .....	11
<b>8</b>	<b>Hybrid systems without indoor unit</b> .....	<b>12</b>
8.1	Hybrid Commissioning .....	12
8.2	Main menu .....	14
8.2.1	Accessing the main menu .....	14
8.2.2	Error info .....	14
8.2.3	System info .....	14
8.2.4	Language selection .....	14
8.2.5	Menu: Reset .....	14
8.3	Service menu .....	15
8.3.1	Accessing the Service menu .....	15
8.3.2	Menu: Commissioning .....	15
8.3.3	Menu: Heat pump .....	15
8.3.4	Menu: Boiler .....	16
8.3.5	Menu: System .....	16
8.3.6	Menu: Error info .....	16
8.4	Service menu overview .....	16
<b>9</b>	<b>Troubleshooting</b> .....	<b>18</b>
<b>10</b>	<b>Technical data</b> .....	<b>19</b>
<b>11</b>	<b>ErP Class</b> .....	<b>20</b>
<b>12</b>	<b>List of used Open Source Components</b> .....	<b>20</b>
<b>13</b>	<b>Appendix</b> .....	<b>21</b>
13.1	Apache License 2.0 .....	21
13.2	BSD (Three Clause License) .....	22
13.3	MIT License .....	22
13.4	EPL-1.0 License .....	22
13.5	Eclipse Distribution License - v 1.0 .....	24
<b>14</b>	<b>Technical terms</b> .....	<b>24</b>

# 1 Safety instructions

## 1.1 Explanation of symbols

### Information symbol



Important information is placed between 2 lines and marked with an i-symbol in a square.

### Additional symbols

Symbol	Meaning
▶	a step in an action sequence
→	a reference to a related part in the document
•	a list entry
-	a list entry (second level)

Table 1



Please read this instruction carefully before use.

## 1.2 Safety instructions

This temperature controller is used to control a heat source in your dwelling.

- Do not disassemble the temperature controller under any circumstances.
- Avoid high temperatures, moisture and dusty environments.
- In order to prevent a short circuit or damage to the controller: Do not use any liquids or cleaning agents when cleaning.
- Switch off the mains voltage of the heat source before installing.

## 2 Environmental protection and disposal

Environmental protection is a fundamental corporate strategy of the Bosch Group.

The quality of our products, their economy and environmental safety are all of equal importance to us and all environmental protection legislation and regulations are strictly observed.

We use the best possible technology and materials for protecting the environment taking account of economic considerations.

### Packaging

Where packaging is concerned, we participate in country-specific recycling processes that ensure optimum recycling. All of our packaging materials are environmentally compatible and can be recycled.

### Used appliances

Used appliances contain valuable materials that can be recycled. The various assemblies can be easily dismantled. Synthetic materials are marked accordingly. Assemblies can therefore be sorted by composition and passed on for recycling or disposal.

### Used electrical and electronic appliances



Electrical or electronic devices that are no longer serviceable must be collected separately and sent for environmentally compatible recycling (in accordance with the European Waste Electrical and Electronic Equipment Directive).

To dispose of old electrical or electronic devices, you should use the return and collection systems put in place in the country concerned.

Batteries must not be disposed together with your household waste. Used batteries must be disposed of in local collection systems.

## 3 Product Information

### 3.1 Scope of delivery

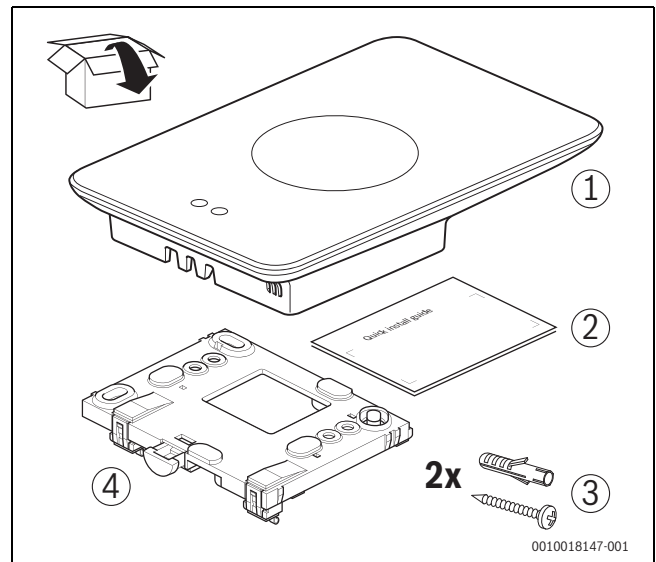

Fig. 1 Scope of delivery

- [1] EasyControl
- [2] Quick Install Guide
- [3] Screw with rawl plug 2 ×
- [4] Wall plate

### 3.2 Accessories

The following accessories are available:

- EasyControl app (free of charge)
- Smart Radiator Thermostats
- EasyControl Adaptor
- Table stand.
- UFH Thermostat.
- Wireless Thermostat.

Visit <https://www.bosch-easycontrol.com> for an up-to-date overview.

### 3.3 Warranty conditions

A manufacturer's warranty of 2 years is provided for EasyControl.

### 3.4 Declaration of Conformity (Europe)

 Hereby, Bosch Thermotechnik GmbH, declares that the radio equipment with type Thermostat AA are in compliance with Directive 2014/53/EU.

The complete text of the EU Declaration of Conformity is available on the Internet: <https://www.bosch-easycontrol.com>.

### 3.5 FCC Statement (USA)

This equipment has been tested and found to comply with the limits for a Class B digital device, pursuant to Part 15 of the FCC Rules. These limits are designed to provide reasonable protection against harmful interference in a residential installation.

This equipment generates, uses and can radiate radio frequency energy and, if not installed and used in accordance with the instructions, may cause harmful interference to radio communications. However, there is no guarantee that interference will not occur in a particular installation. If this equipment does cause harmful interference to radio or television reception, which can be determined by turning the equipment off and on, the user is encouraged to try to correct the interference by one of the following measures:

- Reorient or relocate the receiving antenna.
- Increase the separation between the equipment and receiver.
- Connect the equipment into an outlet on a circuit different from that to which the receiver is connected.
- Consult the dealer or an experienced radio/TV technician for help.
- To assure continued compliance, any changes or modifications not expressly approved by the party responsible for compliance could void the user's authority to operate this equipment. (Example - use only shielded interface cables when connecting to computer or peripheral devices).

This device complies with Part 15 of the FCC Rules. Operation is subject to the following two conditions:

- (1) This device may not cause harmful interference, and
- (2) This device must accept any interference received, including interference that may cause undesired operation.

### 3.6 IC Statement (Canada)

This device complies with Industry Canada licence-exempt RSS standard(s). Operation is subject to the following two conditions:

- (1) this device may not cause interference and
- (2) this device must accept any interference, including interference that

may cause undesired operation of the device.

Caution: Exposure to Radio Frequency Radiation.

To comply with RSS 102 RF exposure compliance requirements, for mobile configurations, a separation distance of at least 20 cm must be maintained between the antenna of this device and all persons. This device must not be co-located or operating in conjunction with any other antenna or transmitter.

Le présent appareil est conforme aux CNR d'Industrie Canada applicables aux appareils radio exempts de licence. L'exploitation est autorisée aux deux conditions suivantes :

- (1) l'appareil ne doit pas produire de brouillage, et
- (2) l'utilisateur de l'appareil doit accepter tout brouillage radioélectrique subi, même si le brouillage est susceptible d'en compromettre le fonctionnement.

Attention : Exposition aux rayonnements radioélectriques.

Pour se conformer aux exigences de conformité CNR 102 RF exposition, pour des configurations mobiles, une distance de séparation d'au moins 20 cm doit être maintenue entre l'antenne de cet appareil et toutes les personnes. Cet appareil ne doit pas être colocalisés ou fonctionnant en conjonction avec une autre antenne ou transmetteur.

### 3.7 Data privacy

Information about data protection can be found on the EasyControl site under Data protection.<sup>1)</sup>

### 3.8 Data connection

- ▶ EasyControl supports open WLAN connections and WLAN connections encrypted with WEP 128, WPA and WPA2 protocols. WPA2 is the safest protocol and is therefore preferred.
- ▶ "Hidden" networks are not supported (→ 5.4, P. 7).
- ▶ EasyControl takes over the time setting of the Bosch server. If there is no connection to the server, EasyControl can only be put into operation in manual operation.
- ▶ All costs for creating an Internet connection and a smart device are to be borne by the user.
- ▶ The type of connected heat source determines, which functions can be used. Consult the EasyControl site to gain an overview of which functions are available for which heat source.<sup>2)</sup>

1) See the back of this document for the web address.

### 3.9 Proximity sensor and touch screen

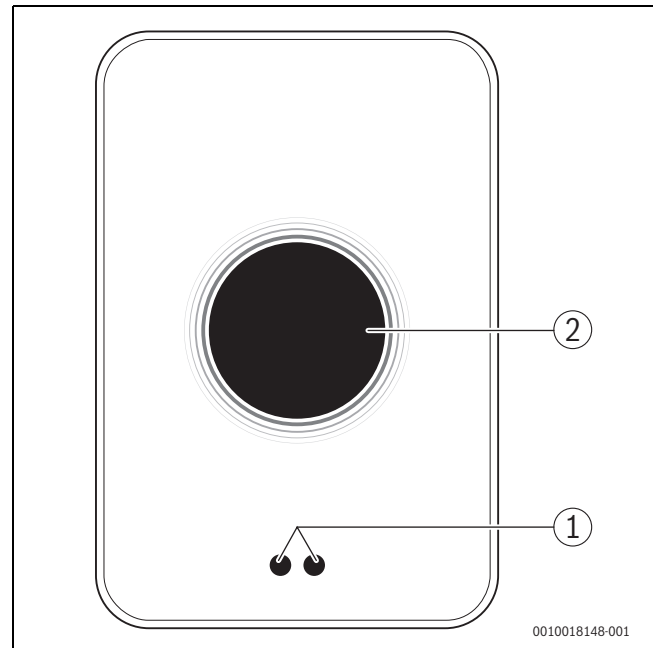

Fig. 2 Proximity sensor and touch screen

- [1] Proximity sensor
- [2] Touch screen

A proximity sensor [1] detects a presence in front of the touch screen [2] and lights up. If nothing more is detected for a short period of time, the touch screen automatically switches off. If the detection lasts for longer than 5 minutes, the touch screen automatically switches off.

- ▶ If required, clean the touch screen with a clean, dry cloth.

### 3.10 Ambient Light

EasyControl not only communicates with you via the app, but also via Ambient Light. As soon as you send a heating command via the app to EasyControl, it lights orange for a second when you increase the temperature, and blue when you lower the temperature. When you leave your home, a green light for a second indicates that the heating system has automatically switched to away mode. Red light: Error occurred in your heating system. If everything is running normally, Ambient Light will be off.

2) See the back of this document for the web address.

## 4 Assembly

### 4.1 Prior to installation

- ▶ Prior to installation, check that EasyControl can be combined with the heat source.

On the EasyControl site there is a list of possible combinations with or without the operation of EasyControl.<sup>1)</sup>

Minimum requirements for installation:

- ▶ 2-wire cable to a heat source, which is suitable for use with EasyControl.
- ▶ Broadband internet access via WLAN 802.11 b/g (2.4 GHz) for use with the app and internet functions.

### 4.2 Determining the installation location



A reference room is a room (for example the living room), where the temperature, which is representative of the whole dwelling, is measured, and where most time is spent.



If weather-compensated control is used, it is not necessary to locate the controller in the reference room.

- ▶ Install the controller on an internal wall in the reference room. Ensure that there is sufficient clearance around the controller.

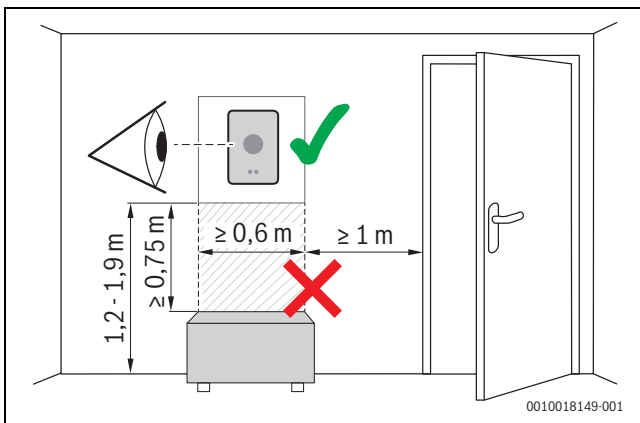

Fig. 3 Installation location for controller, clearance

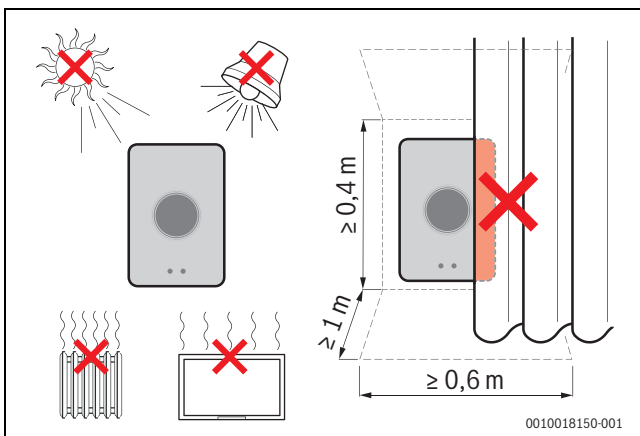

Fig. 4 Installation location for controller, condition

1) See the back of this document for the web address.

### 4.3 Fitting the wall plate



When replacing a controller with EasyControl, the existing wall plate can continue to be used (→ section 4.5).

This wall plate can be fastened directly to the wall, for example at the location of the previous controller.

- ▶ Pull the mains plug of the heat source from the socket.



When fitting to a recessed wall box, ensure that the room temperature measurement can not be impaired by any draughts. If required, stuff the recessed wall box with thermal insulation material.

- ▶ Connect the lead (EMS-BUS connection of the heat source) to the terminals on the wall plate. The wires can be connected in any order.

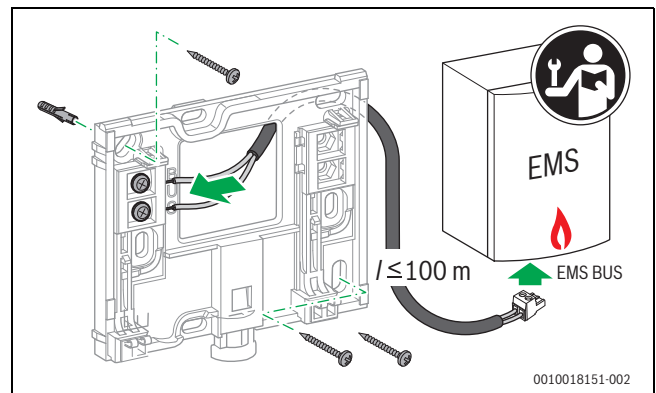

Fig. 5 Connecting the wall plate

### 4.4 Connecting to the heat source



The installation instructions for the heat source contain further information about the connection of EasyControl.

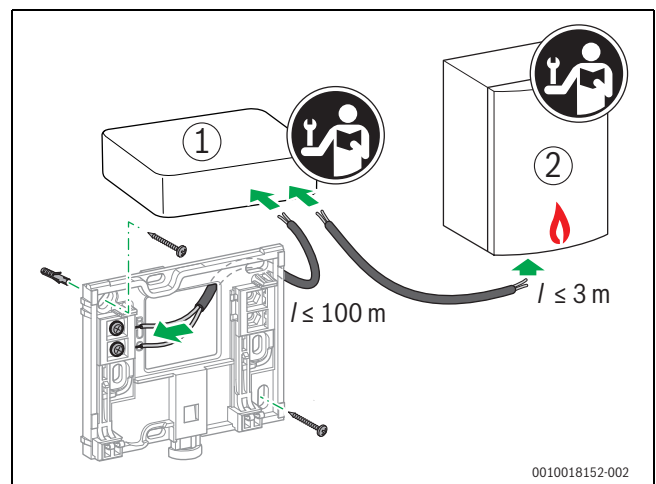

Fig. 6 Connecting the EasyControl adaptor

- [1] EasyControl adaptor
- [2] Heat sources which use iRT, OpenTherm or On-Off

There are various possibilities for connection to a heat source:

- Replacing an existing controller on the same wall plate. EasyControl is ready for operation.

- Bosch<sup>1)</sup> heat source appliance with a visible orange controller connection on the underside. Connect EasyControl with the orange connector at the orange terminal.
- Bosch • heat source appliance without a visible connection for the controller. The heat source must be opened by a recognized installer.
- Heat sources, which use iRT, OpenTherm or On-Off, can only be connected with an EasyControl adaptor (accessory).  
For more up-to-date information see the back of this document for the web address or consult a recognized installer.

#### 4.5 Installing (deinstalling) the controller

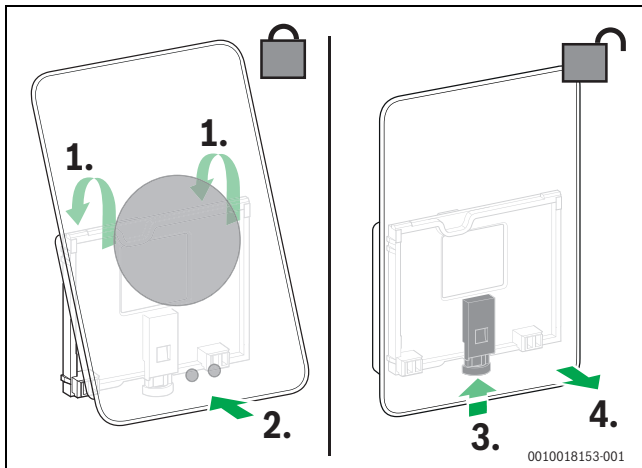

Fig. 7 Installing (deinstalling) the controller

##### Installing

- ▶ Hook EasyControl behind the wall plate[1].
- ▶ Press EasyControl with the underside against the wall plate, until an audible “click” is heard [2].  
EasyControl is now locked.

##### Deinstalling

- ▶ Unlock EasyControl by pressing the unlocking key [3].
- ▶ Slightly lift the underside of EasyControl and remove it [4].

## 5 Commissioning

### 5.1 Powering up EasyControl

- ▶ Remove the protective film from EasyControl.
- ▶ Plug the mains plug of the heat source into the socket.
- ▶ Switch on the heat source.

This also causes EasyControl to be supplied with mains voltage, and it searches for a connection to:

- the heat source [1],
- a WLAN network [2],
- the Bosch server [3].

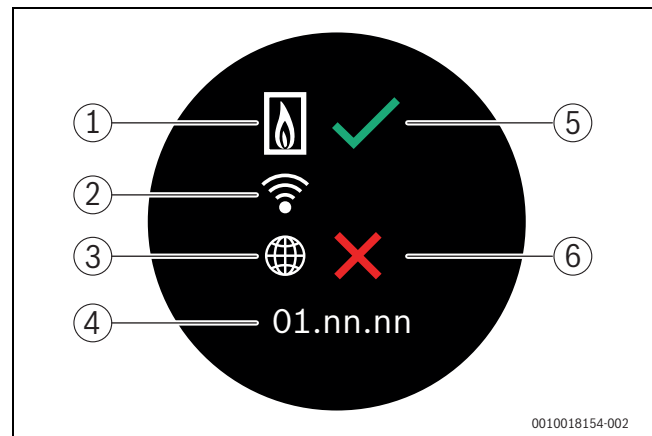

Fig. 8 Start screen

- [1] Connection with the heat source
- [2] Connection with WLAN network
- [3] Connection with Bosch server
- [4] Software version (example)
- [5] Connection made (example)
- [6] Connection not made (example)

#### 5.1.1 Connected heat source

A green check mark [5] shows, that the connection is made. A red cross [6] shows, that the connection is not made. See section 9, page 18 for an overview of possible causes and solutions.

#### 5.1.2 Heat source is a gas boiler

Power up EasyControl is finished. Switch to paragraph 5.2,

#### 5.1.3 Heat source is an AW heat pump

A green check mark [5] shows, that the connection is made. The EasyControl will be a remote control of the user interface HMC300/310 or HPC400/410 of the AW heat pump. If 2 or more (max. 4) heating/cooling circuits are installed, settings for each heating/cooling circuit is available and are necessary. Each heating circuit operates with its own remote control.

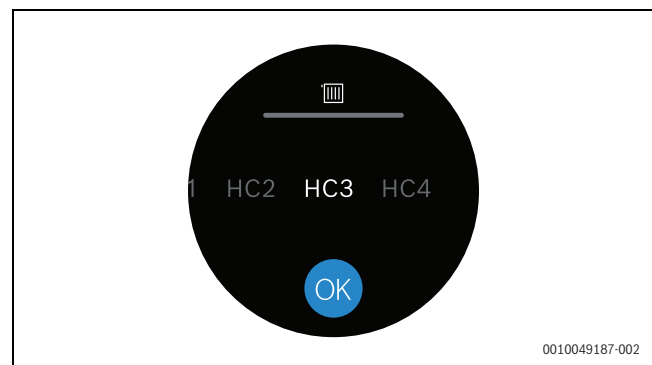

Fig. 9 Heating circuit selection

1) Or a Bosch Group brand (Nefit, Junkers, Worcester, ELM LeBlanc).

- ▶ Select heating circuit (HC1, HC2, HC3 or HC4). When wrong heating circuit is selected → 7, page 11.

The AW heat pump need to determine what accessories are connected to the EMS2 bus:

- ▶ Start configuration assistant on the user interface HMC300/310 or HPC400/410. Depending on the firmware version of the user interface, choose for: RC100H, TC100 or CT200.

## 5.2 Software update

The software version of this document is 05.XX.XX. The installed software version is shown in the start screen [4]. Software updates are performed automatically. It is possible that, when delivered, EasyControl does not yet have the current software version and does not therefore support all the functions in the app. The automatic update may take some time to start. Via the app an update can start immediately.



After an update has been performed, the arrangement of the touch screen may differ from this document. See the latest version of this document on the EasyControl site for Bosch.<sup>1)</sup>

### 5.2.1 Software version information (for hybrid)

To see more information about the current software version installed in the system:

- ▶ Click on the info symbol .

It is also possible to make software updates. To install a new software version:

- ▶ Click on the info symbol .
  - ▶ Select .
- A new software version is installed.

## 5.3 Operation of the touch screen

It is possible to change the settings by means of a horizontal or vertical wiping movement (swipe) or by pressing (tap). Only operate the touch screen with your hand.

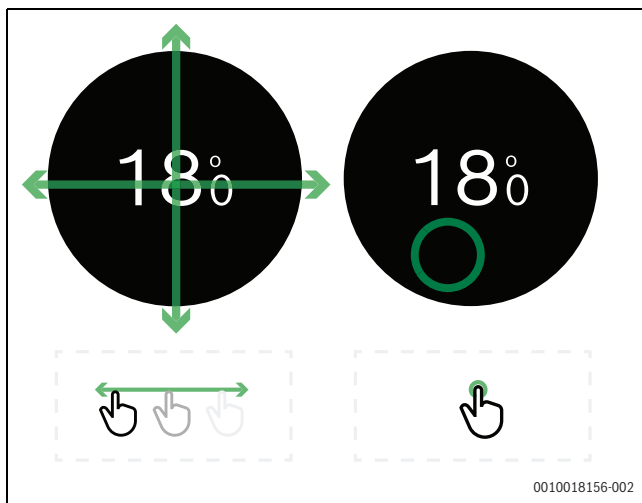

Fig. 10

## 5.4 Connecting with WLAN network

EasyControl can only make a connection to “visible” networks. If EasyControl is to establish a connection with a “hidden network”, this must first be made “visible”. After a connection has been established, the network can be “hidden” again.

After EasyControl has been connected to the heat source, it automatically searches for WLAN networks [3] and displays these on the

1) See the back of this document for the web address.

touch screen. While the search is being performed, a flashing WLAN symbol appears on the touch screen.

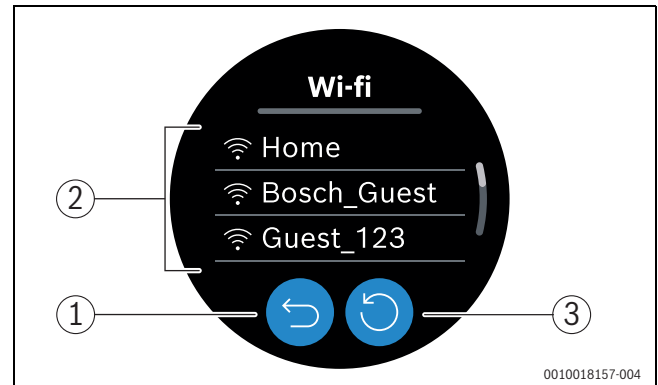

Fig. 11 Available WLAN networks

- [1] Cancel key
- [2] Refresh key
- [3] Available WLAN networks

- ▶ Swipe vertically to find the WLAN network.
- ▶ Select the desired WLAN network by tapping.

If the WLAN network is secured with a password:

- ▶ Enter the WLAN network password (→ section 5.5).

If the desired WLAN network is not found:

- ▶ Press the Cancel key [1] to set the controller to the Offline mode. The temperature can now only be set in manual operation on the touch screen. Connection to the app or Bosch site is not possible. Possible connection difficulties, → section 7, page 11 and chapter 9, page 18.

When all the connections have been established, the data is synchronised. The start screen appears on the touch screen.

## 5.5 Entering the WLAN network password



EasyControl uses the standard WLAN protocol.

- ▶ Do not use any special characters in the WLAN network password.

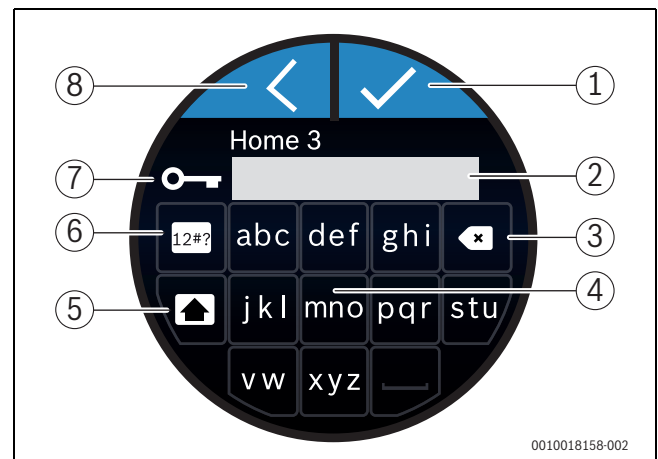

Fig. 12 Entering the WLAN network password

Using the Return key [8], one can return to the previous display. An input error can be corrected with the “Back” key [3]. An input is confirmed with the Enter key [1]. The password can be entered into the input line [2] using the keys [4]. Use the shift key [5] to enter capital letters. Using key [6], special characters can be entered. The lock key [7] shows, that the WLAN network is secured.

- ▶ Enter the WLAN network password.

- ▶ Confirm the password with the Enter key [1].  
Now the start screen appears (→ section 6.1).

## 5.6 EasyControl app

The EasyControl app contains functions, which are not included in EasyControl.

- ▶ Download the EasyControl app from Bosch.



- ▶ Install the EasyControl app from Bosch.
- ▶ Register the app with EasyControl.
- ▶ Enter the one-off access code or scan the QR code (→ sticker on the Quick Install Guide).
- ▶ Establish a connection with EasyControl.
- ▶ Enter the personalised password.

On <https://www.bosch-easycontrol.com> you can find an overview of the compatible smart devices.

## 5.7 Electronic thermostatically controlled radiator valve

EasyControl can establish a wireless connection with up to 19 Bosch electronic thermostatically controlled radiator valves (accessories). In this way different temperatures can be set in different rooms.

- ▶ Connect the electronic controller valves via the EasyControl app (pair). See the manual of the electronic thermostatically controlled radiator valves or use the steps in the EasyControl app.

## 5.8 UFH Thermostat

The EasyControl can establish a wireless connection with Underfloor Heating Thermostats (UFH, accessories).

To be able to set different temperatures in different zones, each zone must have an individual actuator connected to the UFH Thermostat.

Make sure to use the appropriate actuators for each thermostat type, for example, 24 V UFH Thermostats require 24 V actuators and 230 V UFH Thermostats require 230 V actuators. For further information, see the manual of the UFH Thermostat.

Connect the EasyControl to the UFH Thermostat via the EasyControl app.

## 5.9 Wireless Room Thermostat

The EasyControl can establish a wireless connection with a Wireless Room Thermostat (accessories).

The thermostat measures the room temperature centrally, disabling the temperature measurement of the valves. For further information, see the manual of the Wireless Room Thermostat.

Connect the EasyControl to the Wireless Room Thermostat via the EasyControl app.

## 6 Operation

### 6.1 Start screen

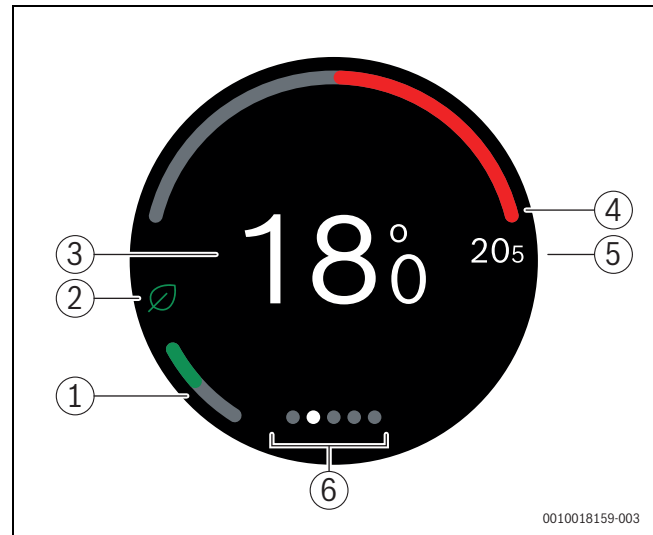

Fig. 13 Start screen

- [1] Display for economical heating
- [2] Eco symbol
- [3] Current room temperature
- [4] Display for heat source modulation level
- [5] Set temperature
- [6] Tab pages

If the touch screen is not used for some time, the device returns automatically to the start screen and the touch screen switches itself off.

The current room temperature is in the middle [1], and the set temperature is beside it [4]. The modulation level of the heat source is depicted with a display [3]. The Eco symbol [8] with the display for economical heating [7] shows, how energy-efficient the heating of the room is.







#### Notification symbols

The space for notification symbols [2] may contain the following symbols:

-  Away
-  No EMS
-  Stand-by

#### Operational symbols

The space for operational symbols [5] may contain the following symbols:

-  No WLAN connection
-  No connection with the Bosch server
-  DHW is maintained at temperature
-  DHW is not maintained at temperature
-  Heat source (boiler or district heating) in operation for CH
-  Heat source (boiler or district heating) in operation for CH optimum start
-  Heat pump in operation for CH

- Cooling active
- Electric auxiliary heating active
- Gas-powered auxiliary heating active
- Fire place (can be activated in single room solutions)
- Event
- Open Window Detection (can be activated in rooms with electronic thermostat valves)
- Boost (can be activated on RRCNG/main zone or rooms with electronic thermostat valves)

**Warning symbols**

The space for warning symbols [5] may contain the following symbols:

- Maintenance request or fault signal from the heat source
- Blocker fault from the heat source

**Symbols on tabs**

The following symbols may appear on the tabs:

- Manual operation
- Time program
- Home/Away setting
- DHW mode permanently On/Off
- DHW mode On/Off automatically
- DHW temperature Eco: operation with maximum DHW temperature at average energy consumption
- DHW temperature Eco+: operation with lowest DHW temperature at lowest energy consumption
- WLAN settings
- Settings
- Info menu
- Download

**6.2 Symbol background**

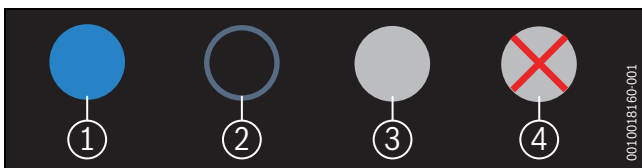

Fig. 14 Symbol background

Symbols can have differently coloured backgrounds. A light blue background shows, that this function is active. [1]. This button is no longer supported for software versions above 5.0 [2]. A grey background shows that this function is not active [3]. If a function is tapped, which is not available, a red cross appears over this background [4].

**6.3 Tab pages**

EasyControl contains several tab pages (→ fig. 6.1, [6]). The number of available tab pages depends on the system. The start screen is on the 1st tab page.

- ▶ Swipe right or left to change between the tab pages.

**6.4 Parental lock**

The screen can be disabled and enabled using the EasyControl app, the function is deactivated as standard.

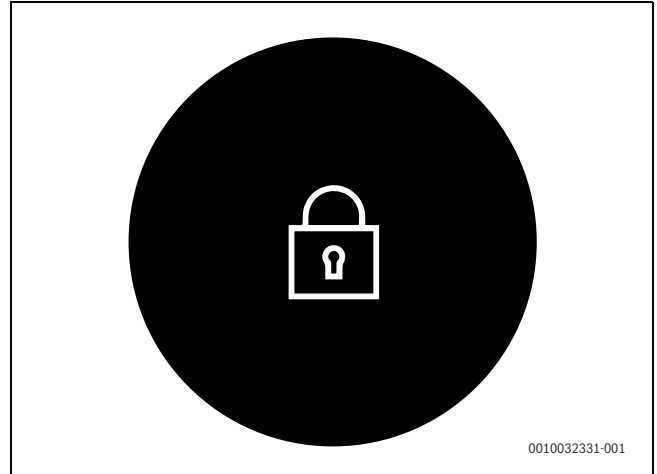

Fig. 15 Parental lock

**6.5 Temperature setting**

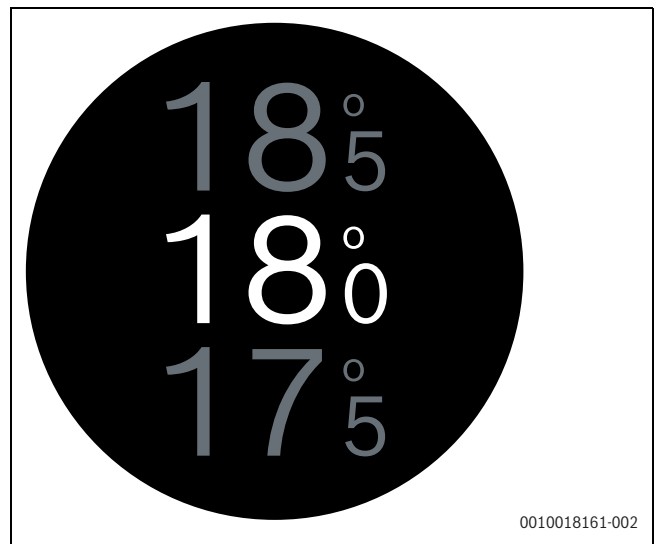

Fig. 16 Temperature setting

- ▶ Tap on the start screen to get to the temperature setting screen.
- ▶ Swipe vertically to increase or reduce the set temperature.

**6.6 Manual operation or time program**

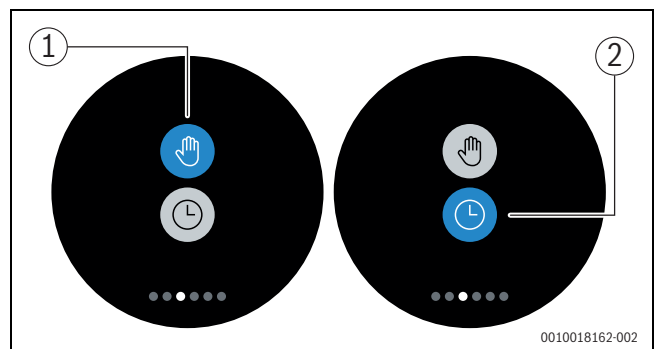

Fig. 17 Selecting manual operation or time program

The time program can be set with the EasyControl app. The time program can be switched on or off with EasyControl.

- ▶ Swipe horizontally to the correct tab page.
- ▶ Tap on the Manual operation [1] key or Time program [2] key to change between these functions.

### 6.7 Away setting

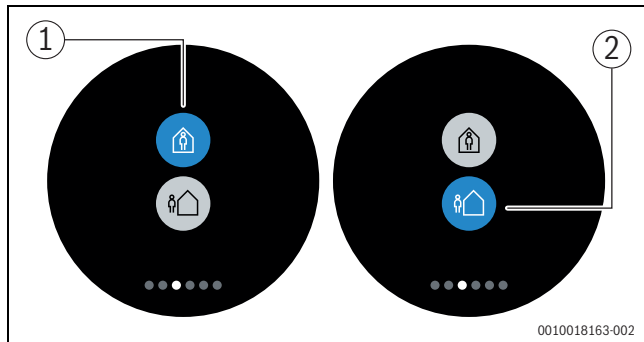

Fig. 18 Selecting "Not at home" or "At home"

The "Away" setting is used to show, whether one is at home or not. The set temperature is lowered in "Away from home status" by 15 °C (60 °F). This standard value can be changed in the EasyControlapp. This function is only available in time program mode.

- ▶ Swipe horizontally to the correct tab page.
- ▶ Tap on the "Home" [1] or "Away" [2] button to change between these functions.

### 6.8 DHW heating

If "DHW according to program" is switched on in the EasyControl app, the setting for DHW heating can be adjusted on EasyControl.

#### 6.8.1 DHW heating settings heat source (gas boiler or district heating)

For boilers or district heating systems EasyControl has three DHW settings.

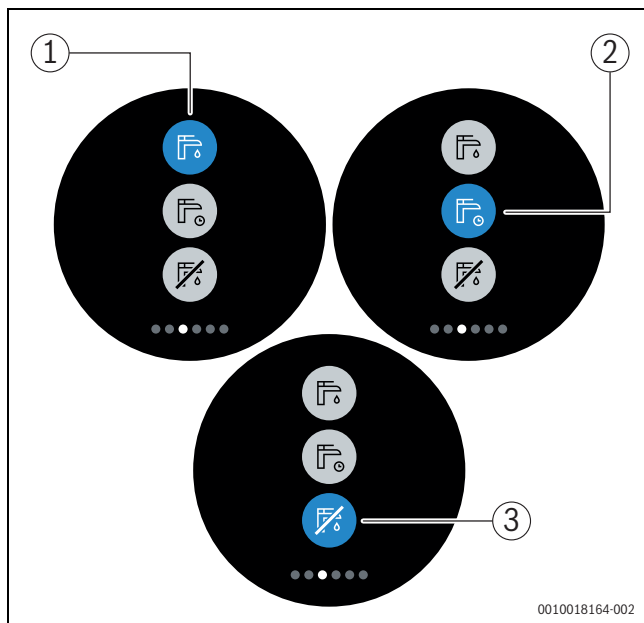

Fig. 19 DHW heating on, time program and off

- [1] DHW heating on
- [2] DHW heating with time program
- [3] DHW heating off

#### 6.8.2 DHW heating settings AW heat pump

When the EasyControl is connected to an AW heat pump, it has 5 different DHW settings.

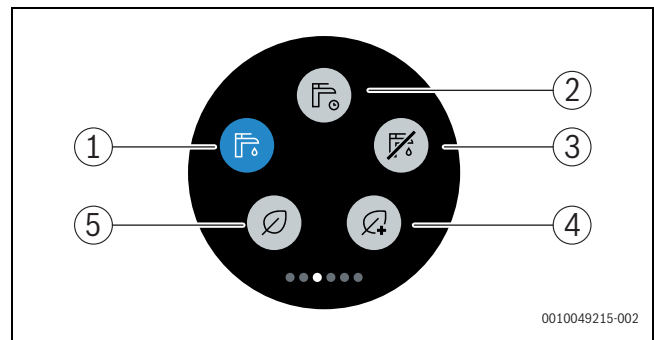

Fig. 20 DHW heating settings AW heat pump

- [1] DHW Comfort (DHW always on)
- [2] DHW Auto (DHW according own time program)
- [3] DHW Off
- [4] DHW temperature Eco+ (operation with lowest DHW temperature at lowest energy consumption)
- [5] DHW Eco (DHW temperature Eco: operation with maximum DHW temperature at average energy consumption)

## 7 Adjustments for boilers and hybrid systems with indoor unit

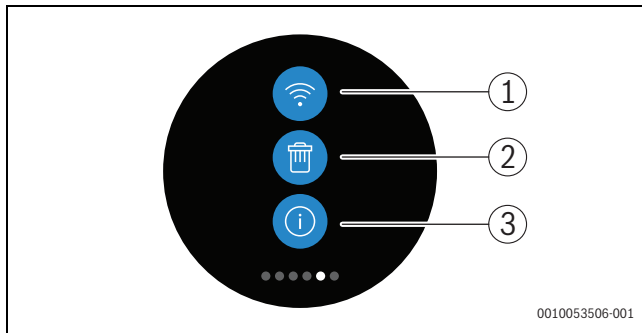

Fig. 21 WLAN settings

- [1] WLAN setting
- [2] Reset (factory settings)
- [3] Information about the current software version (→ Chapter 5.2 "Software update", page 7)

When the heat source is an AW Heat pump, during Power up EasyControl (→ Chapter 5.1 "Powering up EasyControl") a heating circuit need to be determined.

- ▶ When the wrong heating circuit is selected, give the i-button [3] a long press. The heating circuit can be selected again.

### 7.1 WLAN setting

- ▶ Press the WLAN symbol [1] to change the WLAN network or password.

### 7.2 Reset



All personal settings will be lost if the factory settings of the EasyControl are restored.

To avoid data losses when faults occur, you should initially try the suggested solutions (→ Chapter 9) or perform a soft reset.

#### Soft reset



Perform a soft reset while retaining all settings if EasyControl is no longer functioning correctly.

- ▶ Undock EasyControl briefly from the plinth (→ Fig. 4.5, page 6).

#### Hard reset (factory settings)

A hard reset restores the factory settings of the EasyControl. Following confirmation, the WLAN data is deleted and must be re-entered (→ Chapter 5.4).

##### 1. Hard reset via the touch screen

- ▶ Press the wastepaper basket symbol [2] to restore the factory settings. There are 2 options:
  -  Reset everything to the factory settings (**Attention!** Consumption data is lost).
  -  Restore factory settings subject to the consumption data.

##### 2. Hard reset with a paper clip

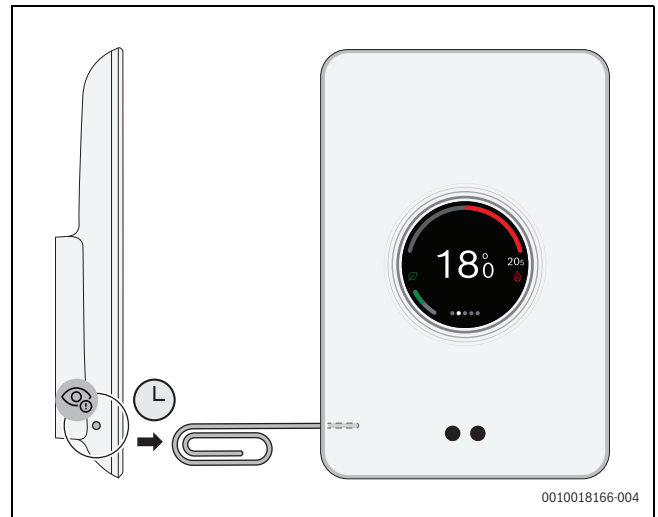

Fig. 22 Hard reset

- ▶ Press and hold the reset button (→ Fig. 22) for a few seconds. **Attention!** All personalised settings are deleted and the WLAN connection must be established again (→ Chapter 5.4).

If the problem persists:

- ▶ Consult the installer.

### 7.3 Start screen

A welcome screen can be activated via the EasyControl app. The basic screen is displayed if you swipe to the right. The function is deactivated as standard.

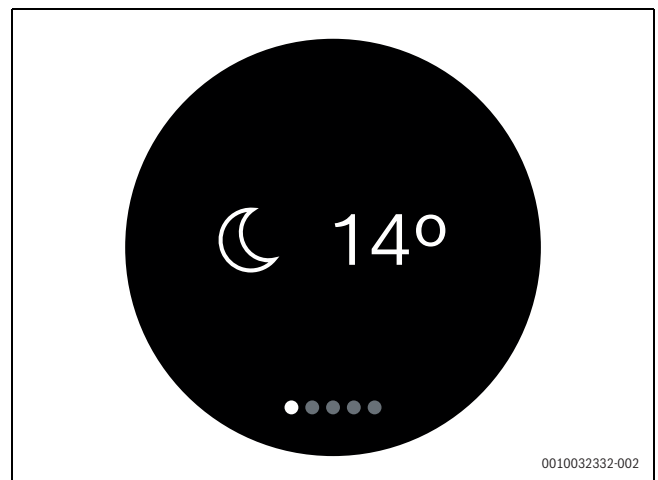

Fig. 23 Start screen

### 7.4 QR code

The QR code is displayed on the final tabs, where a connection can be established with the EasyControl app.



Fig. 24 QR code

---

## 8 Hybrid systems without indoor unit

### 8.1 Hybrid Commissioning



---

**Attention!** Only for installers.

---

The hybrid commissioning wizard includes the necessary steps to set up the hybrid system.

The appliance detects a hybrid system and automatically starts the hybrid commissioning wizard, even if the hybrid system is installed later.

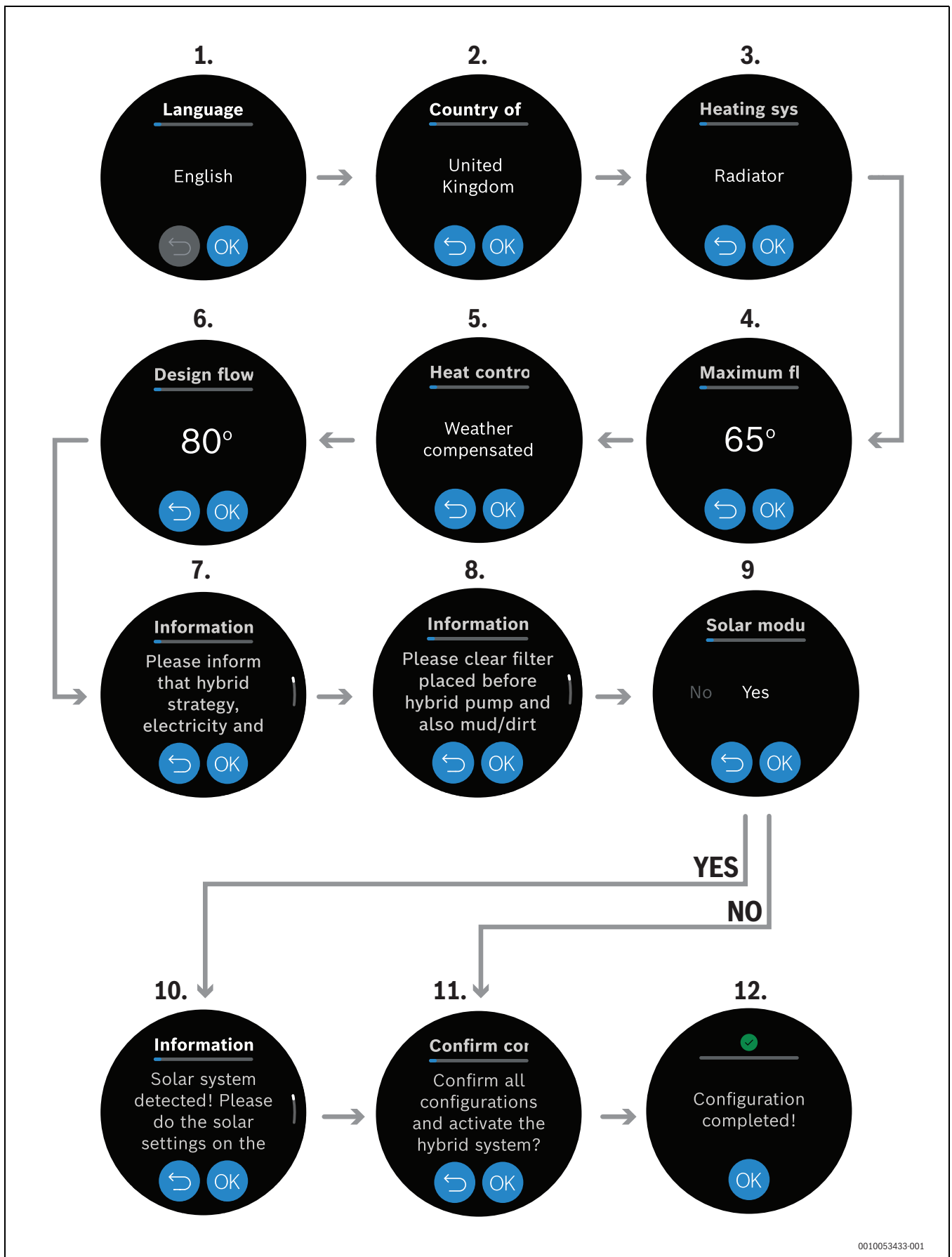

0010053433-001

Fig. 25 Hybrid system commissioning workflow

## 8.2 Main menu

### 8.2.1 Accessing the main menu

To access the main menu:

- ▶ Select .
- The main menu opens.

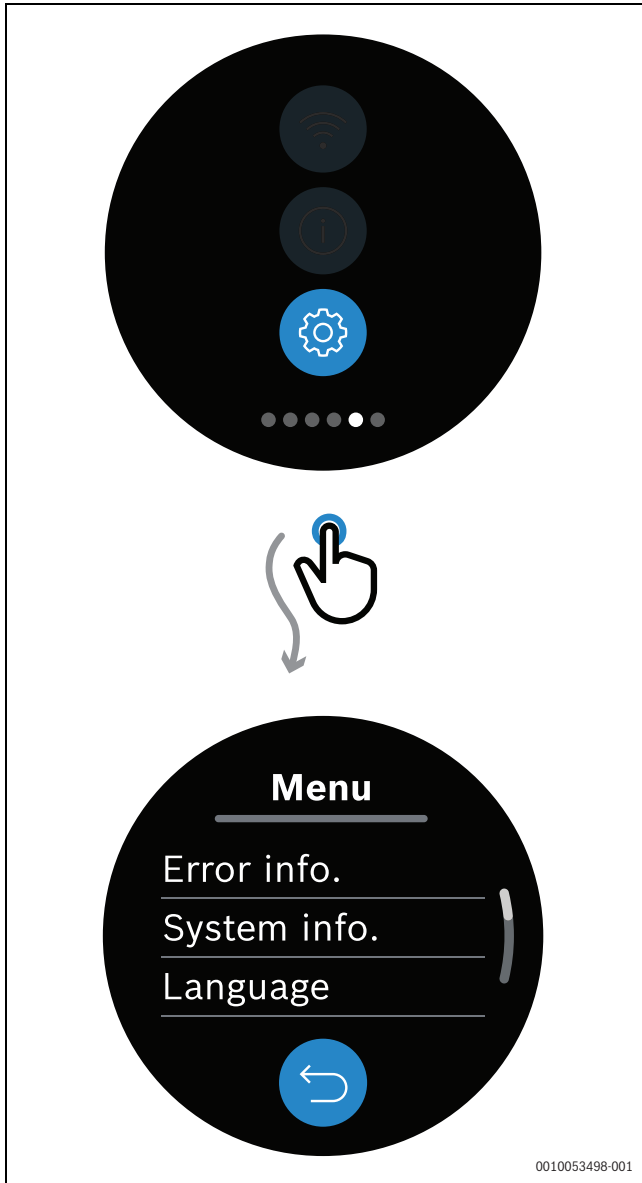



Fig. 26 Access to the main menu

### 8.2.2 Error info.

The Error info. menu shows a record of all active errors. The main screen also shows when there are active errors in the system through symbols (see → chapter 9 "Troubleshooting", page 18).

For more information about active errors:

- ▶ Click on .
- ▶ Select **Error info.**
- ▶ Select an error entry.  
The information about the error is shown.

### 8.2.3 System info.

#### Menu: Active heat source





It is possible to see the type of heat source that is active in the main menu:

- ▶ Click on .
- ▶ Select **System information.**

- ▶ Select **Active heat source.**  
The Active heat source is shown.

#### Active heat source types

The home screen shows when a heat source is active and also the type of heat source used:

-  Heat pump running.
-  Boiler running.
-  Heat pump and boiler running.
-  No appliance is running.

#### Menu: Low-noise op.

When the low-noise operation is active, the home screen shows the icon .

It is also possible to check if the low noise operation is active in the end customer menu:

- ▶ Click on .
- ▶ Select **System information.**
- ▶ Select **Low-noise op..**

#### Menu: Smart grid



The Smart grid menu shows the status of the operation of the smart grid:

- Operation blocked.
- Normal operation.
- Enhanced operation.
- Forced operation.

For further information about the different status of the operation of the smart grid, see the relevant documentation.



### 8.2.4 Language selection

To change the language of the system:

- ▶ Open the menu by clicking on .
- ▶ Click on **Language.**
- ▶ Select the correct language.
- ▶ Click  to save.

### 8.2.5 Menu: Reset

In the Reset menu, it is possible to reset the factory settings or the user settings only:

- ▶ Click on .
- ▶ Select **Reset.**
- ▶ Select **User settings** to reset the device to the default settings.
- or-
- ▶ Select **Factory**<sup>1)</sup> to erase all data and restore the default settings.  
A pop-up message appears.
- ▶ Click on  to cancel and go back to the Reset menu.
- or-
- ▶ Click on  to reset the settings.

1) **Attention!** Consumption data is lost.

### 8.3 Service menu

#### 8.3.1 Accessing the Service menu



**Attention!** Only for installers.

To access the Service menu:

- ▶ Press and hold for 3 seconds on . A countdown is shown in the screen. After 3 seconds, the Service menu opens.

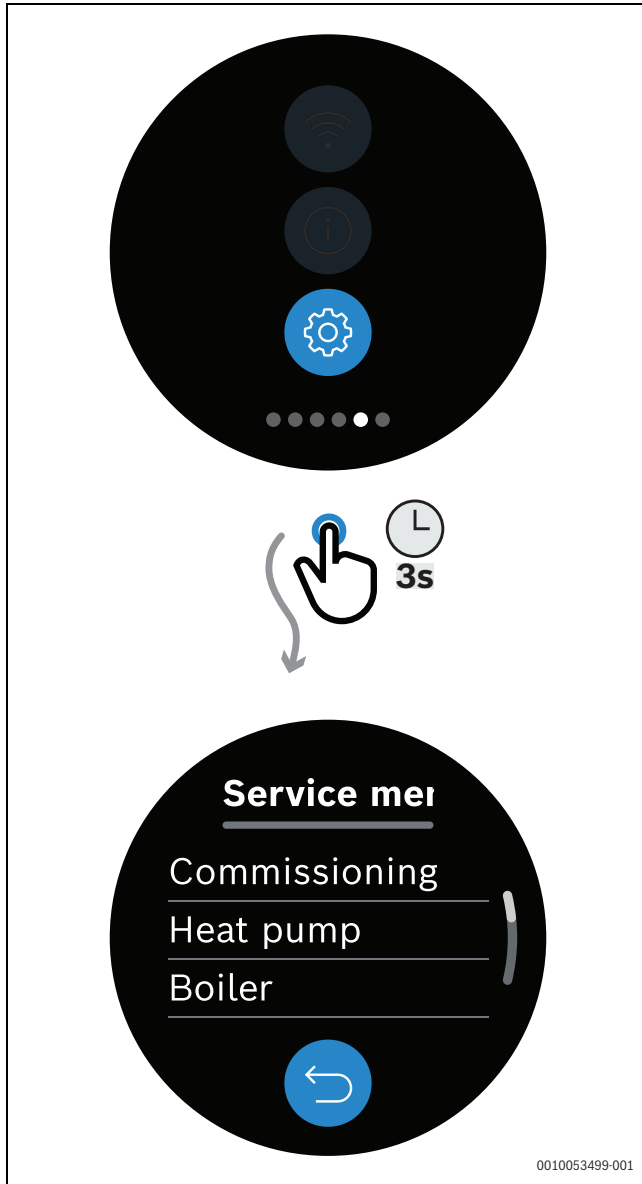

Fig. 27 Access to the Service menu.

#### 8.3.2 Menu: Commissioning

To access the Commissioning menu:

- ▶ Go to **Service menu**.
- ▶ Select **Commissioning**. The Commissioning menu opens.

Menu item	Description
Commissioning	• Heating system
	• Maximum flow temperature
	• Heat control type
	• Design flow temperature

Table 2

#### 8.3.3 Menu: Heat pump

To access the Heat pump menu:

- ▶ Go to Service menu.
- ▶ Select **Heat pump**. The Heat pump menu opens.

Menu item	Description
Settings	• Minimum flow temperature
	• Duel-fuel switch-over point (bivalent temperature)
	• Compressor quick start
	• Manual defrost
	• TC3-TH2 temperature difference heating
	• Low-noise operation (see → Chapter "Low-noise operation submenu", page 16)
Information	• TL2 temperature air intake
	• TL1 temperature air intake
	• TR5 temperature suction pipe
	• TR1 temperature compressor
	• TR6 temperature hot gas
	• TC3 temperature condenser
	• TR3 temperature condenser heating
	• TR4 temperature condenser cooling
	• TA4 temperature drain pan
	• JR0 temperature low pressure sensor
• JR1 temperature high pressure sensor	
• TC0 temperature return flow	

Table 3

### Low-noise operation submenu

To configure the Low-noise operation:

- ▶ Go to **Service menu**.
- ▶ Select **Heat pump**.  
The Heat pump menu opens.
- ▶ Select **Low-noise operation**.  
The Low-noise operation menu opens.

It is possible to select an Operation mode or a Power reduction level for the Low-noise operation.

In the **Low-noise operation** menu:

- ▶ Click on **Operation mode**.
- ▶ Select the mode for the Low-noise operation:
  - **Off**: to disable the Low-noise operation.
  - **Auto. - heat pump off**: the power of the heat pump is reduced during the selected time frame.<sup>1)</sup>
  - **Auto. - reduced output**: the power of the compressor is reduced during the selected time frame.<sup>1)</sup>
  - **Permanently reduced output**: the compressor power is reduced permanently.

-or-

- ▶ Click on **Power reduction**.
- ▶ Select the level of Power reduction.  
The power of the compressor is reduced according to the level selected.

#### 8.3.4 Menu: Boiler

To access the Boiler menu:

- ▶ Go to **Service menu**.
- ▶ Select **Boiler**.  
The Boiler menu opens.

Menu item	Description
Settings	<ul style="list-style-type: none"> <li>• Minimum modulation boiler pump</li> </ul>

Table 4

#### 8.3.5 Menu: System

To access the System information menu:

- ▶ Go to **Service menu**.
- ▶ Select **System information**.  
The System information menu opens.

Menu item	Description
Information	<ul style="list-style-type: none"> <li>• Frost protection</li> <li>• Frost protection threshold</li> </ul>
Settings	<ul style="list-style-type: none"> <li>• Active heat source</li> <li>• Current op. status</li> <li>• Flow temperature low loss header</li> <li>• PH0 flow rate</li> <li>• TH2 temperature return flow</li> <li>• T1 outside temperature</li> <li>• Country of installation</li> <li>• Software versions</li> </ul>

Table 5

#### 8.3.6 Menu: Error info.

The Error info. menu shows a record of all active errors.

The main screen also shows when there are active errors in the system through symbols (see → chapter 9 "Troubleshooting", page 18)

For more information about active errors:

- ▶ Go to **Service menu**.
- ▶ Select **Error info**.  
The Error info. menu opens.
- ▶ Select **Errors**.
- ▶ Select an error entry.  
The information about the error is shown.

It is also possible to reset alarms:

- ▶ Go to **Service menu**.
- ▶ Select **Error info**.  
The Error info. menu opens.
- ▶ Select **Reset alarms**.  
A confirmation message to reset the alarms is shown. By clicking , the request to reset alarms is sent.

## 8.4 Service menu overview

The menu options are shown in the order below. For access to the service menu, hold down the menu key until the countdown is complete (for approximately 3 seconds). The menu items shown may vary between different countries and markets.

### Service menu

---

#### Commissioning

---

- Heating system
  - Maximum flow temperature
  - Heat control type
  - Design flow temperature
- 

#### Heat pump

---

- Settings
    - Minimum flow temperature
    - Frost protection
    - Duel-fuel switch-over point
    - Compressor quick start
    - Manual defrost
    - TC3-TH2 temperature difference heating
    - Low-noise operation
      - Operation mode
      - Start time
      - End time
      - Power reduction
  - Information
    - TL2 temperature air intake
    - TL1 temperature air intake
    - TR5 temperature suction pipe
    - TR1 temperature compressor
    - TR6 temperature hot gas
    - TR3 temperature condenser heating
    - TR4 temperature condenser cooling
    - TA4 temperature drain pan
    - JR0 temperature low pressure sensor
    - JR1 temperature high pressure sensor
    - TCO temperature return flow
- 

#### Boiler

---

- Settings
    - Minimum modulation boiler pump
- 

#### System

---

- Information

1) It is necessary to set the Start time and End time to configure a time frame for the **Auto - heat pump off** and **Auto - reduced output** Low-noise operation modes.

- Frost protection
- Frost prot. limit temp.
- Settings
  - Active heat source
  - Current op. status
  - Flow temperature low loss header
  - PH0 flow rate
  - TH2 temperature return flow
  - T1 outside temperature
  - Country of installation
  - Software versions
    - Boiler
    - Hybrid manager
    - Outdoor unit

---

**Error info.**



---

- Errors
  - Reset alarms
-

## 9 Troubleshooting

The fault displays for the heat source are visible on the touch screen and are sent automatically from the thermostat to the EasyControl app. Contact with the installer can be selected in the app.

There is an extensive list on the EasyControl site of solutions to problems that can arise in relation to the EasyControl thermostat.<sup>1)</sup>

Error	Solution
	No WLAN connection. The WLAN signal of the WLAN router may be too weak. Use a WLAN amplifier. There is possibly a defect in the WLAN router or the WLAN router password may have been changed.
<b>WLAN network not found</b>	The "Hide" function of the WLAN router is possibly switched on, or the "Broadcast" function (sending of the SSID) may be switched off. Temporarily switch off the "Hide" function or switch on the "Broadcast" function.
	No connection to the Internet server. Wait until the connection to the Internet server has been automatically restored. Even without a server connection, the heat source can be controlled in manual operation or via the time program following commissioning.
<b>Forgotten serial number and access code</b>	The serial number and access code are on the sticker, which is on the front of the quick-reference installation instructions, and on the sticker at the back of the EasyControl and are worked into the QR code, which can be used to enter them. If the app is used to log on, the serial number and access code can be displayed by navigating via the "Info menu" to the "Product information" submenu. If the serial number and access code cannot be found, please contact "Consumer Info". <sup>1)</sup>
<b>App has no contact with EasyControl</b>	Is the EasyControl connected to the Internet (→ Chapter 5.4)? Have the serial number and access code been entered? Caution, these are case sensitive. There is possibly a slow Internet connection. Wait for a few minutes.
<b>The displayed temperature is too high or too low</b>	The displayed temperature can be set in the app or on the EasyControl site <sup>1)</sup> .
<b>The touch screen is not working</b>	If the touch screen does not detect anything for more than 5 minutes, it automatically switches itself off. The touch screen can then only be reactivated by touching it.
<b>Password with \$ character</b>	EasyControl uses the standard WLAN protocol. The password for the WLAN network must therefore not contain the \$ character. Remove the \$ character from the network password.
<b>App is not fully functioning</b>	When the EasyControl is removed from the packaging following delivery, the latest version of the software may not yet be installed on it. This means that possibly not all app functions can be used. The software is automatically updated and may take several hours, or can be updated manually via the EasyControl app: <i>Info – About – Checking &amp; Update</i> .
	The heat source has developed a fault. More information is provided in the EasyControl app.

Error	Solution
	Display of one of the following messages: repeated ignition attempts, dripping/leaking DHW tap, flow rate through the heating system too low, leak in the heating system, filling pressure of heating system too low, or a service display is indicated at the heat source. These are informative signals. The heat source is working normally.
<b>No software updates have been received from EasyControl</b>	The software updates are performed automatically. A continuous Internet connection is required for this. Updates may be missed if a timer is set on the router.

Table 6 Fault overview (the symbols are displayed on the touch screen)

1) See the rear of this document for the web address.

**10 Technical data**

CT200 & CT200B		
Description	Unit	Value
<b>U</b>	V <sub>DC</sub>	14.3 – 16.0
<b>P<sub>max</sub></b>	W	0.9
<b>m</b>	g (lb)	250 (0.551)
<b>f1 (RF)</b>	f = 868.3 ... 869.5 MHz [EU]	(P = max. 13.4 dBm)
<b>T<sub>amb</sub></b>	°C (°F)	0 ... 45 (32 ... 113)
<b>IP-class</b>		IP30
<b>φ</b>	% RH	10 ... 90
<b>WLAN</b>	f = 2400 MHz ... 2483.5 MHz	IEEE 802.11b (P = max. 17 dBm) IEEE 802.11g (P = max. 14.1 dBm)
<b>f2 (RF)</b>	f = 2400 MHz ... 2483.5 MHz	IEEE 802.15.4 (P = max. 14.6 dBm)
	mm (inch)	h = 153 (6) w = 103 (4) d = 24 (1)

Table 7

## 11 ErP Class

The data in the table below is needed to fill out the Energy related Product (ErP) form and the ErP Data Label sticker, which are required for systems.

Supplier is "Bosch, Bosch Group", the model is "EasyControl".

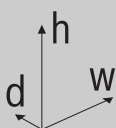
Operating functions and ErP description	ErP class	Additional room heating energy efficiency
Room temperature-dependent, modulating	V	3%
Weather-compensated with influence of room temperature, modulating	VI	4%
Room temperature control system with several temperature sensors (zone control), modulating	VIII	5%

Table 8

## 12 List of used Open Source Components

The following text is in English for legal reasons.

The following open source software (OSS) components are included in this product:

Name of OSS Component	Version of OSS Component	Name and Version of License (License text can be found in 13)	URL of origin and additional information (copyright, copyleft and modification notices; type of link: static/dynamic,...)*
MD5	2.2.1	Apache License 2.0	Appendix 13.1 Copyright © 2006-2015, ARM Limited, All Rights Reserved

Table 9

\*) Components used by external supplier

## 13 Appendix

### 13.1 Apache License 2.0

Apache License Version 2.0, January 2004

<http://www.apache.org/licenses/>

TERMS AND CONDITIONS FOR USE, REPRODUCTION, AND DISTRIBUTION

#### 1. Definitions.

"License" shall mean the terms and conditions for use, reproduction, and distribution as defined by Sections 1 through 9 of this document. "Licensor" shall mean the copyright owner or entity authorized by the copyright owner that is granting the License. "Legal Entity" shall mean the union of the acting entity and all other entities that control, are controlled by, or are under common control with that entity. For the purposes of this definition, "control" means (i) the power, direct or indirect, to cause the direction or management of such entity, whether by contract or otherwise, or (ii) ownership of fifty percent (50%) or more of the outstanding shares, or (iii) beneficial ownership of such entity. "You" (or "Your") shall mean an individual or Legal Entity exercising permissions granted by this License. "Source" form shall mean the preferred form for making modifications, including but not limited to software source code, documentation source, and configuration files. "Object" form shall mean any form resulting from mechanical transformation or translation of a Source form, including but not limited to compiled object code, generated documentation, and conversions to other media types. "Work" shall mean the work of authorship, whether in Source or Object form, made available under the License, as indicated by a copyright notice that is included in or attached to the work (an example is provided in the Appendix below). "Derivative Works" shall mean any work, whether in Source or Object form, that is based on (or derived from) the Work and for which the editorial revisions, annotations, elaborations, or other modifications represent, as a whole, an original work of authorship. For the purposes of this License, Derivative Works shall not include works that remain separable from, or merely link (or bind by name) to the interfaces of, the Work and Derivative Works thereof. "Contribution" shall mean any work of authorship, including the original version of the Work and any modifications or additions to that Work or Derivative Works thereof, that is intentionally submitted to Licensor for inclusion in the Work by the copyright owner or by an individual or Legal Entity authorized to submit on behalf of the copyright owner. For the purposes of this definition, "submitted" means any form of electronic, verbal, or written communication sent to the Licensor or its representatives, including but not limited to communication on electronic mailing lists, source code control systems, and issue tracking systems that are managed by, or on behalf of, the Licensor for the purpose of discussing and improving the Work, but excluding communication that is conspicuously marked or otherwise designated in writing by the copyright owner as "Not a Contribution." "Contributor" shall mean Licensor and any individual or Legal Entity on behalf of whom a Contribution has been received by Licensor and subsequently incorporated within the Work.

#### 2. Grant of Copyright License.

Subject to the terms and conditions of this License, each Contributor hereby grants to You a perpetual, worldwide, non-exclusive, no-charge, royalty-free, irrevocable copyright license to reproduce, prepare Derivative Works of, publicly display, publicly perform, sublicense, and distribute the Work and such Derivative Works in Source or Object form

#### 3. Grant of Patent License.

Subject to the terms and conditions of this License, each Contributor hereby grants to You a perpetual, worldwide, non-exclusive, no-charge, royalty-free, irrevocable (except as stated in this section) patent license to make, have made, use, offer to sell, sell, import, and otherwise transfer the Work, where such license applies only to those patent claims licensable by such Contributor that are necessarily infringed by

their Contribution(s) alone or by combination of their Contribution(s) with the Work to which such Contribution(s) was submitted. If You institute patent litigation against any entity (including a cross-claim or counterclaim in a lawsuit) alleging that the Work or a Contribution incorporated within the Work constitutes direct or contributory patent infringement, then any patent licenses granted to You under this License for that Work shall terminate as of the date such litigation is filed.

#### 4. Redistribution.

You may reproduce and distribute copies of the Work or Derivative Works thereof in any medium, with or without modifications, and in Source or Object form, provided that You meet the following conditions: 1. You must give any other recipients of the Work or Derivative Works a copy of this License; and 2. You must cause any modified files to carry prominent notices stating that You changed the files; and 3. You must retain, in the Source form of any Derivative Works that You distribute, all copyright, patent, trademark, and attribution notices from the Source form of the Work, excluding those notices that do not pertain to any part of the Derivative Works; and 4. If the Work includes a "NOTICE" text file as part of its distribution, then any Derivative Works that You distribute must include a readable copy of the attribution notices contained within such NOTICE file, excluding those notices that do not pertain to any part of the Derivative Works, in at least one of the following places: within a NOTICE text file distributed as part of the Derivative Works; within the Source form or documentation, if provided along with the Derivative Works; or, within a display generated by the Derivative Works, if and wherever such third-party notices normally appear. The contents of the NOTICE file are for informational purposes only and do not modify the License. You may add Your own attribution notices within Derivative Works that You distribute, alongside or as an addendum to the NOTICE text from the Work, provided that such additional attribution notices cannot be construed as modifying the License. You may add Your own copyright statement to Your modifications and may provide additional or different license terms and conditions for use, reproduction, or distribution of Your modifications, or for any such Derivative Works as a whole, provided Your use, reproduction, and distribution of the Work otherwise complies with the conditions stated in this License.

#### 5. Submission of Contributions.

Unless You explicitly state otherwise, any Contribution intentionally submitted for inclusion in the Work by You to the Licensor shall be under the terms and conditions of this License, without any additional terms or conditions. Notwithstanding the above, nothing herein shall supersede or modify the terms of any separate license agreement you may have executed with Licensor regarding such Contributions.

#### 6. Trademarks.

This License does not grant permission to use the trade names, trademarks, service marks, or product names of the Licensor, except as required for reasonable and customary use in describing the origin of the Work and reproducing the content of the NOTICE file.

#### 7. Disclaimer of Warranty.

Unless required by applicable law or agreed to in writing, Licensor provides the Work (and each Contributor provides its Contributions) on an "AS IS" BASIS, WITHOUT WARRANTIES OR CONDITIONS OF ANY KIND, either express or implied, including, without limitation, any warranties or conditions of TITLE, NON-INFRINGEMENT, MERCHANTABILITY, or FITNESS FOR A PARTICULAR PURPOSE. You are solely responsible for determining the appropriateness of using or redistributing the Work and assume any risks associated with Your exercise of permissions under this License

#### 8. Limitation of Liability.

In no event and under no legal theory, whether in tort (including negligence), contract, or otherwise, unless required by applicable law (such as deliberate and grossly negligent acts) or agreed to in writing, shall any Contributor be liable to You for damages, including any direct,

indirect, special, incidental, or consequential damages of any character arising as a result of this License or out of the use or inability to use the Work (including but not limited to damages for loss of goodwill, work stoppage, computer failure or malfunction, or any and all other commercial damages or losses), even if such Contributor has been advised of the possibility of such damages.

### 9. Accepting Warranty or Additional Liability.

While redistributing the Work or Derivative Works thereof, You may choose to offer, and charge a fee for, acceptance of support, warranty, indemnity, or other liability obligations and/or rights consistent with this License. However, in accepting such obligations, You may act only on Your own behalf and on Your sole responsibility, not on behalf of any other Contributor, and only if You agree to indemnify, defend, and hold each Contributor harmless for any liability incurred by, or claims asserted against, such Contributor by reason of your accepting any such warranty or additional liability.

### 13.2 BSD (Three Clause License)

Redistribution and use in source and binary forms, with or without modification, are permitted provided that the following conditions are met:

- Redistributions of source code must retain the above copyright notice, this list of conditions and the following disclaimer.
- Redistributions in binary form must reproduce the above copyright notice, this list of conditions and the following disclaimer in the documentation and/or other materials provided with the distribution.
- Neither the name of the copyright holder nor the names of its contributors may be used to endorse or promote products derived from this software without specific prior written permission.

THIS SOFTWARE IS PROVIDED BY THE COPYRIGHT HOLDERS AND CONTRIBUTORS "AS IS" AND ANY EXPRESS OR IMPLIED WARRANTIES, INCLUDING, BUT NOT LIMITED TO, THE IMPLIED WARRANTIES OF MERCHANTABILITY AND FITNESS FOR A PARTICULAR PURPOSE ARE DISCLAIMED. IN NO EVENT SHALL THE COPYRIGHT HOLDER OR CONTRIBUTORS BE LIABLE FOR ANY DIRECT, INDIRECT, INCIDENTAL, SPECIAL, EXEMPLARY, OR CONSEQUENTIAL DAMAGES (INCLUDING, BUT NOT LIMITED TO, PROCUREMENT OF SUBSTITUTE GOODS OR SERVICES; LOSS OF USE, DATA, OR PROFITS; OR BUSINESS INTERRUPTION) HOWEVER CAUSED AND ON ANY THEORY OF LIABILITY, WHETHER IN CONTRACT, STRICT LIABILITY, OR TORT (INCLUDING NEGLIGENCE OR OTHERWISE) ARISING IN ANY WAY OUT OF THE USE OF THIS SOFTWARE, EVEN IF ADVISED OF THE POSSIBILITY OF SUCH DAMAGE.

### 13.3 MIT License

Permission is hereby granted, free of charge, to any person obtaining a copy of this software and associated documentation files (the "Software"), to deal in the Software without restriction, including without limitation the rights to use, copy, modify, merge, publish, distribute, sublicense, and/or sell copies of the Software, and to permit persons to whom the Software is furnished to do so, subject to the following conditions: The above copyright notice and this permission notice shall be included in all copies or substantial portions of the Software.

THE SOFTWARE IS PROVIDED "AS IS", WITHOUT WARRANTY OF ANY KIND, EXPRESS OR IMPLIED, INCLUDING BUT NOT LIMITED TO THE WARRANTIES OF MERCHANTABILITY, FITNESS FOR A PARTICULAR PURPOSE AND NONINFRINGEMENT. IN NO EVENT SHALL THE AUTHORS OR COPYRIGHT HOLDERS BE LIABLE FOR ANY CLAIM, DAMAGES OR OTHER LIABILITY, WHETHER IN AN ACTION OF CONTRACT, TORT OR OTHERWISE, ARISING FROM, OUT OF OR IN CONNECTION WITH THE SOFTWARE OR THE USE OR OTHER DEALINGS IN THE SOFTWARE.

### 13.4 EPL-1.0 License

THE ACCOMPANYING PROGRAM IS PROVIDED UNDER THE TERMS OF THIS ECLIPSE PUBLIC LICENSE ("AGREEMENT"). ANY USE, REPRODUCTION OR DISTRIBUTION OF THE PROGRAM CONSTITUTES RECIPIENT'S ACCEPTANCE OF THIS AGREEMENT.

#### 1. Definitions.

"Contribution" means:

- a) in the case of the initial Contributor, the initial code and documentation distributed under this Agreement, and
- b) in the case of each subsequent Contributor:
  - i) changes to the Program, and
  - ii) additions to the Program;

where such changes and/or additions to the Program originate from and are distributed by that particular Contributor. A Contribution 'originates' from a Contributor if it was added to the Program by such Contributor itself or anyone acting on such Contributor's behalf. Contributions do not include additions to the Program which: (i) are separate modules of software distributed in conjunction with the Program under their own license agreement, and (ii) are not derivative works of the Program.

"Contributor" means any person or entity that distributes the Program.

"Licensed Patents" mean patent claims licensable by a Contributor which are necessarily infringed by the use or sale of its Contribution alone or when combined with the Program.

"Program" means the Contributions distributed in accordance with this Agreement.

"Recipient" means anyone who receives the Program under this Agreement, including all Contributors.

#### 2. Grant of rights.

a) Subject to the terms of this Agreement, each Contributor hereby grants Recipient a non-exclusive, worldwide, royalty-free copyright license to reproduce, prepare derivative works of, publicly display, publicly perform, distribute and sublicense the Contribution of such Contributor, if any, and such derivative works, in source code and object code form.

b) Subject to the terms of this Agreement, each Contributor hereby grants Recipient a non-exclusive, worldwide, royalty-free patent license under Licensed Patents to make, use, sell, offer to sell, import and otherwise transfer the Contribution of such Contributor, if any, in source code and object code form. This patent license shall apply to the combination of the Contribution and the Program if, at the time the Contribution is added by the Contributor, such addition of the Contribution causes such combination to be covered by the Licensed Patents. The patent license shall not apply to any other combinations which include the Contribution. No hardware per se is licensed hereunder.

c) Recipient understands that although each Contributor grants the licenses to its Contributions set forth herein, no assurances are provided by any Contributor that the Program does not infringe the patent or other intellectual property rights of any other entity. Each Contributor disclaims any liability to Recipient for claims brought by any other entity based on infringement of intellectual property rights or otherwise. As a condition to exercising the rights and licenses granted hereunder, each Recipient hereby assumes sole responsibility to secure any other intellectual property rights needed, if any. For example, if a third party patent license is required to allow Recipient to distribute the Program, it is Recipient's responsibility to acquire that license before distributing the Program.

d) Each Contributor represents that to its knowledge it has sufficient copyright rights in its Contribution, if any, to grant the copyright license set forth in this Agreement.

### 3. Requirements.

A Contributor may choose to distribute the Program in object code form under its own license agreement, provided that:

- a) it complies with the terms and conditions of this Agreement; and
- b) its license agreement:
  - i) effectively disclaims on behalf of all Contributors all warranties and conditions, express and implied, including warranties or conditions of title and non-infringement, and implied warranties or conditions of merchantability and fitness for a particular purpose;
  - ii) effectively excludes on behalf of all Contributors all liability for damages, including direct, indirect, special, incidental and consequential damages, such as lost profits;
  - iii) states that any provisions which differ from this Agreement are offered by that Contributor alone and not by any other party; and
  - iv) states that source code for the Program is available from such Contributor, and informs licensees how to obtain it in a reasonable manner on or through a medium customarily used for software exchange.

When the Program is made available in source code form:

- a) it must be made available under this Agreement; and
- b) a copy of this Agreement must be included with each copy of the Program.

Contributors may not remove or alter any copyright notices contained within the Program.

Each Contributor must identify itself as the originator of its Contribution, if any, in a manner that reasonably allows subsequent Recipients to identify the originator of the Contribution.

### 4. Commercial distribution.

Commercial distributors of software may accept certain responsibilities with respect to end users, business partners and the like. While this license is intended to facilitate the commercial use of the Program, the Contributor who includes the Program in a commercial product offering should do so in a manner which does not create potential liability for other Contributors. Therefore, if a Contributor includes the Program in a commercial product offering, such Contributor ("Commercial Contributor") hereby agrees to defend and indemnify every other Contributor ("Indemnified Contributor") against any losses, damages and costs (collectively "Losses") arising from claims, lawsuits and other legal actions brought by a third party against the Indemnified Contributor to the extent caused by the acts or omissions of such Commercial Contributor in connection with its distribution of the Program in a commercial product offering. The obligations in this section do not apply to any claims or Losses relating to any actual or alleged intellectual property infringement. In order to qualify, an Indemnified Contributor must: a) promptly notify the Commercial Contributor in writing of such claim, and b) allow the Commercial Contributor to control, and cooperate with the Commercial Contributor in, the defense and any related settlement negotiations. The Indemnified Contributor may participate in any such claim at its own expense.

For example, a Contributor might include the Program in a commercial product offering, Product X. That Contributor is then a Commercial Contributor. If that Commercial Contributor then makes performance claims, or offers warranties related to Product X, those performance claims and warranties are such Commercial Contributor's responsibility alone. Under this section, the Commercial Contributor would have to defend claims against the other Contributors related to those performance claims and warranties, and if a court requires any other Contributor to pay any damages as a result, the Commercial Contributor must pay those damages.

### 5. No warranty.

EXCEPT AS EXPRESSLY SET FORTH IN THIS AGREEMENT, THE PROGRAM IS PROVIDED ON AN "AS IS" BASIS, WITHOUT WARRANTIES

OR CONDITIONS OF ANY KIND, EITHER EXPRESS OR IMPLIED INCLUDING, WITHOUT LIMITATION, ANY WARRANTIES OR CONDITIONS OF TITLE, NON-INFRINGEMENT, MERCHANTABILITY OR FITNESS FOR A PARTICULAR PURPOSE. Each Recipient is solely responsible for determining the appropriateness of using and distributing the Program and assumes all risks associated with its exercise of rights under this Agreement, including but not limited to the risks and costs of program errors, compliance with applicable laws, damage to or loss of data, programs or equipment, and unavailability or interruption of operations.

### 6. Disclaimer of liability.

EXCEPT AS EXPRESSLY SET FORTH IN THIS AGREEMENT, NEITHER RECIPIENT NOR ANY CONTRIBUTORS SHALL HAVE ANY LIABILITY FOR ANY DIRECT, INDIRECT, INCIDENTAL, SPECIAL, EXEMPLARY, OR CONSEQUENTIAL DAMAGES (INCLUDING WITHOUT LIMITATION LOST PROFITS), HOWEVER CAUSED AND ON ANY THEORY OF LIABILITY, WHETHER IN CONTRACT, STRICT LIABILITY, OR TORT (INCLUDING NEGLIGENCE OR OTHERWISE) ARISING IN ANY WAY OUT OF THE USE OR DISTRIBUTION OF THE PROGRAM OR THE EXERCISE OF ANY RIGHTS GRANTED HEREUNDER, EVEN IF ADVISED OF THE POSSIBILITY OF SUCH DAMAGES.

### 7. General.

If any provision of this Agreement is invalid or unenforceable under applicable law, it shall not affect the validity or enforceability of the remainder of the terms of this Agreement, and without further action by the parties hereto, such provision shall be reformed to the minimum extent necessary to make such provision valid and enforceable.

If Recipient institutes patent litigation against any entity (including a cross-claim or counterclaim in a lawsuit) alleging that the Program itself (excluding combinations of the Program with other software or hardware) infringes such Recipient's patent(s), then such Recipient's rights granted under Section 2(b) shall terminate as of the date such litigation is filed.

All Recipient's rights under this Agreement shall terminate if it fails to comply with any of the material terms or conditions of this Agreement and does not cure such failure in a reasonable period of time after becoming aware of such noncompliance. If all Recipient's rights under this Agreement terminate, Recipient agrees to cease use and distribution of the Program as soon as reasonably practicable. However, Recipient's obligations under this Agreement and any licenses granted by Recipient relating to the Program shall continue and survive.

Everyone is permitted to copy and distribute copies of this Agreement, but in order to avoid inconsistency the Agreement is copyrighted and may only be modified in the following manner. The Agreement Steward reserves the right to publish new versions (including revisions) of this Agreement from time to time. No one other than the Agreement Steward has the right to modify this Agreement. The Eclipse Foundation is the initial Agreement Steward. The Eclipse Foundation may assign the responsibility to serve as the Agreement Steward to a suitable separate entity. Each new version of the Agreement will be given a distinguishing version number. The Program (including Contributions) may always be distributed subject to the version of the Agreement under which it was received. In addition, after a new version of the Agreement is published, Contributor may elect to distribute the Program (including its Contributions) under the new version. Except as expressly stated in Sections 2(a) and 2(b) above, Recipient receives no rights or licenses to the intellectual property of any Contributor under this Agreement, whether expressly, by implication, estoppel or otherwise. All rights in the Program not expressly granted under this Agreement are reserved.

This Agreement is governed by the laws of the State of New York and the intellectual property laws of the United States of America. No party to this Agreement will bring a legal action under this Agreement more than one year after the cause of action arose. Each party waives its rights to a jury trial in any resulting litigation.

### 13.5 Eclipse Distribution License - v 1.0

Copyright (c) 2007, Eclipse Foundation, Inc. and its licensors.

All rights reserved.

Redistribution and use in source and binary forms, with or without modification, are permitted provided that the following conditions are met:

- Redistributions of source code must retain the above copyright notice, this list of conditions and the following disclaimer.
- Redistributions in binary form must reproduce the above copyright notice, this list of conditions and the following disclaimer in the documentation and/or other materials provided with the distribution.
- Neither the name of the Eclipse Foundation, Inc. nor the names of its contributors may be used to endorse or promote products derived from this software without specific prior written permission.

THIS SOFTWARE IS PROVIDED BY THE COPYRIGHT HOLDERS AND CONTRIBUTORS "AS IS" AND ANY EXPRESS OR IMPLIED WARRANTIES, INCLUDING, BUT NOT LIMITED TO, THE IMPLIED WARRANTIES OF MERCHANTABILITY AND FITNESS FOR A PARTICULAR PURPOSE ARE DISCLAIMED. IN NO EVENT SHALL THE COPYRIGHT OWNER OR CONTRIBUTORS BE LIABLE FOR ANY DIRECT, INDIRECT, INCIDENTAL, SPECIAL, EXEMPLARY, OR CONSEQUENTIAL DAMAGES (INCLUDING, BUT NOT LIMITED TO, PROCUREMENT OF SUBSTITUTE GOODS OR SERVICES; LOSS OF USE, DATA, OR PROFITS; OR BUSINESS INTERRUPTION) HOWEVER CAUSED AND ON ANY THEORY OF LIABILITY, WHETHER IN CONTRACT, STRICT LIABILITY, OR TORT (INCLUDING NEGLIGENCE OR OTHERWISE) ARISING IN ANY WAY OUT OF THE USE OF THIS SOFTWARE, EVEN IF ADVISED OF THE POSSIBILITY OF SUCH DAMAGE.

---

## 14 Technical terms

### App

A mobile application, or app for short, is a software application, which has been developed for operation on a smartphone, tablet or other hand-held electronic device. Apps are used to add functions simply to a mobile device, so that it becomes a multifunctional communication device.

### Bosch server

A central server, with which EasyControl is in contact.

### CH

Central heating.

### DHW

Domestic hot water.

### EMS

Bosch protocol language.

### iRT

A communication protocol, which is used in a heating system between a heat source and a controller (intelligent Room Thermostat).

### OpenTherm

A communication protocol, which is used in a heating system between a heat source and a controller.

### Smart Device

An electronic device, which can generally be connected via various types of wireless networks to other electronic devices, such as smartphones, tablets, room thermostats etc.

### Thermostatically controlled radiator valve

A heat-sensitive element is located within the controller. In cold weather this opens, and warm boiler water flows to the radiator. As the heat increases, the element closes and less hot water flows to the radiator.

### WLAN network

Technology for wireless communication.

### WLAN amplifier

Electronic device, which resends the existing signal of a WLAN network.

[www.bosch-easycontrol.com](http://www.bosch-easycontrol.com)

