

AQUALISA

OPTIC Q™

OPQ.A2.BV.
DVFW.20

WITH ADJUSTABLE HEAD AND WALL FIXED DRENCHER - GRAVITY PUMPED

DIMENSIONAL DRAWINGS

FIXED WALL DRENCHER

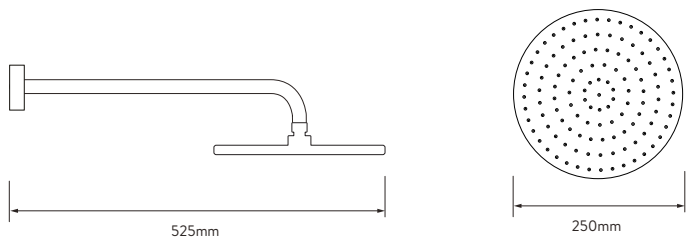

CONTROLLER

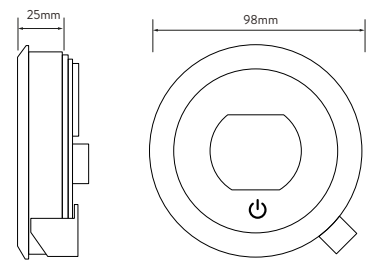

SHOWER RAIL KIT

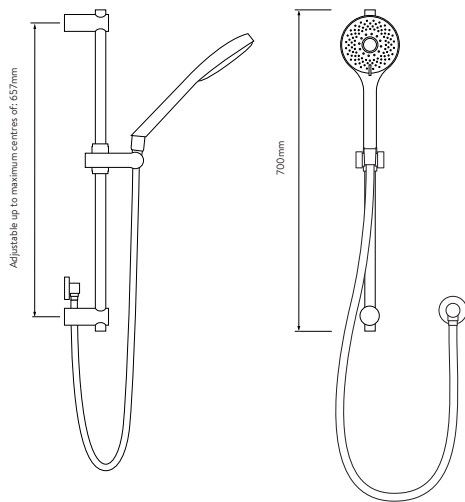

SHOWER HEAD

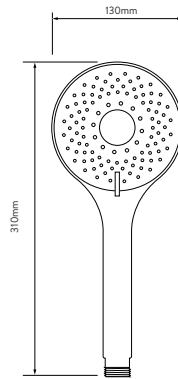

AQUALISA SMARTVALVE™

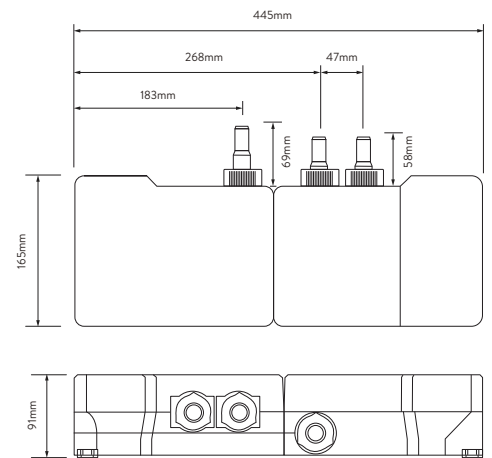

SHOWER HOSE

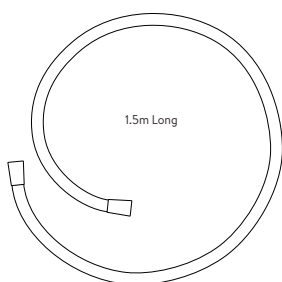

DIVERTER

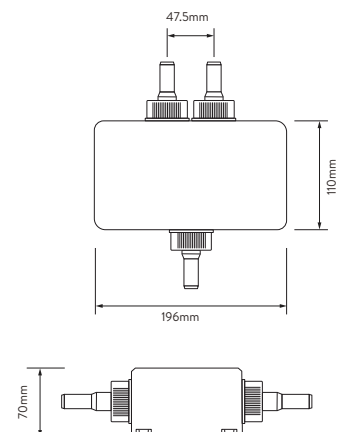

WITH ADJUSTABLE HEAD AND WALL FIXED DRENCHER - GRAVITY PUMPED

TECHNICAL SPECIFICATIONS

Minimum pressure requirements	Aqualisa SmartValve™ must be sited no higher than the base level of the cold water system
Maximum pressure requirements	1 bar (Gravity)
Aqualisa SmartValve™ inlet fitting connections	15mm push fit fittings, valve inlet centres 48mm, inlet supply positions – hot right, cold left
Aqualisa SmartValve™ and diverter outlet connections	15mm push fit
Permissible Aqualisa SmartValve™ and diverter siting locations	Loft, airing cupboard, under bath
Supply temperature	Cold inlet temperature 1°C (minimum) Cold inlet temperature 15°C (maximum) Hot inlet temperature 65°C (maximum)
Water system	Gravity
Features	Proximity sensor (to wake controller up)
	Large rotary temperature ring
	Digital display system
	User definable shower profiles / experiences (available via the Aqualisa app)
	Warm and ready indicator
	Optical on off switch
	Unique Q™ lever control
	Magnetically damped Q™ lever
	130mm Vita™ shower head with 3 spray patterns
	Wi-Fi & App compatible – control your product with your smart phone and smart home device e.g. Alexa
	App functions include start/stop, set your flow and temperature, shower timer, user dashboard, usage tracker and help & support
	Aqualisa SmartValve™
	Optional wireless rechargeable remote control
	You can select the shower outlet you want to start first everytime
Digital diverter technology	
Guarantee period	5-year guarantee - shower unit
	2-year guarantee - shower head and kit
Approvals	CE Marking
	BEAB

Check out our full range of Showers

Electric Showers

Digital Showers

Mixer Showers

Power Showers

Smart Showers

Shower Towers

From Top Shower Brands

Mira Showers

Aqualisa Showers

Triton Showers

Gainsborough Showers

Shower Pumps can upgrade your showering experience even more

Stuart Turner Shower Pumps

Salamander Shower Pumps

Grundfos Shower Pumps

plumbworld
Big brands, small prices.