

STUART TURNER LTD HENLEY-ON-THAMES.

THIRD ANGLE PROJECTION

DIMENSIONS IN MILLIMETRES

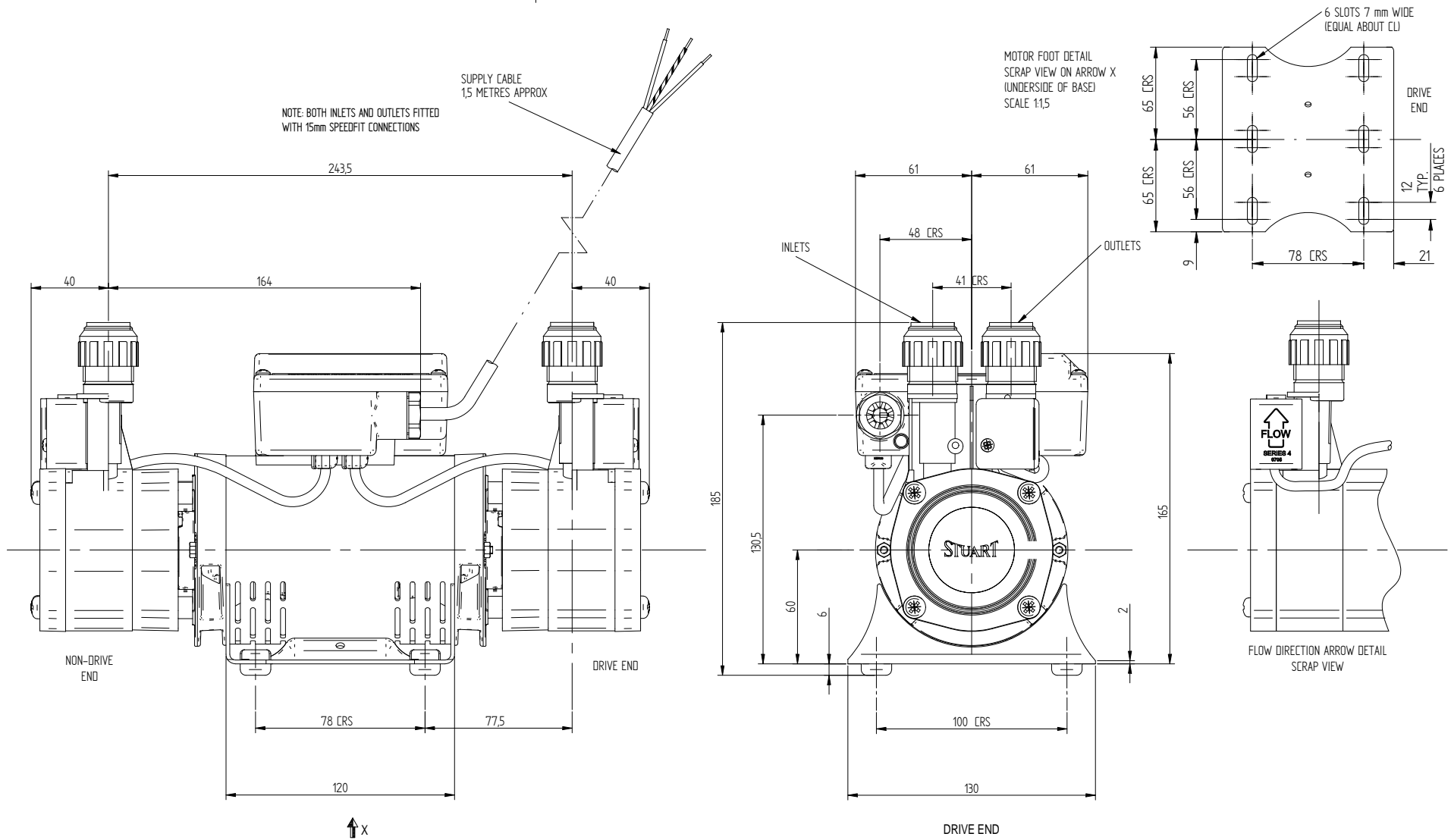

If drawing is to be used for constructional purposes please contact Stuart Turner Ltd and request a certified document.

Stuart Turner Ltd reserves the right to amend specifications without notice.

Stuart Turner Ltd own the copyright within this document. The document may be printed for personal use only. The document must not be altered, reproduced or utilized in any way without written permission from Stuart Turner Ltd, Henley-on-Thames, Oxon, UK.

GENERAL ARRANGEMENT OF A SHOWERMATE 2.0 bar TWIN

W41222

DATE: 29/04/08

Check out our full range of Showers

Electric Showers

Digital Showers

Mixer Showers

Power Showers

Smart Showers

Shower Towers

From Top Shower Brands

Mira Showers

Aqualisa Showers

Triton Showers

Gainsborough Showers

Shower Pumps can upgrade your showering experience even more

Stuart Turner Shower Pumps

Salamander Shower Pumps

Grundfos Shower Pumps

plumbworld
Big brands, small prices.