

CUSTOMER SERVICE

Guarantee

Your product has the benefit of our manufacturer's guarantee which starts from the date of purchase. To activate this guarantee, please return your completed registration card, visit our website or free phone 0800 0731248 within 30 days of purchase (UK only).

Within the guarantee period we will resolve defects in materials or workmanship, free of charge, by repairing or replacing parts or product as we may choose.

This guarantee is in addition to your statutory rights and is subject to the following conditions:

- The guarantee applies solely to the original installation under normal use and to the original purchaser only. The product must be installed and maintained in accordance with the instructions given in this user guide.
- Servicing must only be undertaken by us or our appointed representative. **Note!** if a service visit is required the product must be fully installed and connected to services.
- Repair under this guarantee does not extend the original expiry date. The guarantee on any replacement parts or product ends at the original expiry date.
- For shower fittings or consumable items we reserve the right to supply replacement parts only.

The guarantee does not cover:

- Call out charges for non product faults (such as damage or performance issues arising from incorrect installation, improper use, inappropriate cleaning, lack of maintenance, build up of limescale, frost damage, corrosion, system debris or blocked filters) or where no fault has been found with the product.
- Water or electrical supply, waste and isolation issues.
- Compensation for loss of use of the product or consequential loss of any kind.
- Damage or defects caused if the product is repaired or modified by persons not authorised by us or our appointed representative.
- Routine maintenance or replacement parts to comply with the requirements of the TMV 2 or TMV 3 healthcare schemes.
- Accidental or wilful damage.
- Products purchased ex-showroom display.

What to do if something goes wrong

If your product does not work correctly refer to this manual for fault diagnosis and check that it is installed and commissioned in accordance with our instructions. If this does not resolve the issue, contact us for help and advice.

Extended Guarantees

A selection of protection plans are available that enable you to cover repair bills (excludes Eire). Ring 01922 471763 for more details.



Helpdesk Service - Ring our Customer Services Team for product advice, to purchase spare parts or accessories or to set up service visit. You can contact us via phone or e-mail, details below. Please provide your model name, power rating (if applicable) and date of purchase.



Mira Showers Website (www.mirashowers.co.uk)

Visit our website to register your guarantee, download user guides, diagnose faults, purchase our full range of accessories and popular spares, or request a service visit.



Spares and Accessories - We hold the largest stocks of genuine Mira spares and accessories. Contact us for a price or visit our website to purchase items from our accessory range and popular spares.



Service/Repairs - No one knows our products better than our nationwide team of Service Technicians. We can carry out service or repair work to your product both during and after the guarantee period. Ask about our fixed price service repairs.

To Contact Us: UK



0844 571 5000



Fax: 01 242 282595



E-mail: Visit www.mirashowers.co.uk/contactus



Mira Customer Services Dept, Cromwell Road, Cheltenham, Gloucestershire, GL52 5EP

To Contact Us: Eire Only



01 459 1344



Fax: Dublin 01 459 2329



E-mail: sales@modernplant.ie



Modern Plant Ltd (Dublin), Otter House, Naas Road, Clondalkin, Dublin 22

Mira Beat 200 mm Deluge Overhead (1799.001 - Chrome)
 Mira Beat 200 mm Deluge Overhead (1799.002 - White)
 Mira Beat 250 mm Deluge Overhead (1799.003 - Chrome)
 Mira Beat 250 mm Deluge Overhead (1799.004 - White)
 Mira Wall-fed Fixed Head Arm (1799.005)

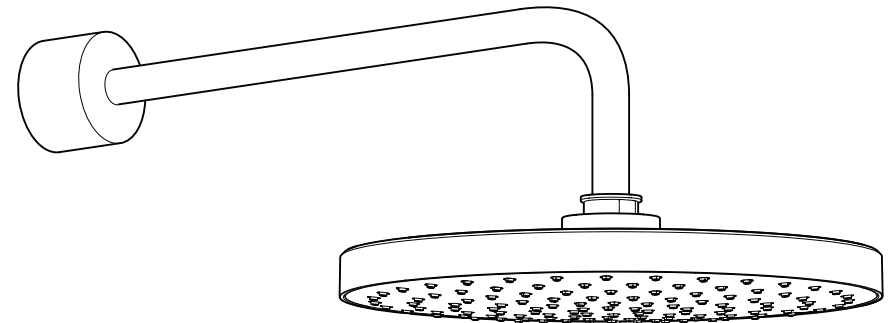

These instructions must be left with the user

Installation and User Guide

Showering perfection

mira
SHOWERS

Mira is a registered trade mark of Kohler Mira Limited.

The company reserves the right to alter product specifications without notice.



INTRODUCTION

Thank you for purchasing a quality Mira product. To enjoy the full potential of your new product, please take time to read this guide thoroughly, having done so, keep it handy for future reference.

These shower fittings are designed to give a satisfactory shower over a range of pressures between 0.1 and 5.0 bar.

The Mira Shower Fittings have been designed for domestic use only, Mira Showers guarantee the fittings against any defect in materials or workmanship for a period of one year from the date of purchase.

For non-domestic installations, Mira Showers guarantee the fittings against any defect in materials or workmanship for a period of one year from the date of purchase.

For terms and conditions, refer to the back cover of this guide.

INSTALLATION

General

1. Make sure that the shower fittings are installed by a competent installer.
2. Installations must comply with Water Regulations (Bye-Laws, Scotland), and any other Local Regulations and Building Regulations in force at the time of installation.
3. Before installation carefully inspect the new fixture for any signs of damage.
4. The shower fittings should be positioned at a convenient height for all the family and so that the deluge head will discharge down the centre of a bath or shower cubicle. Position the deluge head to spray across rather than towards the opening of the cubicle (if applicable) and also away from the shower control.
5. Special consideration should be given to the fixing arrangements when installing onto a dry lined, stud partition, shower cubicle or laminated panel wall structures. Installers may wish to obtain alternative proprietary cavity fixings, or choose other options, however, these methods of fixing are beyond the scope of this guide.

Install the Shower Arm and Showerhead

The shower arm and showerhead must be fitted after the installation of the shower control and the outlet pipe must protrude 18 mm (± 2 mm) from the finished wall surface. The outlet pipe must be fitted at a suitable height and so that the showerhead will discharge down the centre of a bath or shower cubicle.

1. Mark the positions of the backplate fixing holes.
Caution! Be aware of hidden pipes or cables.
2. For solid walls drill the fixing holes for the backplate with a 6 mm drill and insert the wall plugs (supplied). For other types of wall structure alternative fixings may be required (not supplied).
Caution! Take care not to drill into hidden pipes or cables.
3. Carefully fit the backplate over the outlet pipe and secure with the fixing screws (supplied).
Caution! Take care not to damage the 'O' Seal in the back of the backplate.

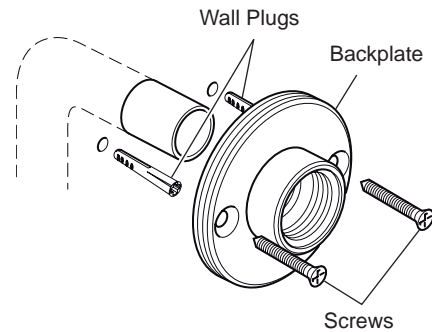

4. Fit the olive and compression nipple over the outlet pipe and tighten the compression nipple.

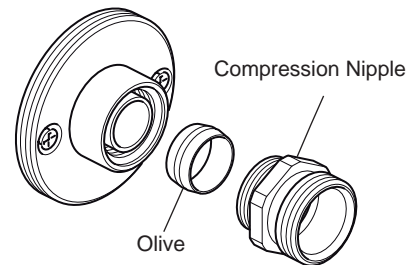

5. Fit the concealing shroud onto the shower arm.
6. Fit the compression nut and olive onto the shower arm.
7. Fit the shower arm into the compression nipple and tighten the compression nut.

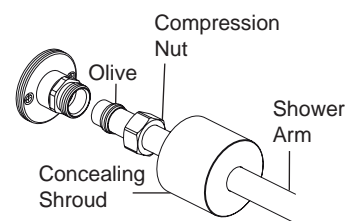

8. Hand tighten the concealing shroud onto the backplate.
9. Screw the overhead onto the shower arm, if necessary fit the flow regulator.
Important! Certain mixing valves may have flow regulators, refer to your shower control installation and user guide for details.
Caution! The shower arm is not designed to take weight, therefore care needs to be taken when installing the showerhead.

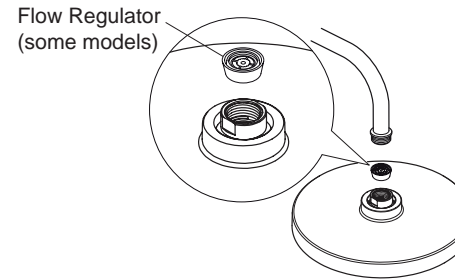

Alternative Installation procedure using the wallplate

1. Loosely screw the backplate to the wallplate with the two backplate screws provided.
2. Place the wallplate and backplate assembly over the copper pipe.
3. Mark the position of the wallplate and its fixing holes on the wall.

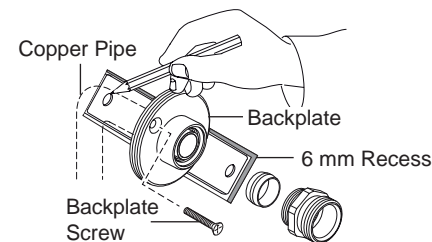

4. Remove the screws and backplate from the wallplate.
5. Drill the two backplate fixing holes, if necessary make a recess approximately 6 mm deep to accept the wallplate. Plug the two fixing holes.
6. Place the wallplate over the copper pipe and fix to the wall with the two wallplate screws.

7. Temporarily fit the two backplate screws to the wallplate. This will prevent the holes from becoming blocked with plaster and grout.
8. Finish the surface of the wall as required ensuring the pipework is protruding by 18 mm \pm 2 mm.
9. Remove the two backplate screws.
10. Place the backplate against the finished wall surface and use the two backplate screws supplied to fix the backplate to the wallplate.
11. Follow steps 4 - 9 from previous section to complete the shower arm installation.

MAINTENANCE

Cleaning

Warning! Many household cleaners contain abrasive and chemical substances, and should not be used for cleaning plated or plastic fittings.

These finishes should be cleaned with a mild washing up detergent or soap solution, and then wiped dry using a soft cloth.

Use your thumb or a soft cloth to wipe any limescale from the soft nozzles and the front surface of the showerhead spray plate.

Do not use descalents on this product.

SPARE PARTS

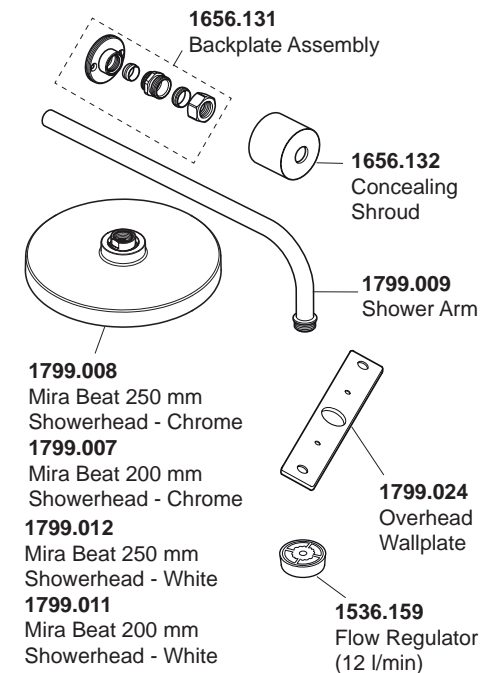

Check out our full range of Showers

Electric Showers

Digital Showers

Mixer Showers

Power Showers

Smart Showers

Shower Towers

From Top Shower Brands

Mira Showers

Aqualisa Showers

Triton Showers

Gainsborough Showers

Shower Pumps can upgrade your showering experience even more

Stuart Turner Shower Pumps

Salamander Shower Pumps

Grundfos Shower Pumps

plumbworld
Big brands, small prices.