

AQUALISA

Dream[®]

**Thermostatic mixer shower with 105mm
Harmony head**

Installation guide



Introduction	p.3
- Safety information	p.3
- Product specification	p.3
Connection to supplies	p.3
- Pipe sizing	p.3
- Flushing	p.4
- Filters	p.4
- Isolating valves	p.4
- Pressures	p.4
Gravity system	p.4
- Siting	p.5
- Pump installation	p.5
- Stored water capacities	p.5
Combination boiler systems	p.5
Balanced high pressure systems	p.5
Typical water systems	p.6
System components	p.8
Valve installation instructions	p.9
- Dream concealed valve	p.9
Harmony shower head installation	p.12
- Adjustable height Harmony head	p.12
- Fixed Harmony head	p.15
User guide	
- Shower valve	p.16
- Adjustable height Harmony head	p.16
- Fixed Harmony head	p.17
Cleaning & maintenance	p.17
Commissioning	p.18
Trouble shooting guide	p.19

Introduction

The Dream product range includes a concealed valve available complete with either an adjustable height or fixed shower head. Dream thermostatic valves provide close temperature stability and fail safe protection on appropriate high and low pressure systems. Please refer to the product specification section below.

If at any stage during installation you have any questions, please contact the Aqualisa customer helpline on 01959 560010 for assistance.

Safety information

This product must be installed by a competent person in accordance with all relevant current Water Supply Regulations.

THE SHOWER MUST NOT BE USED WITH A HOT WATER SUPPLY TEMPERATURE OVER 65°C.

The Dream range is designed for domestic use only.

Product specification

Dream products are suitable for all gravity, boosted gravity, balanced high pressure and combination boiler systems*. Pressure range 0.1bar – 10bar max (static).

*The combination boiler MUST have a minimum rating of 24kW (80,000 Btu) and be of the type fitted with a fully modulating gas valve.

A cold inlet flow regulator is provided for use with combination boiler applications.

If any doubt, please contact the appliance manufacturer before installation commences.

Connections

Dream products are designed for conventional supplies with HOT on the left and COLD on the right as viewed from the front.

Dream shower valves incorporate 'push fit' type connections for use with 15mm British standard copper tube. Tube should be cut using a rotary type cutter and lubricated using a silicone based lubricant or petroleum jelly (Vaseline or similar) prior to insertion into the fitting.

If plastic pipe is used, the tube insert must not increase the tube diameter or extend the cut off length by more than 2mm.

THESE FITTINGS ARE NOT SUITABLE FOR STAINLESS STEEL TUBE.

Supply lines must be flushed clear of any debris before installation of the unit. Any debris accumulation in the in the shower valve and head may result in damage and poor performance.

Pipe sizing

Long pipe runs, on both inlet and outlet, will reduce the flow rate at the shower head. If long pipe runs are unavoidable, use copper pipe rather than plastic. If plastic pipe is used, minimise the number of elbows as pipe inserts are very restrictive. Consideration should be given to using 22mm plastic or copper pipe especially if a diverter valve is to be fitted.

Flushing

Some modern fluxes can be extremely corrosive and, if left in contact, will attack the working parts of the unit. All soldering must be completed and the pipe work thoroughly flushed out in accordance with current Water Supply Regulations prior to connection of the product.

Filters

To ensure ongoing optimum performance, the internal control mechanism 'cartridge' is protected by a two-part filter system. Debris accumulation may result in reduced flow from the shower head and noisy operation.

As this condition is not covered by our standard warranty terms, it is suggested that the cartridge be removed and the filters checked by a competent person. In the event of any difficulties please contact the Aqualisa customer helpline for assistance.

Isolating valves

Suitable full way isolation valves must be fitted to both supplies in accordance with current Water Supply Regulations and our terms of warranty.

Due to their restrictive characteristics, stopcocks and ball type valves that reduce the pipe bore size must not be used on gravity and boosted gravity installations.

Pressures

The Dream cartridge is designed to operate from the mains at a maximum of 10bar. If the mains pressure likely to exceed 10bar, a 'drop tight' PRV must be fitted on the supply pipe after the main stopcock. A setting of 3bar is recommended. It should be noted that daytime pressures approaching 8bar can rise above the stated maximum overnight.

A suitable PRV is available from Aqualisa.

Dream products are not suitable for mixed supply systems, e.g. gravity hot and mains cold.

Gravity fed hot and cold supplies

Services must be installed according to good plumbing practice having regard to pipe sizing, long pipe runs and low head situations.

The cold supply for the valve assembly must be taken directly from the cold water storage system. The hot supply may be taken from the vent/draw off pipe of the hot water cylinder at a point below the cylinder connection or alternatively from the underside of the horizontal draw off.

Rising pipe work must NOT be connected into the horizontal draw off from the cylinder or to any point in the vent/draw off pipe above the cylinder connection.

CYLINDER TEMPERATURE IN EXCESS OF 65°C MAY RESULT IN POOR SHOWER PERFORMANCE

To minimise pressure loss we recommend that the hot and cold supplies are run in 22mm as close as reasonably possible to the mixing valve before reducing to 15mm.

Siting

For optimum performance, with gravity fed systems the distance between the bottom of the storage cistern and the shower head should be not less than 1m (when using an adjustable height head). If using a fixed head, the highest point of the pipe work must be below the underside of the cistern.

Please refer to the typical system layout on page 6.

Pump installation

UNDER NO CIRCUMSTANCES MUST A PUMP BE FITTED DIRECTLY TO THE WATER MAIN

A pump must only be used to boost the pressure from tank fed supplies.

A minimum 1 bar twin ended booster pump is recommended.

ENSURE THE MINIMUM GRAVITY FLOW RATE IS SUFFICIENT TO OPERATE THE PUMP FLOW SWITCHES.

PLEASE REFER TO THE MANUFACTURERS PUMP INSTALLATION GUIDE FOR PUMP INSTALLATION INFORMATION.

Please refer to the typical system layout on page 6.

Stored water capacities

The minimum capacity of the cold storage cistern should be not less than 225 litres (50 gallons). The capacity of the hot cylinder must be capable of meeting the anticipated demand.

Combination boiler/multipoint system

Dream products are suitable for use with combination boiler systems. The combination boiler **MUST** have a minimum rating of 24kW (80,000 Btu) and be of the type fitted with a fully modulating gas valve. This is sufficient to operate one outlet at a time.

If in any doubt, please contact the appliance manufacturer before installation commences.

The cold supply can be taken from the nearest convenient mains supply and the hot supply can be taken from the nearest hot water draw off point. Account must be taken of the pressure drops that will occur when other draw off points are used while the shower is in use.

Please refer to the typical system layout on page 7.

Balanced high pressure system

The cold water supply must be drawn from the same mains supply as that to the hot water system (down stream of the cylinder manufacturer's pressure limiting valve, where supplied) and the hot supply from the nearest convenient draw off point. Account must be taken of pressure drops that may occur when other draw off points are used while the shower is in use.

Please refer to the typical system layout on page 7.

Typical system diagrams

Typical gravity system installation

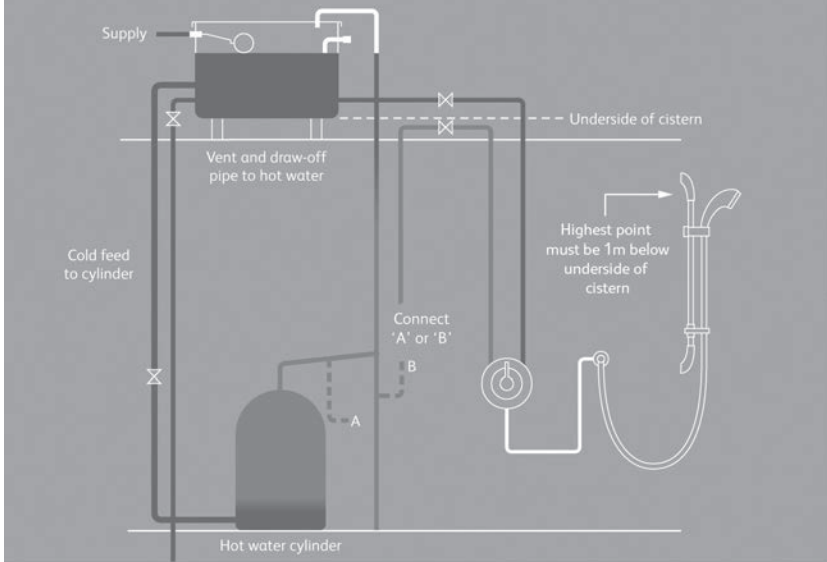

Typical pumped system installation

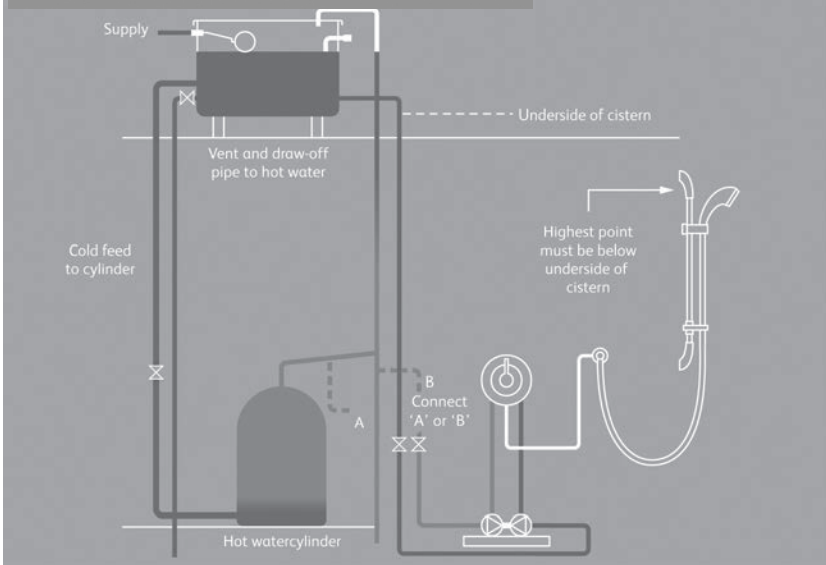

Typical system diagrams continued

Typical combination boiler system installation

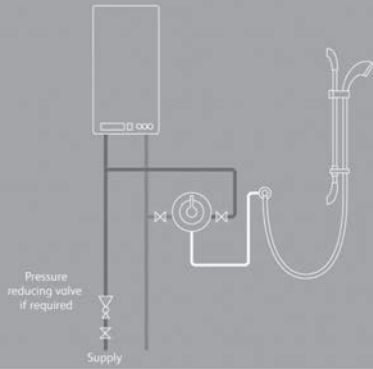

Typical UHW system installation

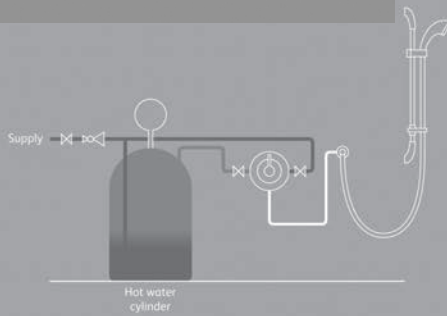

Typical thermal storage unit system installation

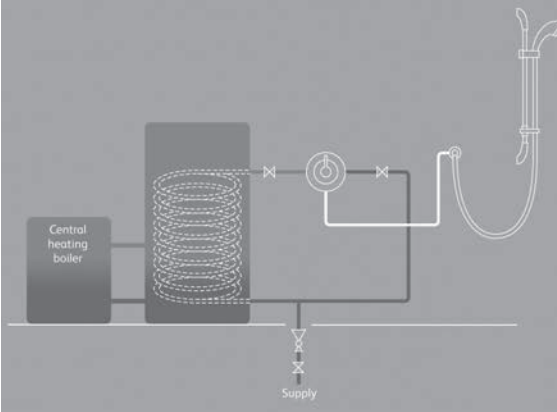

Components - Dream concealed with adjustable 105mm Harmony head

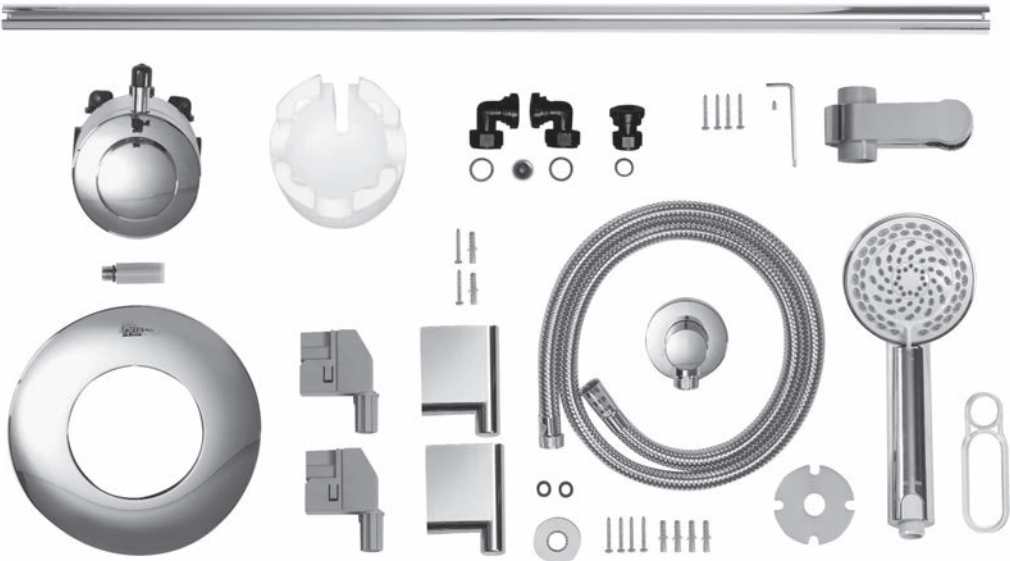

Components - Dream concealed with fixed 105mm Harmony head

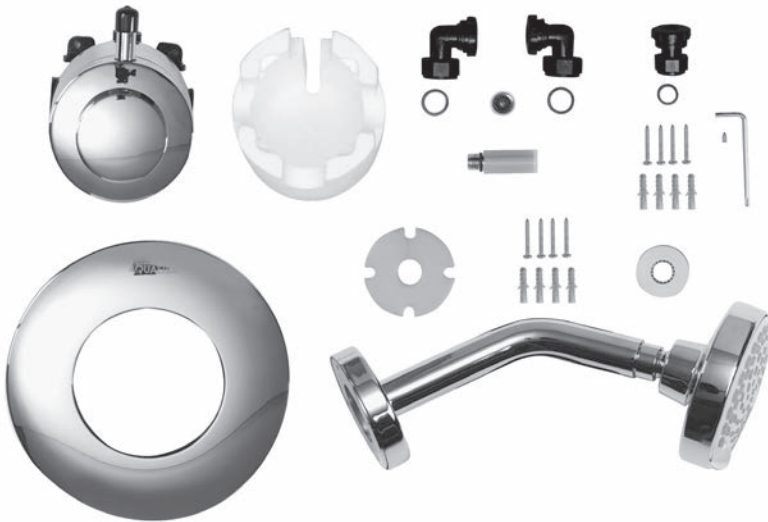

Dream concealed valve installation

! In addition to the guide below it is essential that the written instructions overleaf are read and understood and that you have all the necessary components (shown on page 8) before commencing installation. Failure to install the product in accordance with these instructions may adversely affect the warranty terms and conditions. Do not undertake any part of this installation unless you are competent to do so. Prior to starting ensure that you are familiar with the necessary plumbing regulations required to install the product correctly and safely.

Dream concealed is supplied with universal fixings.

- 1** If installing the product built in to a solid wall, chase out a suitable recess in the wall to receive the valve and pipe work. If installing the valve in a concealed panel mounted situation, in most cases it will be necessary to first install a suitable sound fixing in the cavity area before fixing the valve. A hole of $\text{Ø}130\text{mm}$ is required to install the valve and gain access to inlet and outlet connectors.

The valve needs to be mounted to the depth shown at the following centres.
The distance between the 15mm inlet centre pipe centres is 150mm as shown.

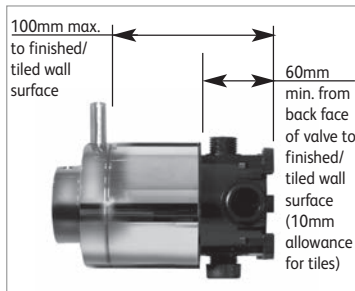
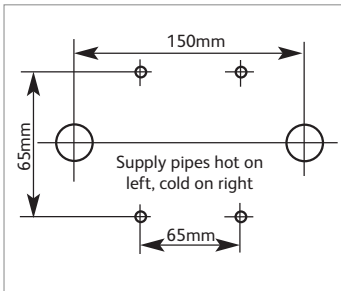

- 2** Mark the position for the four fixing points as outlined above.

- 3** Carefully remove the valve from its packaging and retain the mortar guard for later use.

- 4** Carefully remove the on/off knob from the valve assembly and set aside.



5 Ensuring the black protective cap remains fitted, set the temperature control lever to the full cold (9 o'clock) position. Remove the fixing screws, pull the assembly clear and set aside.

6 The temperature preset override ring (coloured) and the temperature preset location ring (white) do not need to be removed for installation. If they are removed however, please take note of the orientation prior to removal.



7 Carefully remove the shroud from the valve assembly. The temperature override housing (white) does not need to be removed in order for the valve to be installed. If the housing is removed then please take note of its orientation on the valve.



8 Fit the elbows to the body hand tight, ensuring that the rubber washers are correctly engaged (these are supplied in the screw pack).

9 If the valve is to be installed for use with a gas fired instantaneous (multipoint) water heater or a combination boiler the cold water flow regulator must be fitted at this stage by insertion into the cold water port as shown ensuring the o'ring faces the incoming flow (the flow regulator is supplied in its own pack).



10 The Dream valve is supplied with an outlet cap on the bottom of the valve allowing for a top outlet connection. The bottom outlet can be used by simply removing the cap and repositioning it on the top outlet. If the cap is removed please ensure that when replaced the washer in the cap is in place and that the cap is done up tight.

11 Fit the outlet connector ensuring that the rubber washer is correctly engaged (supplied in the screw pack), on the required outlet ensuring a tight fit. Position the valve and check the four fixing positions and that there is adequate space available around both inlet elbows and the outlet connector. Prepare the wall fixings as required. Secure the valve assembly to the fixing surface using the screws provided (if suitable).



12 Using a silicone-based lubricant, lubricate the supply pipe ends and whilst supporting the elbows push home the supply pipes ensuring the correct orientation for the inlet pipes (HOT left and COLD right as shown on the valve). Push the valve fully home until a definite stop is reached. Tube insertion depth is 25mm (1”).



13 Using a suitable tool, tighten both the elbow nuts and the outlet connector nut until water tight.

14 The installation should now be checked for leaks. Cap off the outlet assembly. Loosely fit the on/off lever assembly and turn it fully clockwise to ensure that the valve is fully turned off.

! **The on/off shaft is manufactured with a flat area. The corresponding flat area in the on/off lever must be in alignment before the knob can be fitted.**



15 Turn on the supply and check for any leaks upstream of the valve. Slowly open the control and check for leaks downstream of the valve. If all is sound, again turn the on/off control fully clockwise and turn off the supply.

16 Place the mortar guard around the valve and fill in the chase. Once the in-filling material has set, carefully remove the polystyrene to expose the valve body.

! **THE MORTAR GUARD MUST BE USED**



17 Refit the temperature preset override ring (coloured) and the temperature preset location ring (white) if removed prior to installation, taking care to fit the override ring in the correct orientation as outlined in step 6. Before replacing the shroud ensure that the shroud seal is in the correct position as shown.

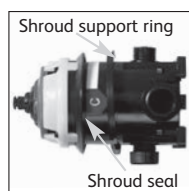

18 Replace the shroud ensuring that it is fully fitted against the shroud support ring as shown.



- 19** Using a silicone-based lubricant, petroleum jelly or liquid soap, lubricate the wall plate seal. Apply a thin bead of silicone mastic into the groove on the rear of the wall plate and carefully push the wall plate into position ensuring correct horizontal alignment of the Aqualisa logo.



- 20** Ensuring the red spacer ring is correctly fitted inside the temperature lever assembly, offer the lever assembly onto the valve, with the lever in the full cold (9 o'clock) position. Secure using the temperature lever screws hand tight only.



- 21** Refit the on/off knob onto the valve ensuring the correct alignment with the shaft as detailed in step 14. Using the grub screw and hexagonal key provided, secure the knob to the valve.



- 22** Secure the lever to the on/off knob assembly.



- 23** Remove the protective caps from the on/off and temperature levers.

Adjustable Harmony head installation

- 1** Prepare pipework from the shower valve to the required position for the hose outlet using a Ø15mm copper pipe. Slide the wall spacer down the projecting pipe flush with the finished wall surface.



- 2** Slide the 15mm gripper ring down the projecting pipe flush with the wall spacer fitting.



- 3** Trim the projecting pipe to a length of 15-20mm, measured from the front face of the grip ring, using a rotary type cutter. If a hacksaw is used, the pipe end must be carefully de-burred and chamfered.

- 4** Clean and lubricate the pipe using a suitable (silicone based) lubricant.

- 5** Remove the locking screw, rotate the chrome outlet assembly and remove the outlet from the wall mounting plate.

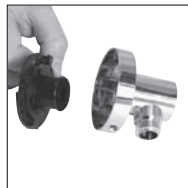

- 6** Place the wall outlet mounting plate onto the pipe assembly and mark and prepare the fixing points, using the fixings provided, if suitable.



- 7** Secure the wall mounting plate to the wall using the screws provided, if suitable.

- 8** Place the wall outlet onto the mounting plate, with the hose connection in the 5 o'clock position and rotate clockwise until a stop is reached.



- 9** Refit the locking screw taking care not to overtighten.



10 Drill and plug 2 holes $776 \pm 3\text{mm}$ apart using the fixings provided, if suitable.

11 Fix the bottom rail bracket into position using the screws provided, if suitable.

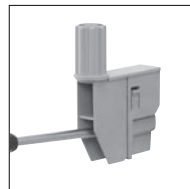

12 Pass the rail through the handset holder while keeping the slider rail depressed.

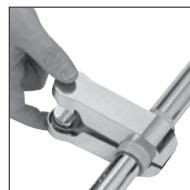

13 Carefully slide the gel hook onto the rail under the handset holder.



14 Current water supply regulations state that the handset should not be allowed to pass a point 25mm above the spill over level of the bath or shower tray. If this cannot be achieved, the hose must be passed through the gel hook which has also been designed to be utilised as a hose restraint.

15 Place the rail assembly onto the bottom fixing bracket taking care to engage the rail location slots on the bracket lugs.



16 Place the top fixing bracket into position and secure to the wall using the screws provided, if suitable.

17 Slide the rail end covers onto the rail brackets and click into position.

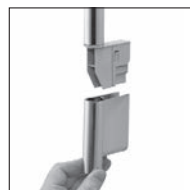

18 Pass the hose through the gel hook.

19 Ensuring the hose washers are in the correct position, depress the anti-swivel locking button on the handset and secure the handset to the hose. Connect the hose to the outlet connection and place the handset into the handset holder.



Fixed Harmony head installation

1 Prepare pipework from the shower valve to the required position for the fixed shower head using a Ø15mm copper pipe. Slide the wall spacer down the projecting pipe flush with the finished wall surface.



2 Slide the 15mm gripper ring down the projecting pipe flush with the wall spacer fitting.

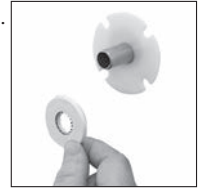

3 Trim the projecting pipe to a length of 20-50mm, measured from the front face of the grip ring, using a rotary type cutter. If a hacksaw is used, the pipe end must be carefully de-burred and chamfered.

4 Clean and lubricate the pipe using a suitable (silicone based) lubricant.

5 Carefully slide the fixed head cover plate down the fixed head arm taking care not to damage the plating.

6 Offer the fixed head arm into position over the pipework assembly and mark and prepare the fixing points using the fixings provided, if suitable.



- 7** Secure the head to the wall using the screws provided, if suitable.



- 8** Slide the cover plate into position flush with the finished wall surface.



User guide - Dream valve

Shower valve user guide

1. Turn the on/off lever fully anti-clockwise into the open position to turn the shower on.

N.B. The on/off knob MUST NOT be used as a method of flow control.

2. Rotate the temperature control lever, depressing the maximum temperature stop button at the top of the lever if required, to select a comfortable showering temperature using the temperature markings as a guide.

3. Turn the on/off lever fully clockwise into the closed position after use.



User guide - Adjustable height Harmony head

Adjustable head user guide

1. Rotate the sprayplate lever clockwise or anti-clockwise to select the desired spray pattern.

N.B. When the lever is in the 3 o'clock position when viewed from below, the water saving mode is selected. This provides the same spray pattern as position 3 but, depending on the water system the product is fitted to, offers up to 25% water saving.

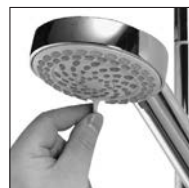

2. To select the preferred height for the shower head, depress the levers fully to enable the slider to be moved up or down the rail.



3. Angular adjustment is made by carefully but firmly pulling forwards or pushing back the shower head against the knuckle ratchet in the holder.



User guide - Fixed Harmony head

Fixed head user guide

1. Rotate the sprayplate lever clockwise or anti-clockwise to select the desired spray pattern.

N.B. When the lever is in the 3 o'clock position when viewed from below, the water saving mode is selected. This provides the same spray pattern as position 3 but, depending on the water system the product is fitted to, offers up to 25% water saving.



2. The angle of the fixed shower head can be adjusted. The shower head is mounted on a multi directional ball joint to allow for angular adjustment in any direction by carefully moving the shower head to the desired angle.



Cleaning and maintenance

Once a week with the shower valve fully open, we recommend turning the temperature control lever from full cold through to full hot several times to activate the internal valve anti-scale mechanism.

Your Aqualisa shower system should be cleaned using only a soft cloth and washing up liquid.

DO NOT USE ABRASIVE CLEANERS.

To reduce the requirement for chemical descaling in hard water areas, the shower heads incorporate soft rub clean teats. Any scale build that may occur in any of the holes can be broken down by gently rubbing the flexible tips of the jets during use.

Should chemical descaling of the head become necessary remove the shower head and fully immerse the shower rose in a mild proprietary descaler.

It is imperative that descaling is carried out strictly in accordance with the manufacturer's instructions.

Commissioning – Dream concealed

The Dream concealed valve is pre-set to a safe maximum shower temperature. During use, the action of the stop button may be overridden by depressing it as the temperature control is rotated. Should it be necessary to reset the maximum temperature position please observe the following procedures.

1. Ensure that the hot water system is at normal maximum temperature.
2. Turn the temperature control lever to the full cold position (9 o'clock).
3. Carefully remove the on/off control lever and set aside.
4. Loosen the grub screw within the on/off knob using the hexagonal key provided and pull the knob clear.
5. Remove the temperature control lever screws and pull the lever clear.
6. Carefully remove the coloured pre-set override ring and re-set in the appropriate direction to increase (clockwise) or decrease (anti-clockwise) the temperature where the override button needs to be pressed.
7. Depress the stop button and replace the temperature lever in the full cold position. Push the on/off knob into position fully home, but do not secure with the grub screw at this stage.
8. Test the shower by turning it on and slowly increasing the temperature, at the selected point, the button should pop up and prevent further movement.
9. Repeat the above process if the maximum temperature stop button needs further adjustment.
10. Follow steps 20 to 22 on page 12 to re-fit the temperature lever and on/off knob.

Should the on/off knob need to be removed at any time, turn the knob fully off with the lever pointing in the 12 o'clock position. Unscrew the lever and set aside. Insert a 2.5mm hexagonal key into the lever fixing position and loosen the grub screw to enable the knob to be pulled clear.

Trouble shooting guide

Symptom	Possible cause	Action
Water output is either all hot or all cold, or cold only	Reversed inlet supplies	Check that the supplies correspond with the inlet markings
Water output is not hot enough	The temperature of the hot water cylinder is too low	The cylinder temperature should be at least 15°C hotter than the blend
	Water flow through the hot water appliance is too fast	Check the flow rate recommendations with the heater manufacturer
	Water flow through the hot water appliance is too fast (Bath/shower mixers on combination boiler systems)	Adjust the flow control knob on the mixer valve to reduce flow until a comfortable showering or bathing temperature is achieved
Flow rate is poor and water temperature is low	Airlock in the hot water supply	Check that the pipe work is laid out in accordance with correct practices, paying particular attention to potential air-traps
Water temperature swings regularly between hot and cold	Cold water pressure is too high	If the static water pressure exceeds 10 bar, install a pressure reducing valve (PRV) in accordance with the installation guide
	The flow regulator has not been fitted (Combi boiler systems)	Fit the flow regulator
Poor flow rate	Twisted hose Debris in shower head Debris in filters Debris in cold inlet flow regulator (combi boiler systems)	Check for debris and clear as necessary



AQUALISA

Aqualisa Products Limited
The Flyer's Way
Westerham Kent TN16 1DE

Customer helpline: 01959 560010
Brochure Hotline: 0800 652 3669
Website: www.aqualisa.co.uk
Email: enquiries@aqualisa.co.uk

Republic of Ireland
Sales enquiries: 01-864-3363
Service enquiries: 01-844-3212



Part No:660601 Issue 01 Jan 11

Please note that calls may be recorded for training and quality purposes

The company reserves the right to alter, change or modify the product specifications without prior warning

© Registered Trademark Aqualisa Products Limited

plumbworld
Big brands, small prices.

Pdf Supplied By <http://www.plumbworld.co.uk/>