

Papillon PAX 654 Specifications

- **Unique Double-Edge profile and corner radii.** Sink lies completely flat on worktop and cloths will not snag on corners
- **2 x 90mm Waste with Basket Strainer Waste.** Capable of adaptation to take Waste Disposal Unit
- **Accessories colour-keyed in White, Blue or Black**
- **Available as a Designer Pack**

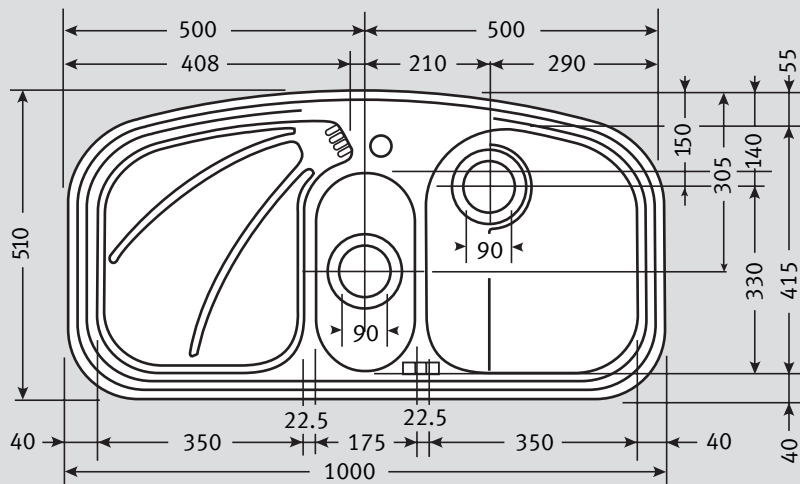

Material:	Stainless Steel
Application:	Inset or undermount
Bowl size:	350 x 415 x 180 } Bowls welded to frame 175 x 330 x 130 }
Drainer Format:	Left or right hand drainer available
Cut-out size:	980 x 490 (utilise template)
Colour:	Silk Stainless Steel
Seal:	Factory Fitted Polyurethane Seal
Heat Resistance:	Up to 300°C
Insulation:	Grey Dynaphon for heat and sound
Earthing Point:	Utilise clip boss

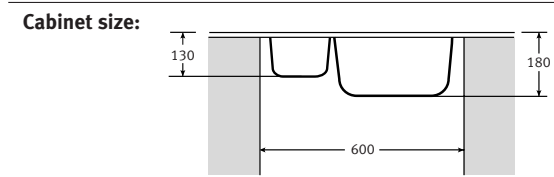

Sink Profile: Double Edge

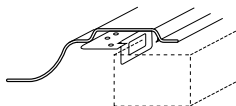

Fixing Clips:

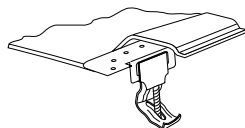

Suggested Plumbing Kit: 2 part

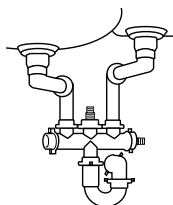

Waste: 1 x Lira 90mm Basket Strainer Waste with overflow
1 x Lira 90mm Basket Strainer Waste

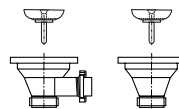

Overflow:



Accessories available:



Strainer Bowl
Available in White, Almond, Blue, Brown or Black



Strainer Bowl
Stainless Steel



Grater*
Stainless Steel

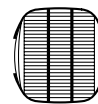

Drainer Grille*
Stainless Steel

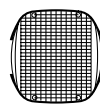

Drainer Basket*
Stainless Steel



Food Preparation Platter*
Hygenia

*Accessories colour-keyed White, Blue or Black.

NB. Shaped Food Preparation Platter not reversible

Taps: Any Franke tap can be utilised with this model*.

*Ceramic disc taps in certain installations or where there is a low head of water (below 4 metres) may not provide adequate flow rates. You are advised to check with your supplier.

Some taps may need bracing to avoid flexing of the sink ledge.

Guarantee: Franke sinks are guaranteed for 25 years against manufacturing defect. Franke taps are guaranteed against defective materials and workmanship for 1 year in relation to coatings and finishes, and 5 years in relation to moving parts. Franke will replace (and where appropriate repair) defective sinks. In relation to taps, Franke will where appropriate provide replacement parts for your taps or replace your taps. Any associated or ancillary costs to be incurred by you as a result of replacement of Franke sinks and taps under this guarantee shall in all cases be previously approved by Franke UK Limited. This guarantee is in addition to and does not affect your statutory rights.

plumbworld
Big brands, small prices.

Pdf Supplied By <http://www.plumbworld.co.uk/>