

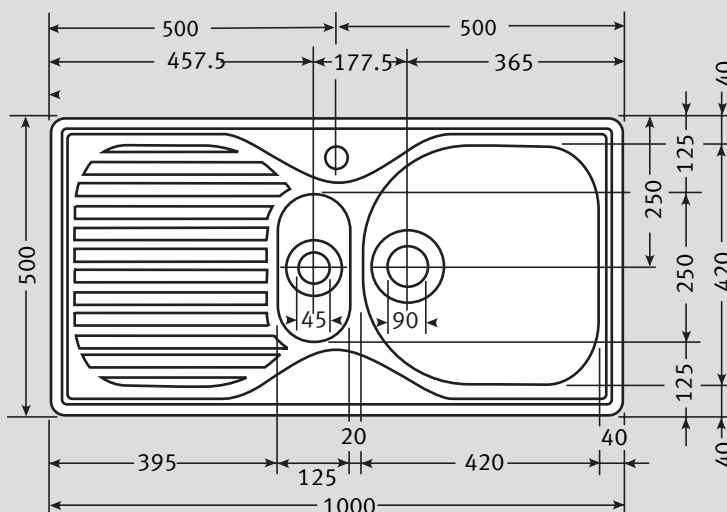

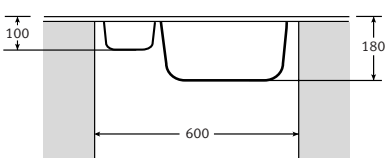

Nobel NOX 651 Specifications

- **Unique Double-Edge profile and corner radii.** Sink lies completely flat on worktop and cloths will not snag on corners
- **1 x 90mm Waste with Basket Strainer Waste.** Capable of adaptation to take Waste Disposal Unit
- **3 colours of accessories available**
- **Small rinsing half bowl**
- **Bespoke accessories**

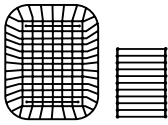
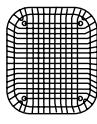

Material:	Stainless Steel	Waste:	1 x Lira Basket Strainer Waste 1 x Lira 45mm Waste with Plug	Overflow:	Not applicable
Application:	Inset or undermount				
Bowl size:	420 x 420 x 180 } 125 x 250 x 100 } Bowls welded to frame				
Drainer Format:	Left or right hand drainer available				
Cut-out size:	984 x 484 (cr=20)				
Colour:	Silk Stainless Steel				
Seal:	Factory Fitted Polyurethane Seal				
Insulation:	Grey Dynaphon for heat and sound				
Heat Resistance:	Up to 300°C				
Earthing Point:	Located at end of clip rail				
Cabinet size:		Accessories available:			
			Strainer Bowl Available in White, Almond, Brown or Black		Drainer Basket/Plate Rack Available in White, Almond, Brown or Black
			Drainer Basket Stainless Steel		Food Preparation Platter Mahogany

Sink Profile: Double Edge

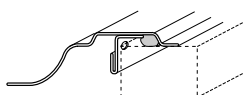

Fixing Clips: 'S' rail

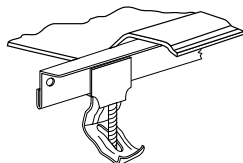

Suggested Plumbing Kit: 2 part

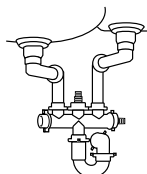

Taps: Any Franke tap can be utilised with this model*.

*Ceramic disc taps in certain installations or where there is a low head of water (below 4 metres) may not provide adequate flow rates. You are advised to check with your supplier.

Some taps may need bracing to avoid flexing of the sink ledge.

Guarantee: Franke sinks are guaranteed for 25 years against manufacturing defect. Franke taps are guaranteed against defective materials and workmanship for 1 year in relation to coatings and finishes, and 5 years in relation to moving parts. Franke will replace (and where appropriate repair) defective sinks. In relation to taps, Franke will where appropriate provide replacement parts for your taps or replace your taps. Any associated or ancillary costs to be incurred by you as a result of replacement of Franke sinks and taps under this guarantee shall in all cases be previously approved by Franke UK Limited.

This guarantee is in addition to and does not affect your statutory rights.

plumbworld
Big brands, small prices.

Pdf Supplied By <http://www.plumbworld.co.uk/>