

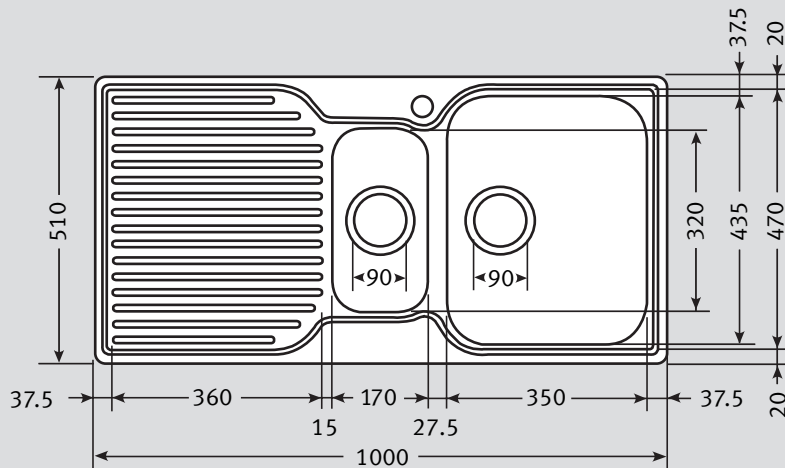





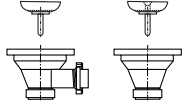

Ariane ARX 651P Specifications

- **Unique Double-Edge profile and corner radii.** Sink lies completely flat on worktop and cloths will not snag on corners
- **2 x 90mm Wastes with Basket Strainer Wastes.** Capable of adaptation to take Waste Disposal Unit
- **Stainless Steel accessories available**
- **Large diagonal bowl dimension.** Extra large main and half bowl located at front rim of sink profile
- **Symmetrical design**

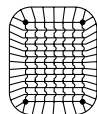

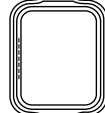
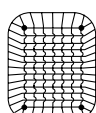
Material:	Stainless Steel	Waste:	1 x Lira 90mm Basket Strainer Waste with overflow 1 x Lira 90mm Basket Strainer Waste	Overflow:	
Application:	Inset				
Bowl Size:	350 x 435 x 180 } Bowls welded to frame 170 x 320 x 135 }				
Drainer Format:	Left or right handed drainer available				
Cut-out Size:	984 x 494 (cr=20)				
Colour:	Silk Finish Stainless Steel	Accessories Available:			
Seal:	Factory Fitted Polyurethane Seal	Strainer Bowl Available in White, Almond, Brown or Black		Drainer Basket Available in White, Almond, Brown or Black	
Insulation:	Black pads for sound insulation	Drainer Tray Available in White, Almond, Brown or Black		Food Preparation Platter Mahogany	
Heat Resistance:	Up to 300°C	Strainer Bowl Stainless Steel			
Earthing Point:	Located at end of clip rail				
Cabinet Size:		Sink Profile: Double Edge			
		Fixing Clips: 'S' rail			
Suggested Plumbing Kit: 2 part					
			Taps: Any Franke tap can be utilised with this model*.		
			*Ceramic disc taps in certain installations or where there is a low head of water (below 4 metres) may not provide adequate flow rates. You are advised to check with your supplier.		
			Some taps may need bracing to avoid flexing of the sink ledge.		

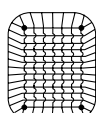
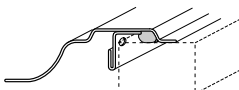
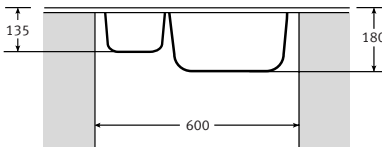
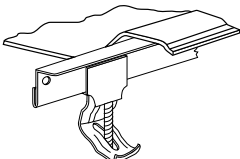
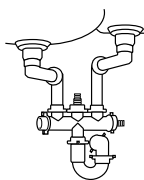
Guarantee: Franke sinks are guaranteed for 25 years against manufacturing defect. Franke taps are guaranteed against defective materials and workmanship for 1 year in relation to coatings and finishes, and 5 years in relation to moving parts. Franke will replace (and where appropriate repair) defective sinks. In relation to taps, Franke will where appropriate provide replacement parts for your taps or replace your taps. Any associated or ancillary costs to be incurred by you as a result of replacement of Franke sinks and taps under this guarantee shall in all cases be previously approved by Franke UK Limited. This guarantee is in addition to and does not affect your statutory rights.

plumbworld
Big brands, small prices.

Pdf Supplied By <http://www.plumbworld.co.uk/>