

# Vita VIX 611 Specifications

- 1 x 45mm Waste with overflow
- Reversible single bowl sink
- Modern drainer design
- Size accommodates tight situations

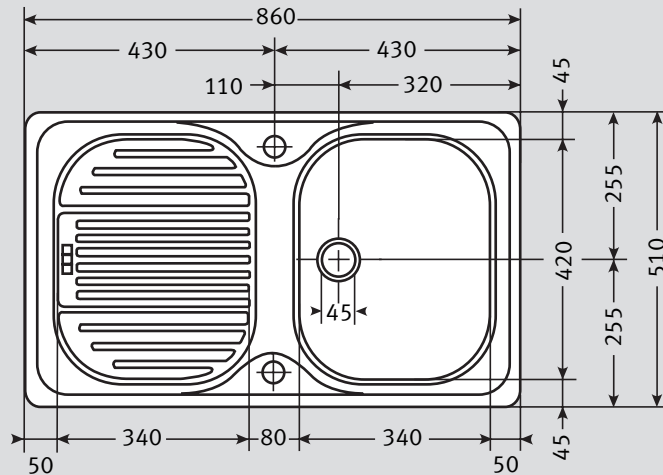

<b>Material:</b>	Stainless Steel
<b>Application:</b>	Inset
<b>Bowl Size:</b>	340 x 420 x 175
<b>Drainer Format:</b>	Reversible
<b>Cut-out Size:</b>	844 x 494 (cr=20)
<b>Colour:</b>	Brushed Stainless Steel
<b>Seal:</b>	Apply locally
<b>Insulation:</b>	Black pads under bowl and drainer for sound insulation
<b>Heat Resistance:</b>	Up to 300°C
<b>Earthing Point:</b>	Utilise clip rail slots

**Waste:** 1 x Lira 45mm Waste with plug and chain

**Overflow:**

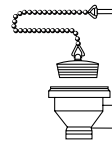

**Cabinet Size:**

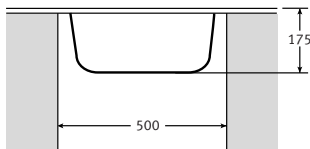

**Sink Profile:** Folded Edge

**Fixing Clips:**

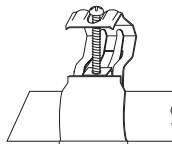
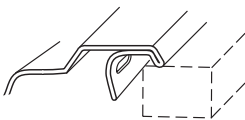

**Suggested Plumbing Kit:** 1 part

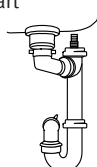

**Accessories Available:**



**Chopping Board**  
Mahogany

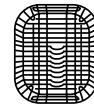

**Drainer Basket**  
Available in White, Almond and Brown

**Taps:** Any Franke tap can be utilised with this model\*.

\*Ceramic disc taps in certain installations or where there is a low head of water (below 4 metres) may not provide adequate flow rates. You are advised to check with your supplier.

Some taps may need bracing to avoid flexing of the sink ledge.

**Guarantee:** Franke sinks are guaranteed for 25 years against manufacturing defect. Franke taps are guaranteed against defective materials and workmanship for 1 year in relation to coatings and finishes, and 5 years in relation to moving parts. Franke will replace (and where appropriate repair) defective sinks. In relation to taps, Franke will where appropriate provide replacement parts for your taps or replace your taps. Any associated or ancillary costs to be incurred by you as a result of replacement of Franke sinks and taps under this guarantee shall in all cases be previously approved by Franke UK Limited. This guarantee is in addition to and does not affect your statutory rights.

**plumbworld**  
**Big brands, small prices.**

Pdf Supplied By <http://www.plumbworld.co.uk/>