

# Installation Instructions for Axial Fans for Bathroom, Toilets, Utility Rooms and Kitchens

## AXS100, AXS100SELV, AXSU & AXSK

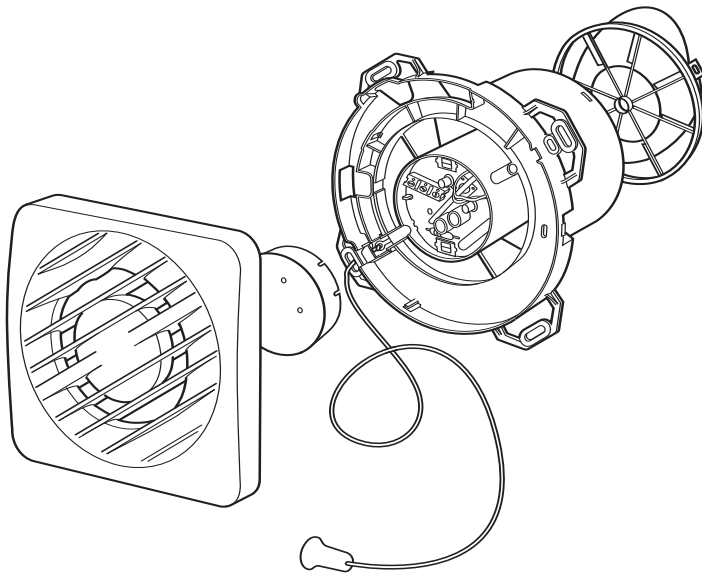

### READ ALL INSTRUCTIONS BEFORE COMMENCING INSTALLATIONS

- Observe appropriate safety precautions if working on steps or ladders. Wear eye protection when breaking out wall or window materials etc.
- Siting Notes:  
Where an open-flued oil or gas-fuelled appliance is installed in the kitchen, extract ventilation can cause the spillage of flue gases. Care must be taken to ensure ventilation is reduced as appropriate, as set out in the building regulations. The guide to the regulations suggests that the reduced provision should be an extract rate 20 l/s (72 m<sup>3</sup>/h) maximum. Kitchens with solid-fuel appliances should not have extract fans fitted.
- The fans should not be sited where it would be subject to a direct source of heat in excess of 40°C.
- When installing wall mounted fans, ensure that there are no buried cables or pipes in the way. It is recommended that this fan is mounted 1.8m above floor level.
- A clearance of 75mm to be allowed on at least one side of the fan for the removal of the internal grille.
- Cleaning Notes:  
Always isolate from the mains before cleaning. Do not use solvents to clean the fan. Wipe the front grille clean using a damp cloth avoiding getting any water into the internal fan unit.

### WALL MOUNTING

(Using ED wall duct and EG external grille)

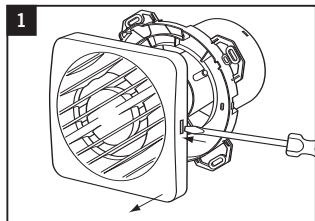

Remove one piece Internal Grille using screwdriver. Push in to free catch then twist to remove grille.

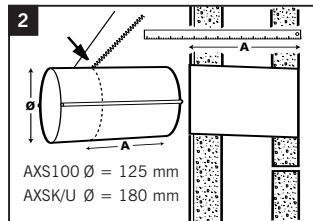

Cut the duct to width of the plasterboard or tiled wall with slight fall to exterior. (Make provisions for cable).  
AXS100  $\varnothing$  = 125 mm  
AXSK/U  $\varnothing$  = 180 mm

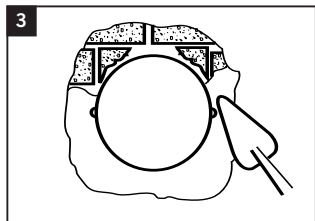

Fill in any gaps with mortar or foam and make good internal and external walls. Make sure that ducting remains circular and screw holes are horizontal.

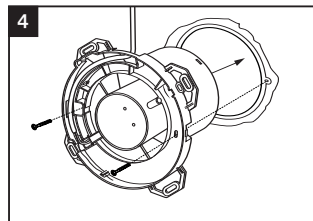

Using No 8 screws, secure fan body to ducting first making sure back draught shutter is fitted, if required, and electrical cable passes through as appropriate. Wire fan (See wiring details).

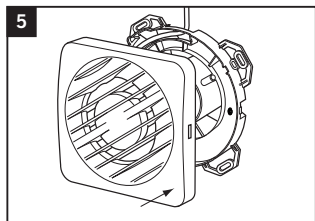

Replace internal grille ensuring no wires are trapped.

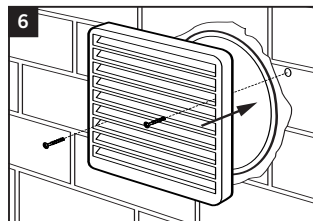

Screw the protective wall grille over the external duct opening.

### CEILING MOUNTING

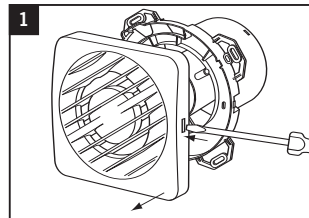

Remove one piece Internal Grille using screwdriver. Push in to free catch then twist to remove grille.

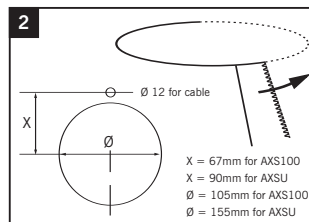

Cut an opening through the ceiling for the fan and electrical cable.

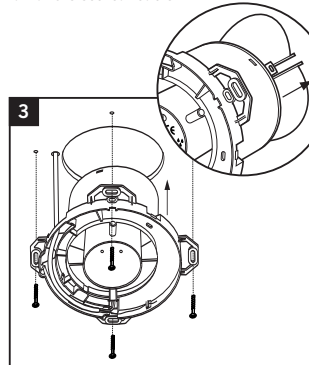

Secure to ceiling using suitable screws first making sure backdraught shutters are removed but shutter spider is left in position. Wire fan (See wiring details).

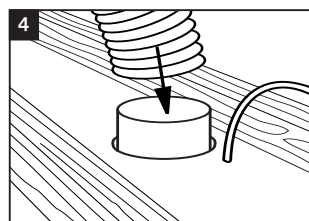

Place flexible ducting over the spigot of the fan.

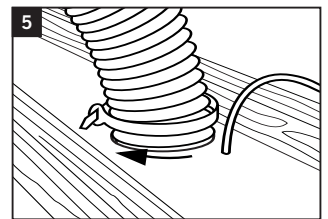

Fit ducting to spigot using ties supplied, making sure impeller rotates freely.

Maximum duct length to comply with Building Regulations:

AXS100: 3m  
AXSU: 12m  
AXSK: Wall mounting only

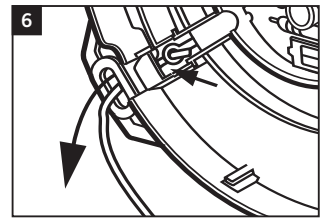

Detach the cord from the pcb by pulling the cord through the pull cord's link.

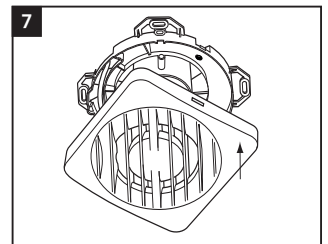

Replace internal grille ensuring no wires are trapped.

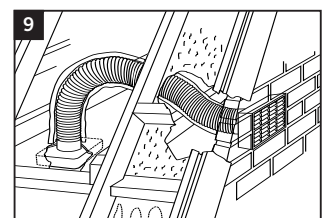
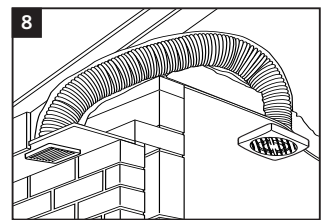

**WIRING DETAILS**

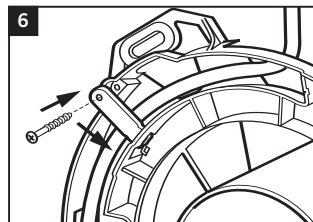
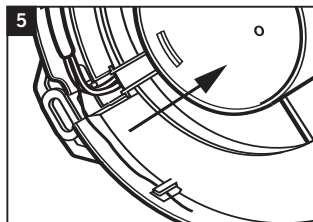
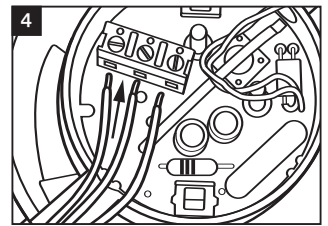
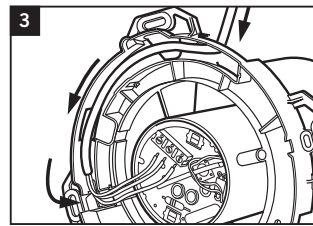
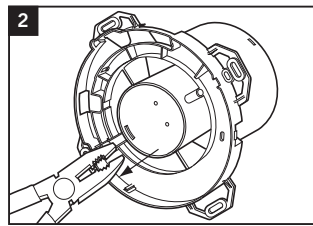
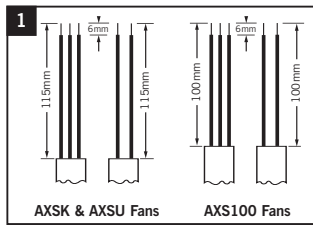

Before commencing wiring remove centre safety cover over PCB using a pair of pliers. Refit safety cover on completion of wiring by pushing home.

Note: If cable is supplied with earth core this can be cut to the same length and 'parked' as shown in diagram 5.

If fixed flat cable is used or flexible cable which is secured with suitable wall fixings the cable clamp is not required.

If flexible cable is used without suitable fixings use cable clamp and screw supplied loose with the fan (diagram 6).

For SELV fans only

Maximum cable length between fan and controller:

Conductor Size	Maximum length
0.75mm <sup>2</sup>	2.3m
1.00mm <sup>2</sup>	3.0m

**WIRING DIAGRAMS**

The electrical connections must be carried out by a qualified electrician in accordance with IEE or local regulations.

**WARNING: Isolate electricity supply before starting work.**

- The fans are double insulated and do not require an earth connection.
- The fans must be connected to a double pole isolating switch having contact separation of at least 3 mm.
- When supplied from a 5 amp lighting circuit no local fuse is required.

Specification: 230 V ~ 50 Hz.

Consumption: AXS100 – 16W  
AXS100SVI – 20W  
AXSK/U – 35W

Cable Sizes:

Fixed flat wiring 2 core 1mm<sup>2</sup>  
3 core 1/1.5mm<sup>2</sup>

Flexible round wiring 2 core 0.75mm<sup>2</sup>  
3 core 0.75mm<sup>2</sup>

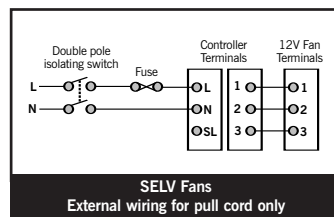
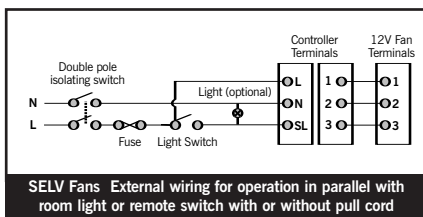
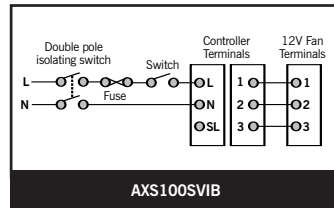
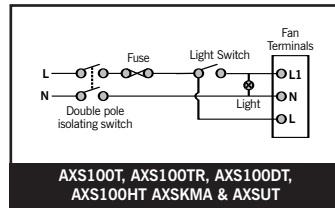
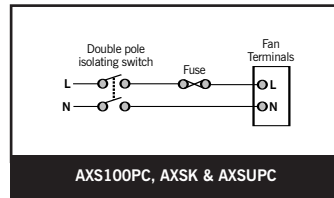
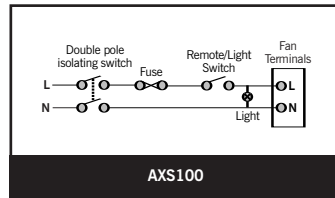

**SELV FANS ONLY TO WIRE THE CONTROLLER**

Remove the electrical cover.

Make all connections to the connector blocks.

**Note:** Mains cable must be fixed back to the wall using appropriate cable cleats.

Replace electrical cover

**Note:** Do not fit more than one fan to the controller or connect with any other product. This equipment must be sited away from direct water spray and heat in excess of 40°C the controller must not be sited within reach of a person using a bath or shower nor within a shower cubicle/enclosure.

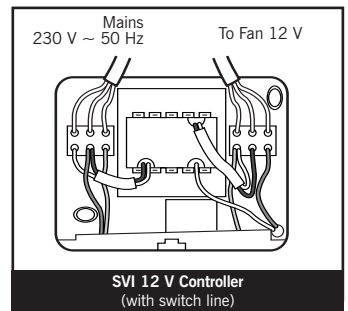

**SENSOR/TIMER ADJUSTMENTS**

**Note: Switch off the mains electricity before adjusting controls.**

- 1 Remove one piece Internal Grille using screwdriver. Push in to free catch then twist to remove grille.
- 2 The timer is pre-set but may be adjusted by using a screwdriver and rotating clockwise to increase time and anti-clockwise to reduce time overrun.

The humidity sensor is pre-set but may be adjusted by using a screwdriver and rotating clockwise to increase the sensitivity and anti-clockwise to reduce the sensitivity.

- 3 After adjustments replace Internal Grille by pushing home.

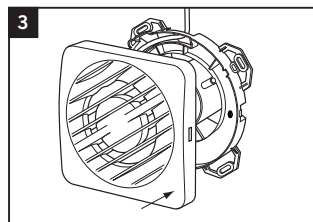
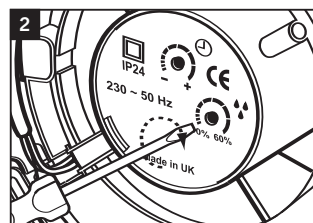
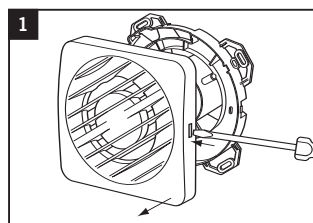

**TO CLEAN OR SERVICE FAN**

- Remove one piece Internal Grille using screwdriver. Push in to free catch then twist to remove grille.
- The fan may now be cleaned using a brush or damp cloth. DO NOT IMMERSE IN WATER.
- After cleaning replace Internal Grille by pushing home.

**WARNING: Always isolate fan from mains supply before cleaning. Do not use solvents to clean this fan.**